



US00D340165S

United States Patent [19]

[11] Patent Number: **Des. 340,165**

Blake

[45] Date of Patent: **** Oct. 12, 1993**

[54] **COMBINED SQUEEZE BOTTLE AND CARRIER**

D. 282,234 1/1986 Henderson D7/608
D. 295,709 5/1988 Evans et al. D7/620

[76] Inventor: **Charles E. Blake, 9632 E St., Oakland, Calif. 94603**

*Primary Examiner—Terry A. Pfeffer Wallace
Attorney, Agent, or Firm—Leon Gilden*

[**] Term: **14 Years**

[57] **CLAIM**

[21] Appl. No.: **669,344**

The ornamental design for a combined squeeze bottle and carrier, as shown and described.

[22] Filed: **Mar. 14, 1991**

DESCRIPTION

[52] U.S. Cl. **D7/510; D7/620**

[58] Field of Search **D7/619-623,
D7/510; D9/455; D12/114; 220/737;
229/103.1**

FIG. 1 is a front elevational view of a combined squeeze bottle and carrier showing my new design;
FIG. 2 is a rear elevational view thereof;
FIG. 3 is a left side elevational view thereof;
FIG. 4 is a right side elevational view thereof;
FIG. 5 is a top plan view thereof;
FIG. 6 is a bottom plan view thereof; and,
FIG. 7 is a perspective view thereof.

[56] **References Cited**

U.S. PATENT DOCUMENTS

D. 272,139 1/1984 Boughton D7/620 X

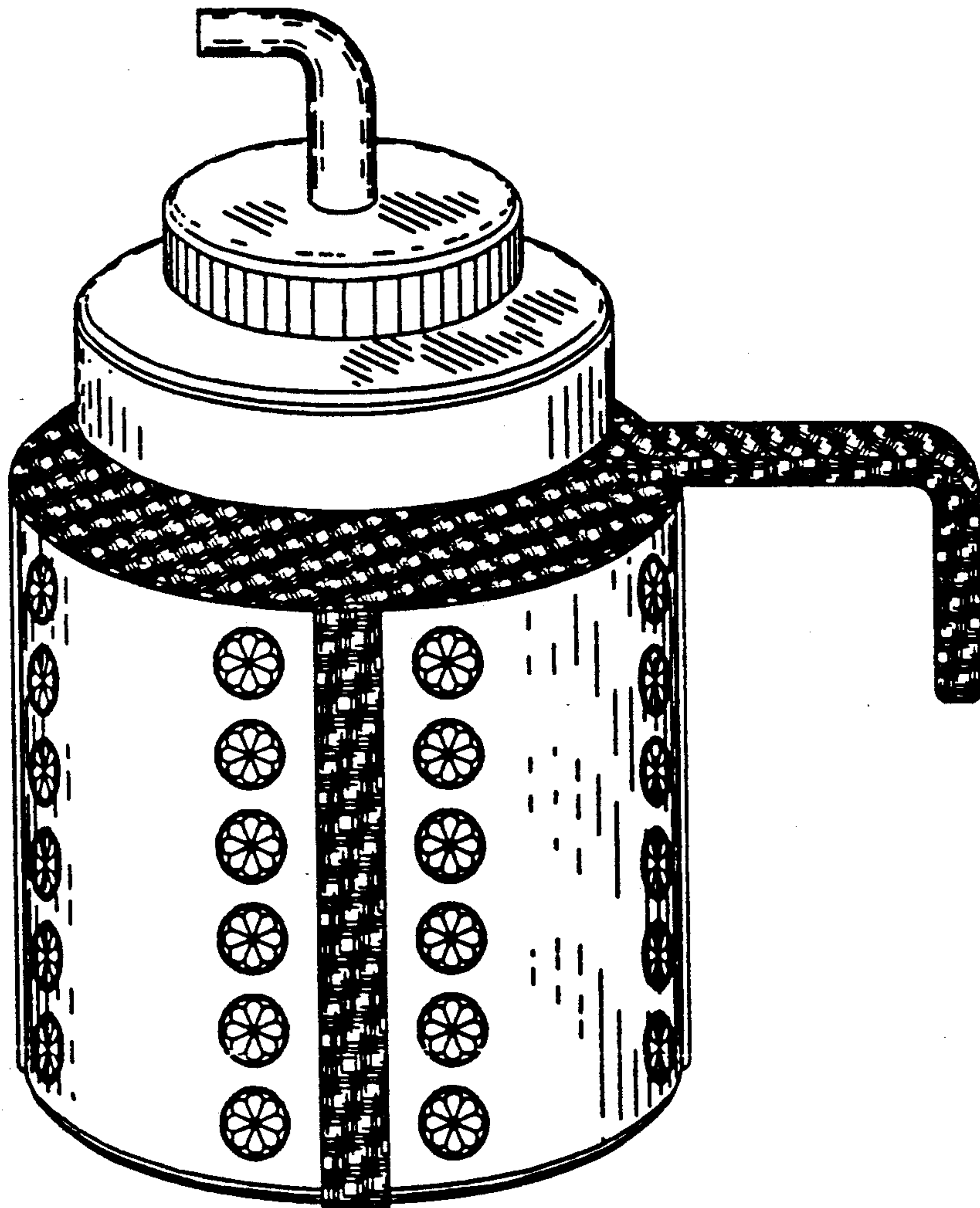

FIG. 1

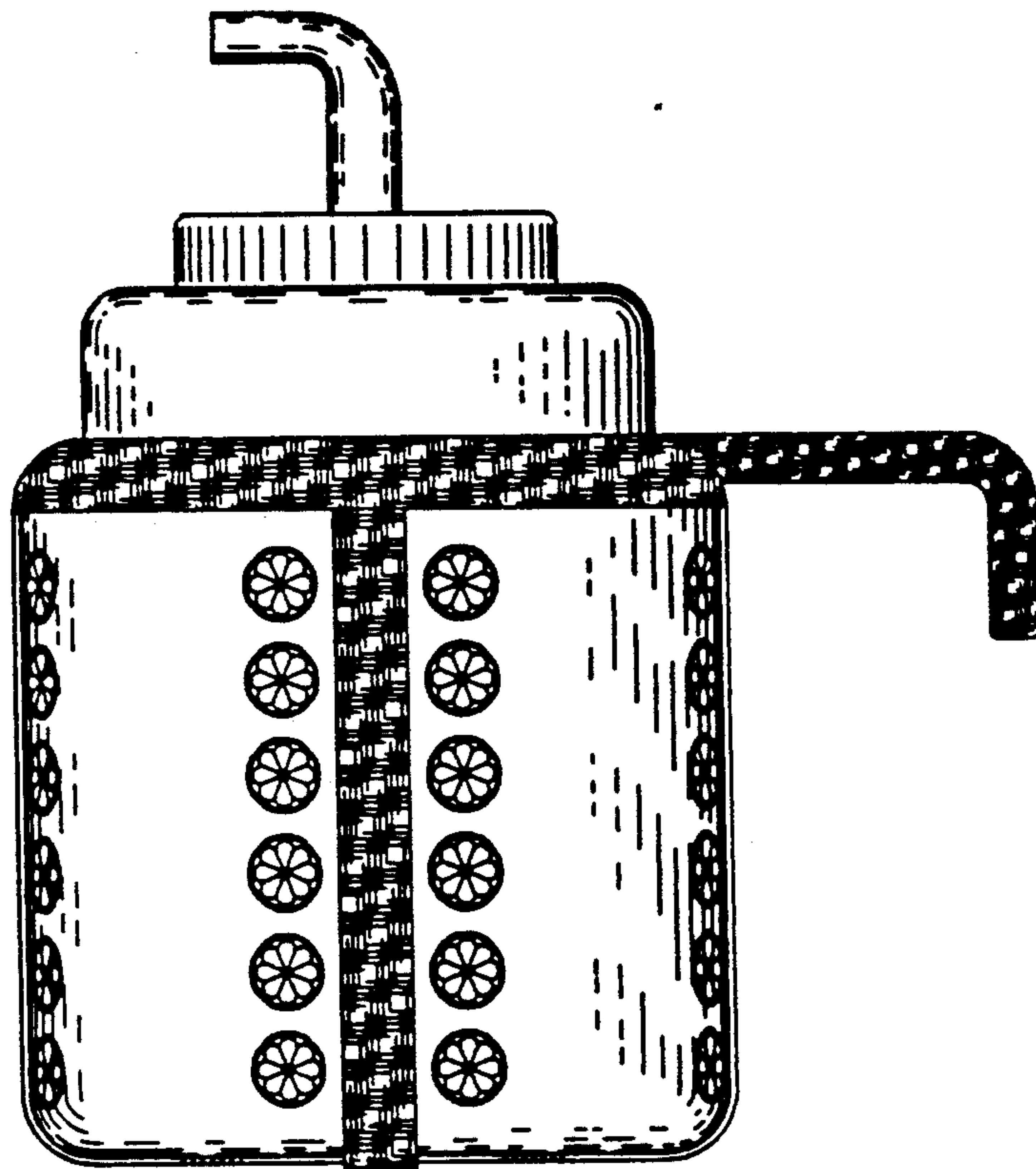

FIG. 2

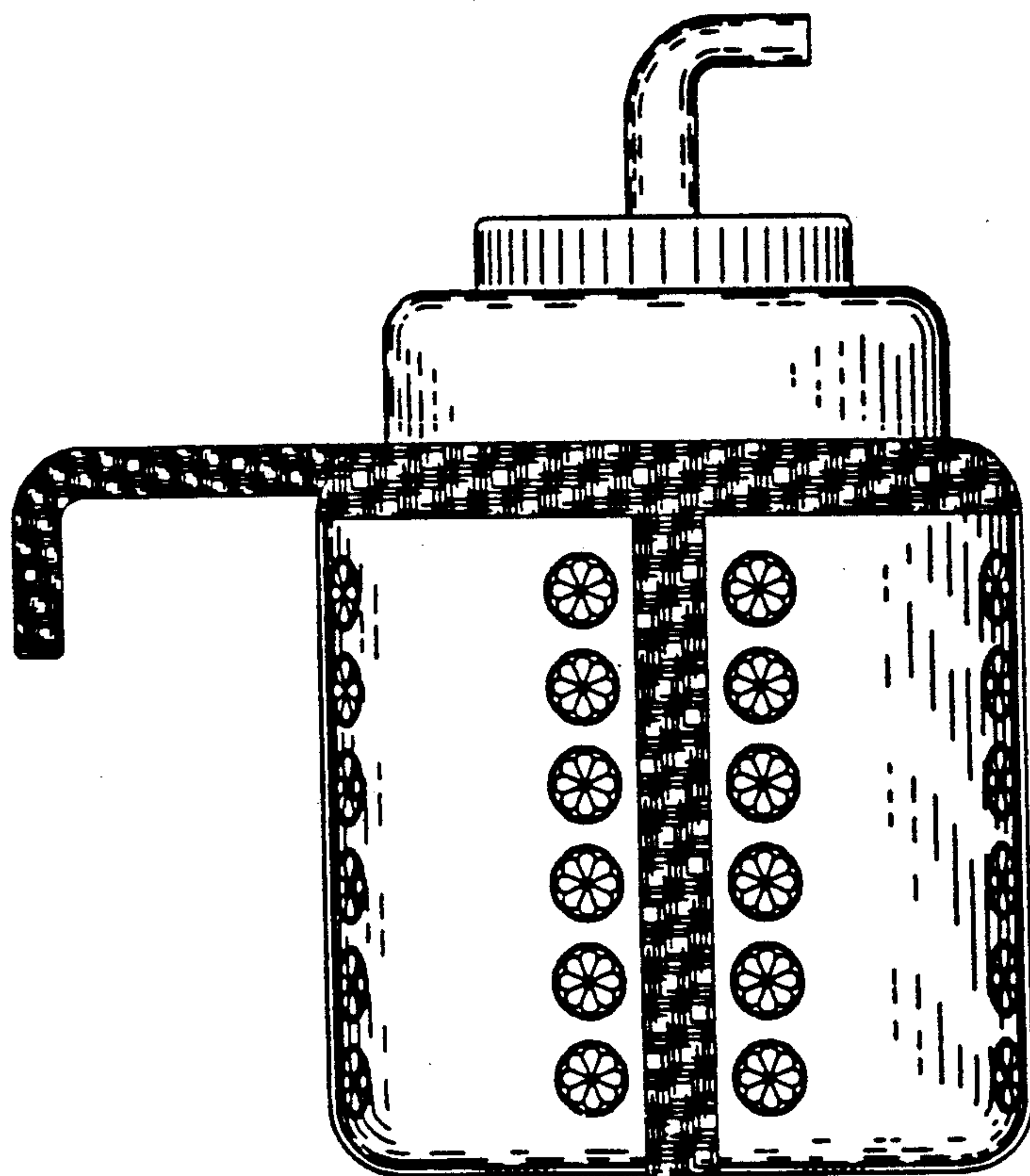

FIG. 3

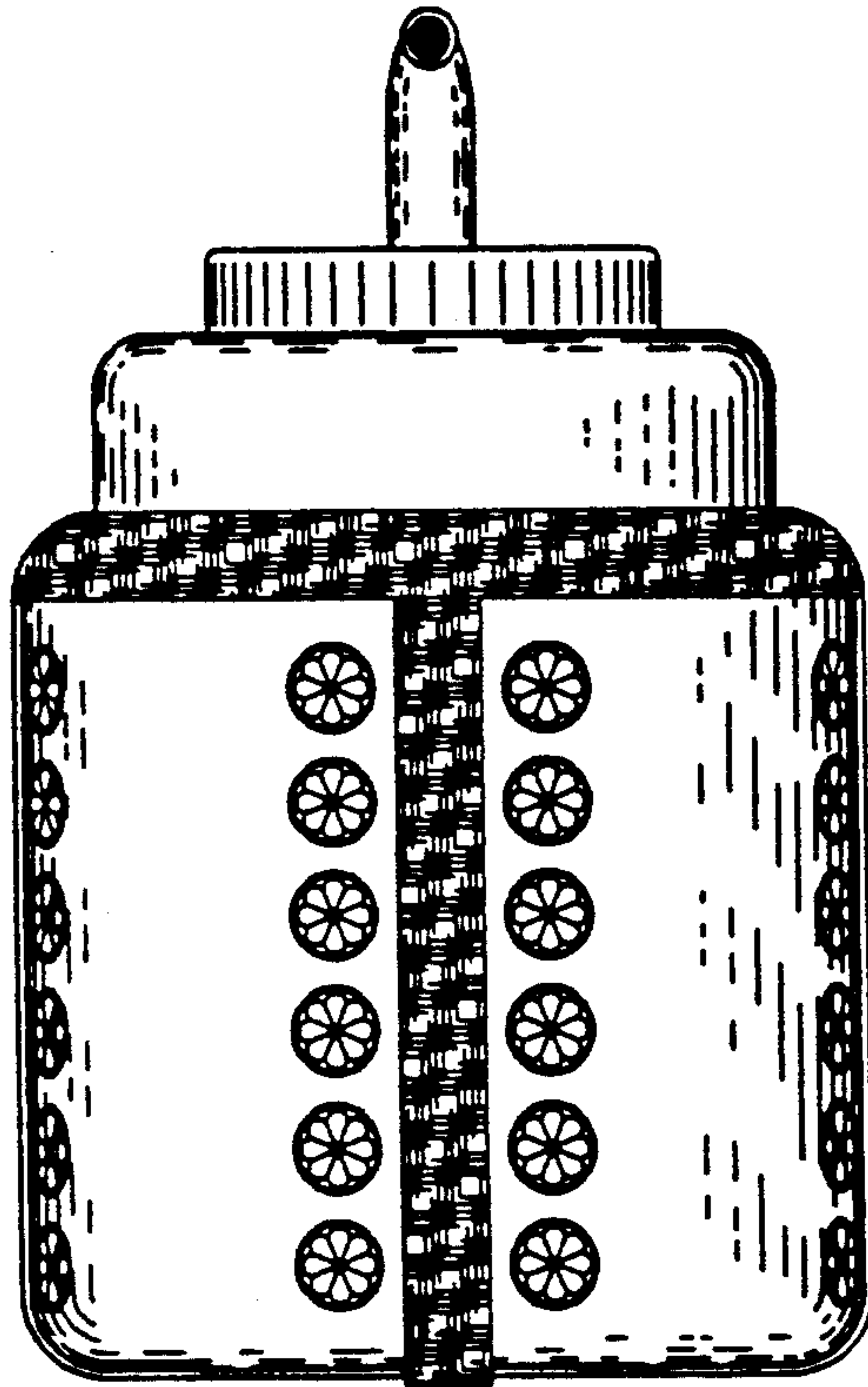

FIG. 4

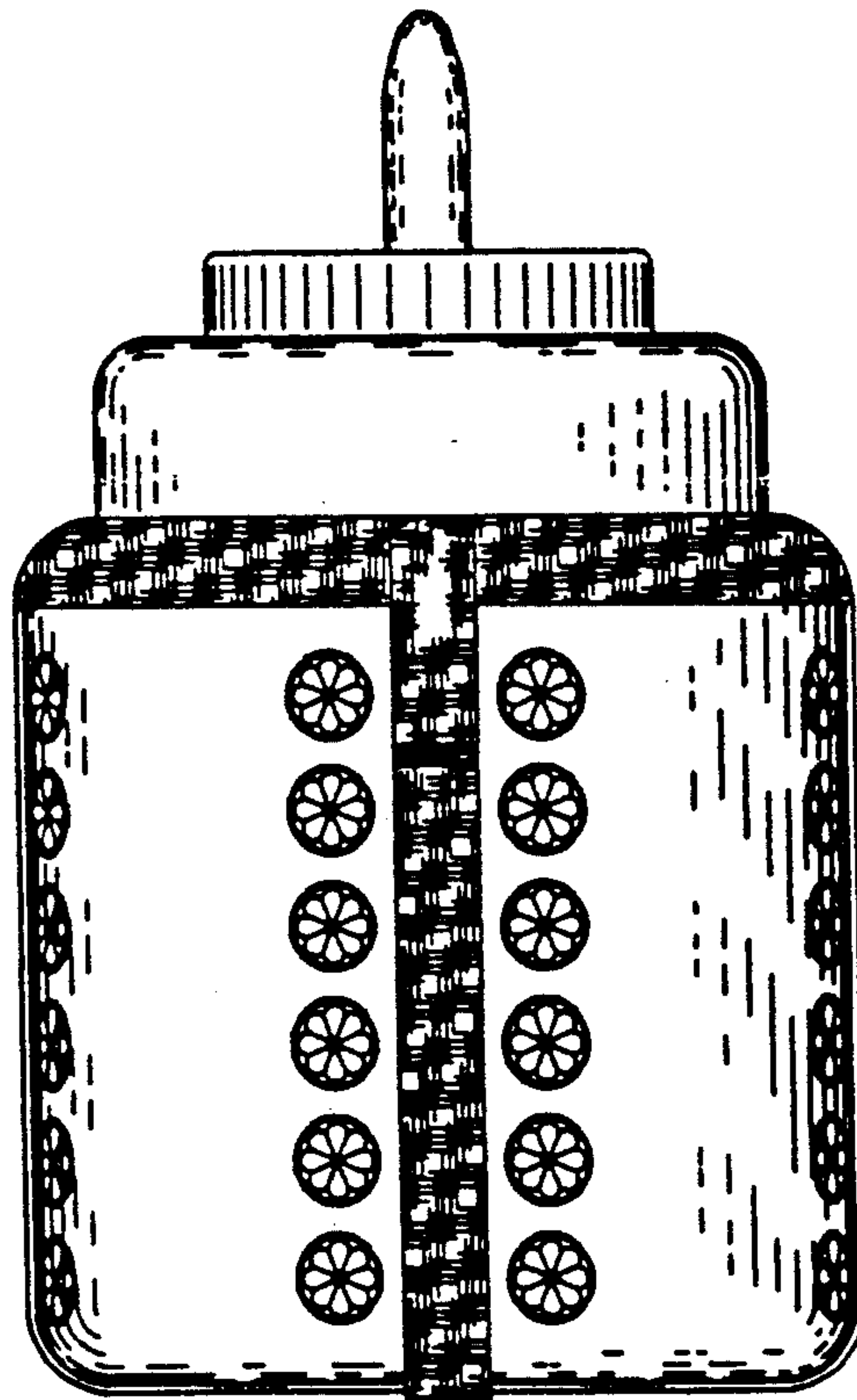

FIG. 5

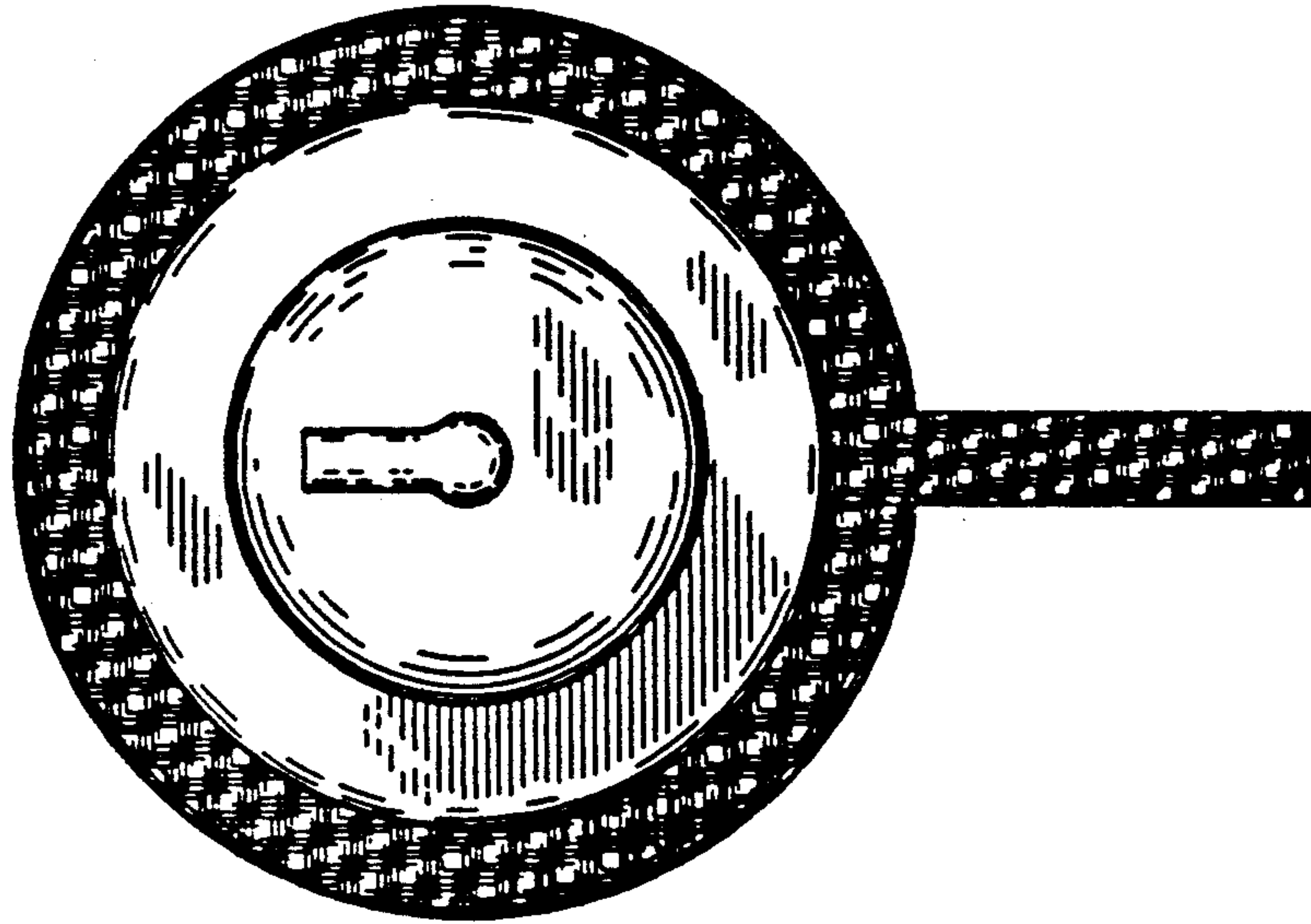

FIG. 6

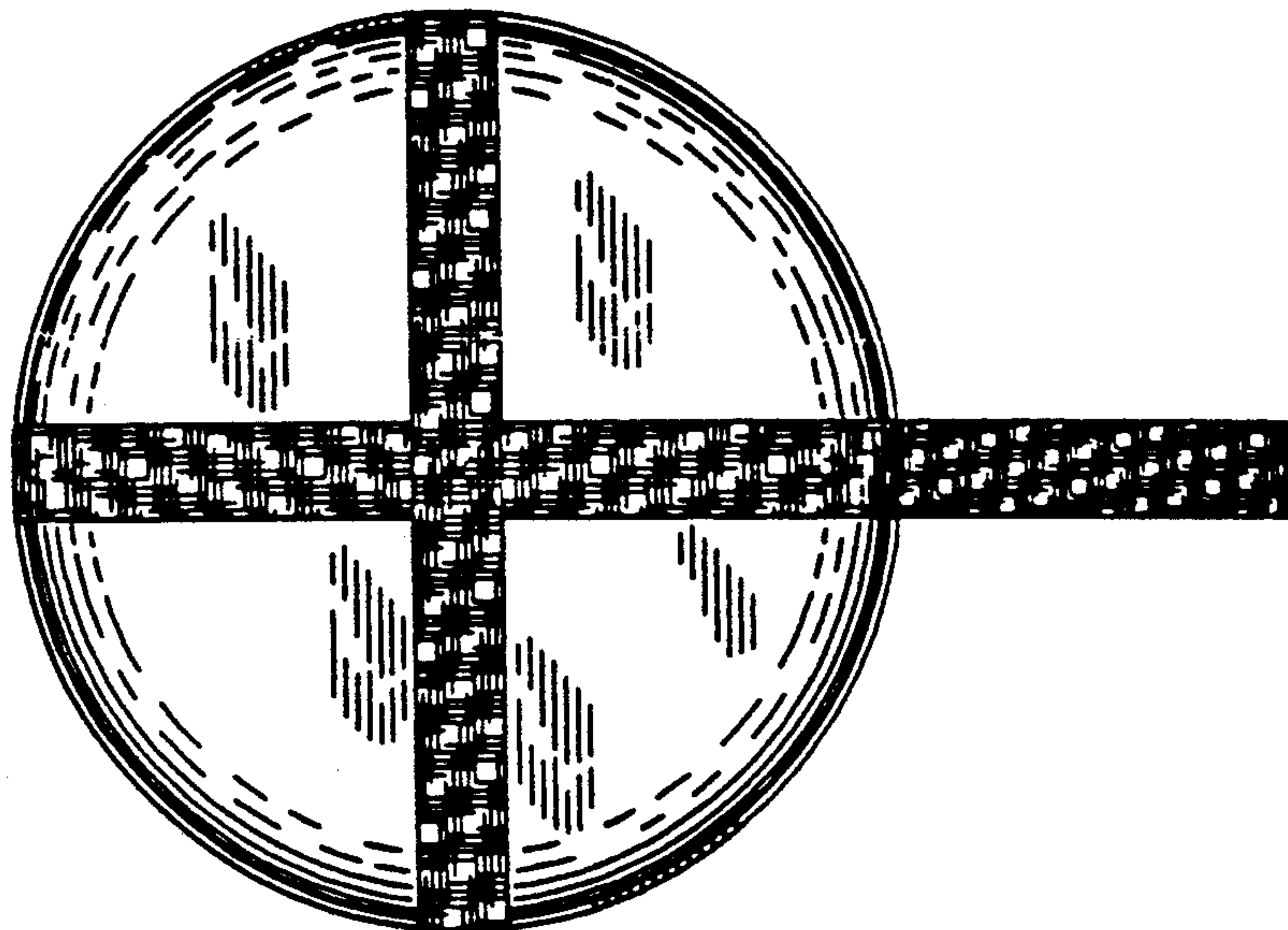

FIG. 7

