



US00D339951S

# United States Patent [19]

[11] Patent Number: **Des. 339,951**

Parkison et al.

[45] Date of Patent: **\*\* Oct. 5, 1993**

## [54] SPORTS TOWEL WITH POCKET

[76] Inventors: **Gary A. Parkison; Brinda K. Parkison**, both of 12185 SW. Calico Ct. Apt G, Beaverton, Oreg. 97005

[\*\*] Term: **14 Years**

[21] Appl. No.: **643,658**

[22] Filed: **Jan. 18, 1991**

[52] U.S. Cl. .... **D6/608**

[58] Field of Search ..... D6/608, 595, 596; D3/100, 104, 36; D2/229, 225; 2/69, 69.5; 5/644, 417, 420, 419, 656; 383/24, 4, 40; 15/210 R, 209

## [56] References Cited

### U.S. PATENT DOCUMENTS

D. 275,816	10/1984	Robinson, Jr. ....	D3/104
D. 316,177	4/1991	Strimpfel .....	D3/100
2,754,532	7/1956	Kanehl et al. .	
3,552,610	1/1971	Coleman et al. ....	D3/100
4,771,478	9/1988	Bisagno et al. ....	2/69
4,815,154	3/1989	Grimes .....	5/644

## OTHER PUBLICATIONS

Peerless Imported Rugs Adv. Flyer, p. 3, Sailboat Rug A, bottom right side of page.

*Primary Examiner*—Wallace R. Burke  
*Assistant Examiner*—Lisa Lichtenstein  
*Attorney, Agent, or Firm*—Leon Gilden

## [57] CLAIM

The ornamental design for a sports towel with pocket, as shown.

## DESCRIPTION

FIG. 1 is a front elevational view of a sports towel with pocket showing our new design;  
FIG. 2 is a rear elevational view thereof;  
FIG. 3 is an enlarged left side elevational view thereof;  
FIG. 4 is an enlarged right side elevational view thereof;  
FIG. 5 is an enlarged top plan view thereof;  
FIG. 6 is an enlarged bottom plan view thereof; and,  
FIG. 7 is an enlarged top, left side and front perspective view thereof.

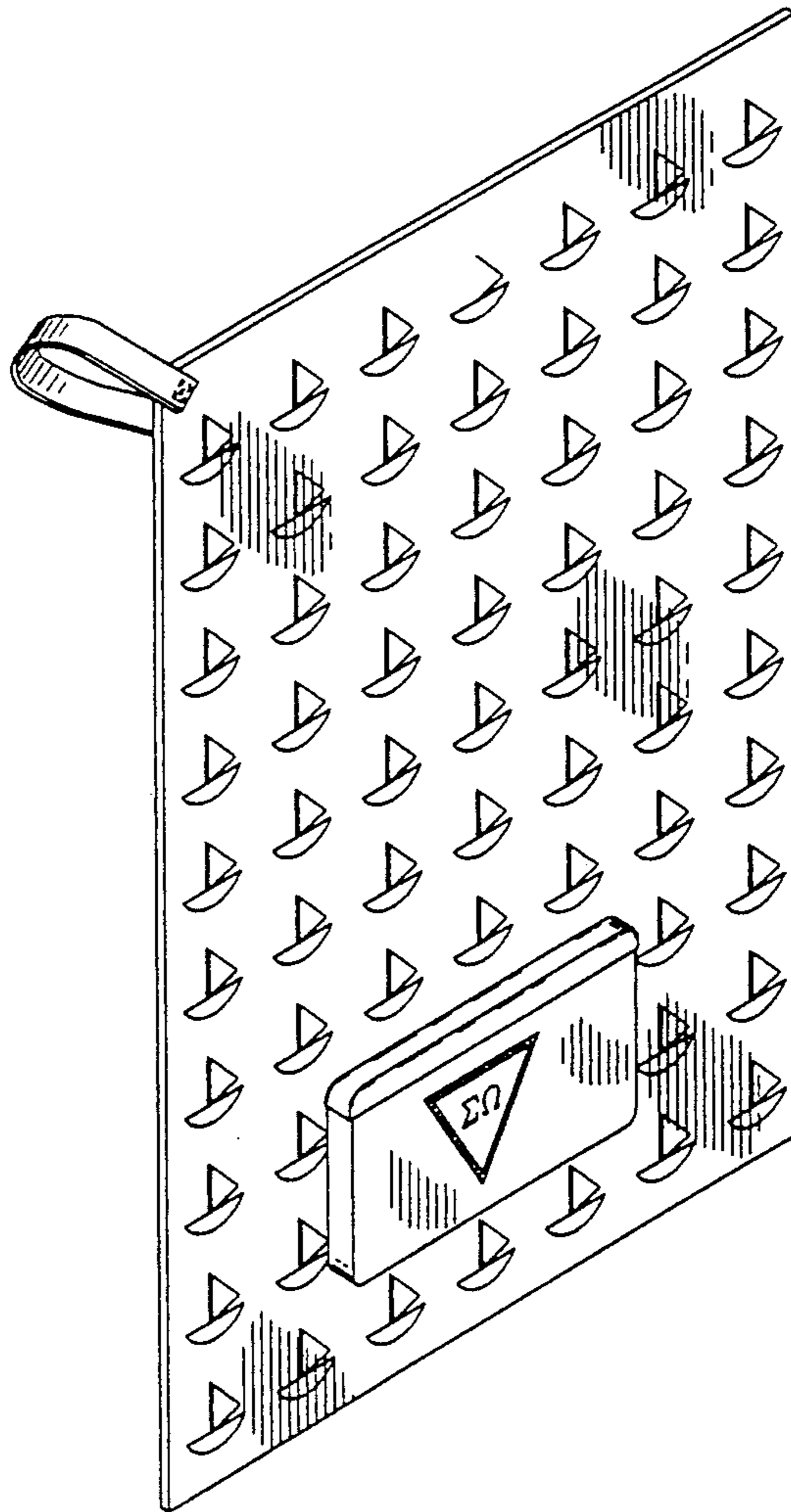

FIG. 1

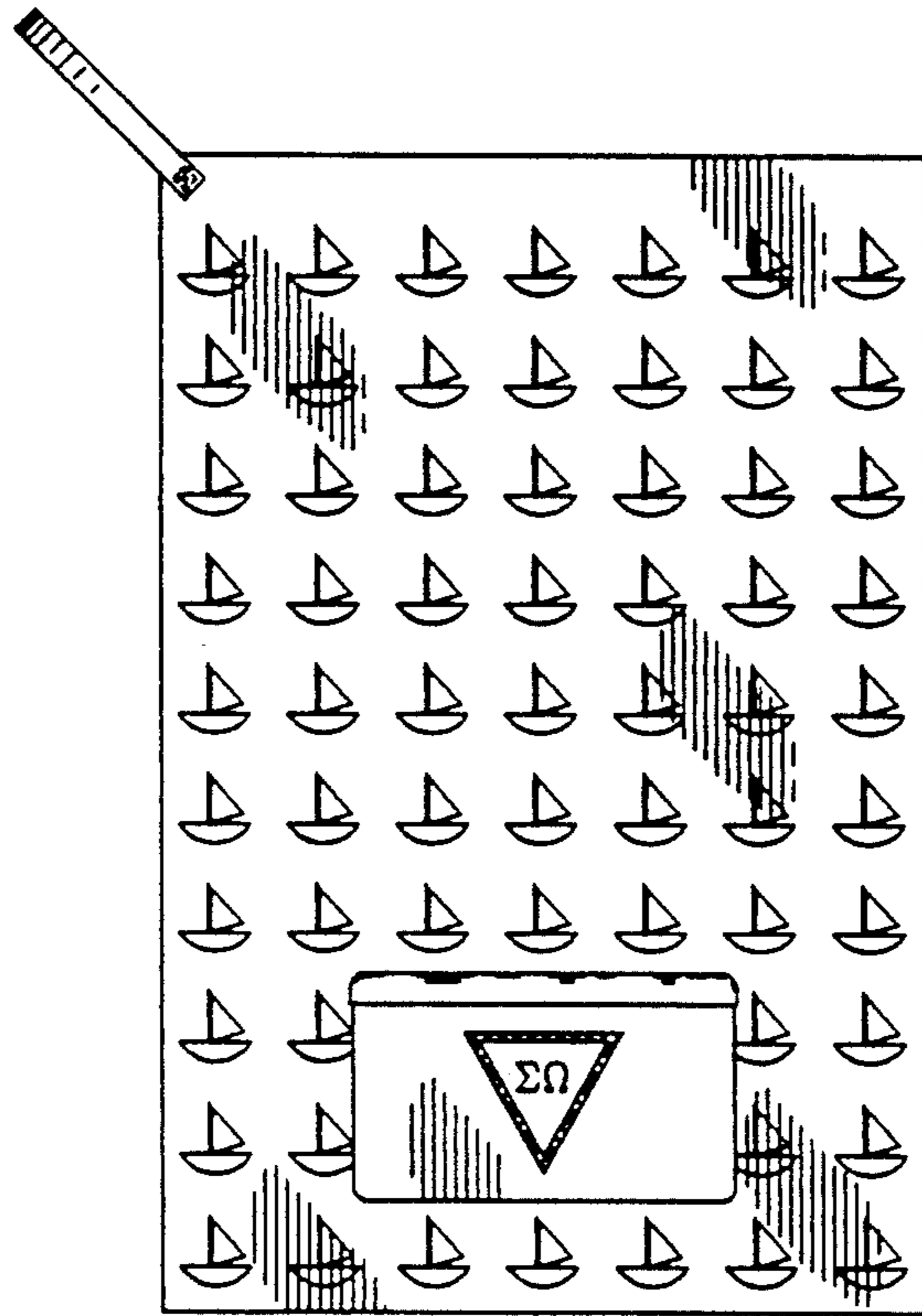

FIG. 2

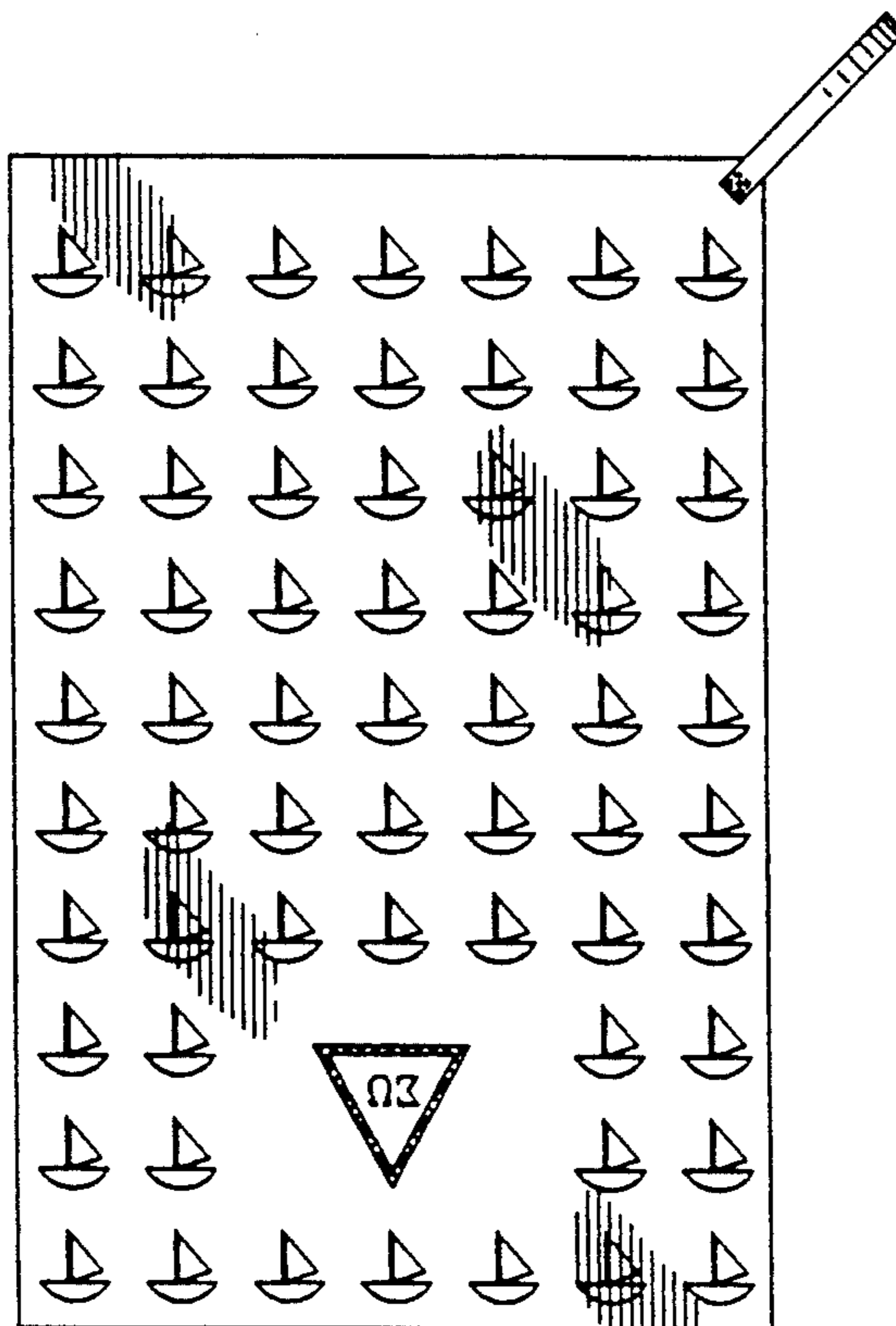

FIG. 3

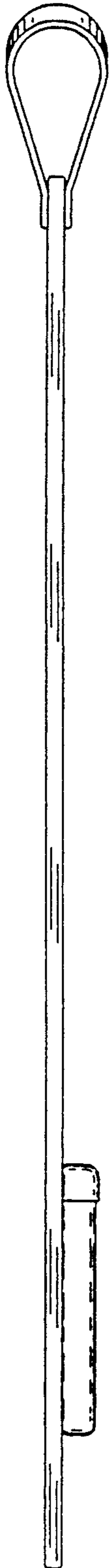

FIG. 4

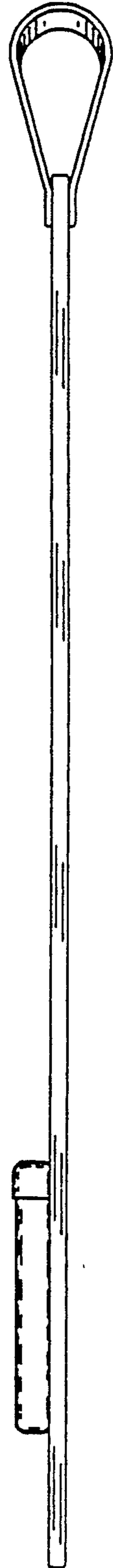

FIG. 5

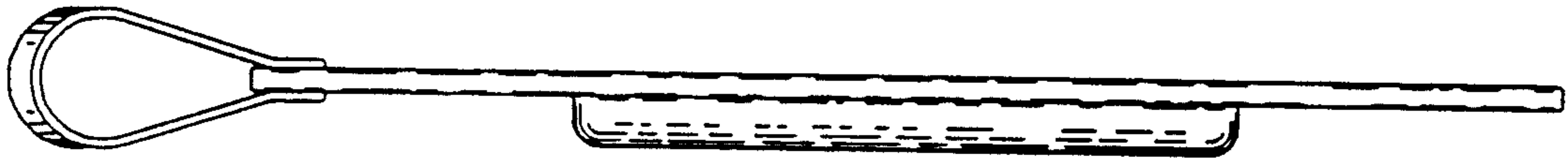

FIG. 6

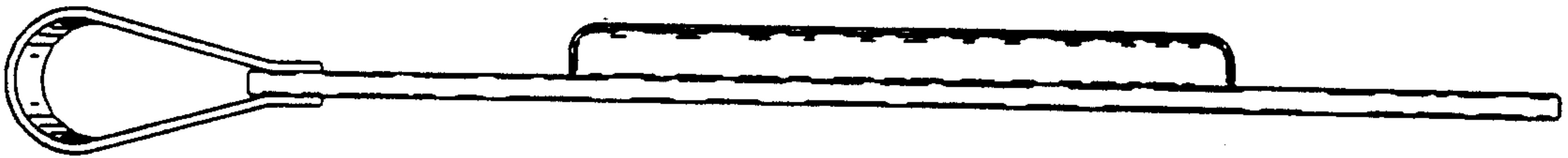

FIG. 7

