



US00D339872S

United States Patent [19]

[11] Patent Number: Des. 339,872

Landaluce-Echevarria

[45] Date of Patent: ** Sep. 28, 1993

[54] BUS STOP MARQUEE

[76] Inventor: Francisco J. Landaluce-Echevarria,
Caserio Olondo - B Matiena, 48220
Abadiano, Spain

[**] Term: 14 Years

[21] Appl. No.: 322,707

[22] Filed: Mar. 13, 1989

[52] U.S. Cl. D25/26

[58] Field of Search D25/56, 57, 1, 18, 16;
52/36, 38, 18, 63, 86, 89

[56] References Cited

U.S. PATENT DOCUMENTS

D. 227,662	7/1973	Warshaw et al.	D25/18
1,796,233	3/1931	Barns	52/38 X
2,988,810	6/1961	Wilken	52/86
3,421,269	1/1969	Medow	52/86
3,608,252	9/1971	Bisson	52/86 X
3,968,604	7/1976	Hills	52/86
4,075,797	2/1978	Shaw	52/38 X
4,669,233	6/1987	Minter	52/86
4,745,713	5/1988	Gotoh	52/86 X

OTHER PUBLICATIONS

Sweets 1981 Catalog, p. 7, McGraw Hill, Bus Stop Shelters.

Primary Examiner—A. Hugo Word
Assistant Examiner—Doris V. Coles
Attorney, Agent, or Firm—Lucas & Just

[57] CLAIM

The ornamental design for a bus stop marquee, as shown and described.

DESCRIPTION

FIG. 1 is a perspective view of a bus stop marquee, showing my new design;
FIG. 2 is a side elevational view of the embodiment of FIG. 1, the opposite side being a mirror image thereof;
FIG. 3 is a front elevational view of the embodiment of FIG. 1, the rear being a mirror image thereof;
FIG. 4 is a perspective view of a second embodiment;
FIG. 5 is a side elevational view of the embodiment of FIG. 4, the opposite side being a mirror image thereof; and,
FIG. 6 is a front elevational view of the embodiment of FIG. 4, the rear being a mirror image thereof.

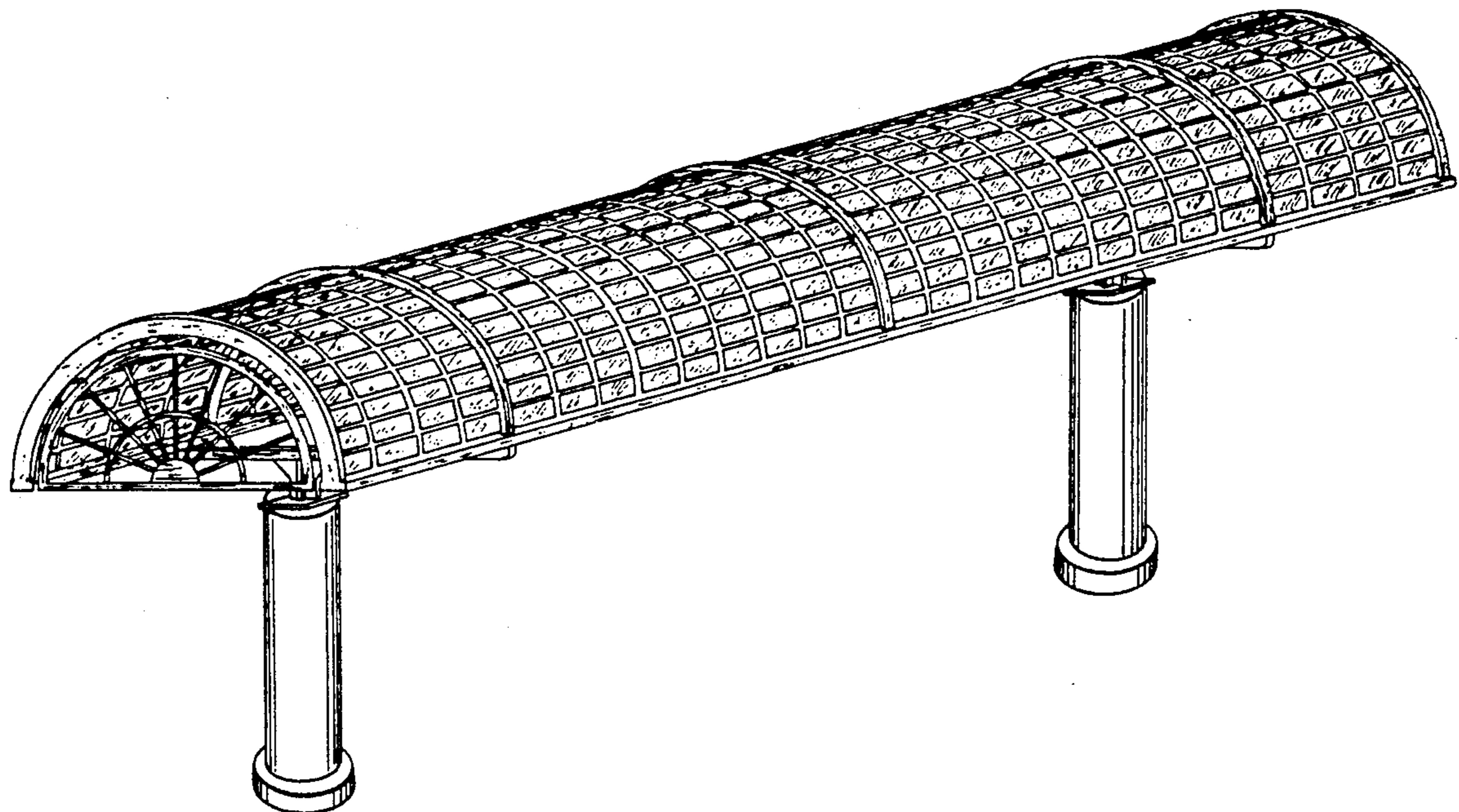

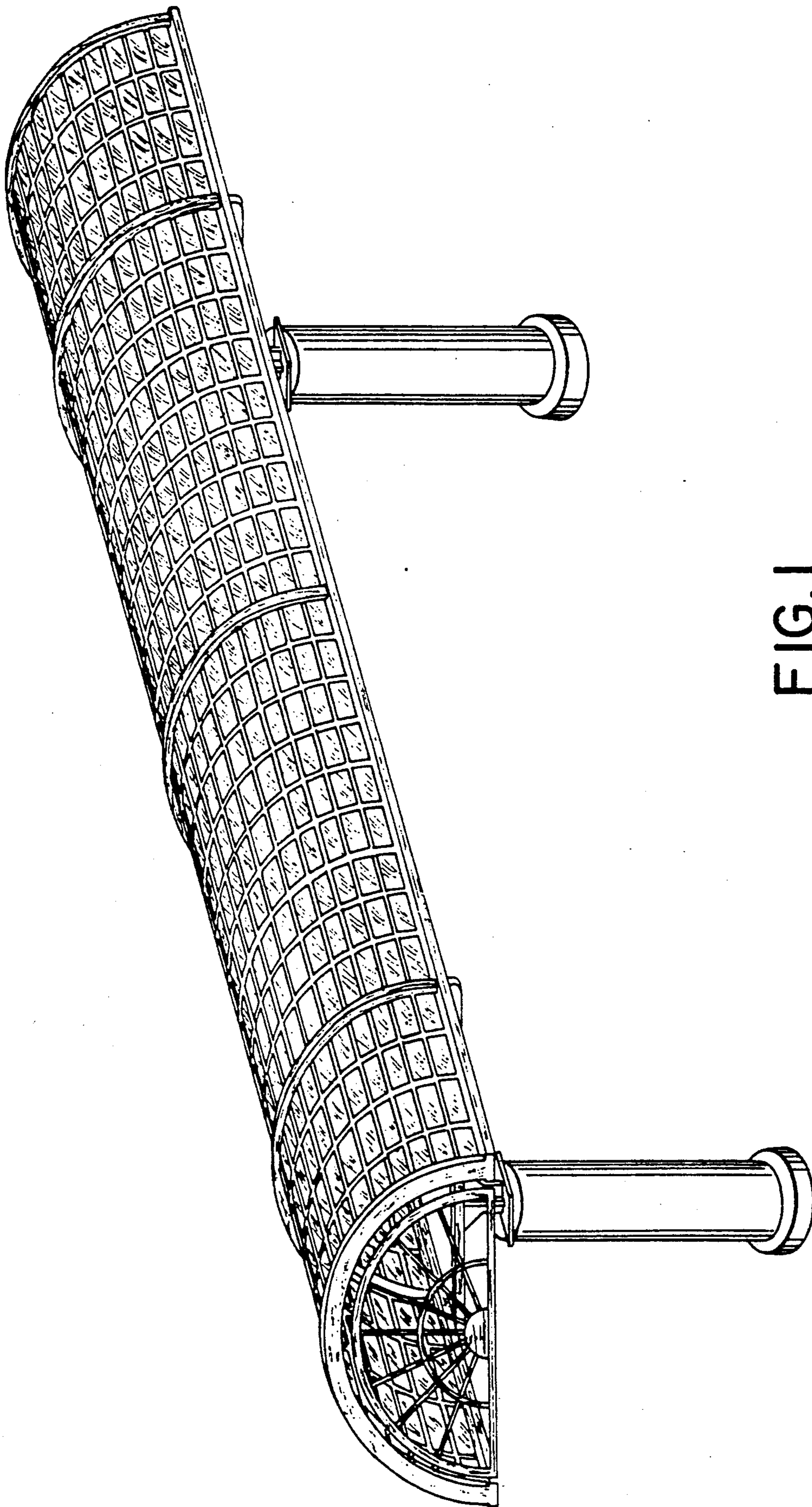

FIG. 1

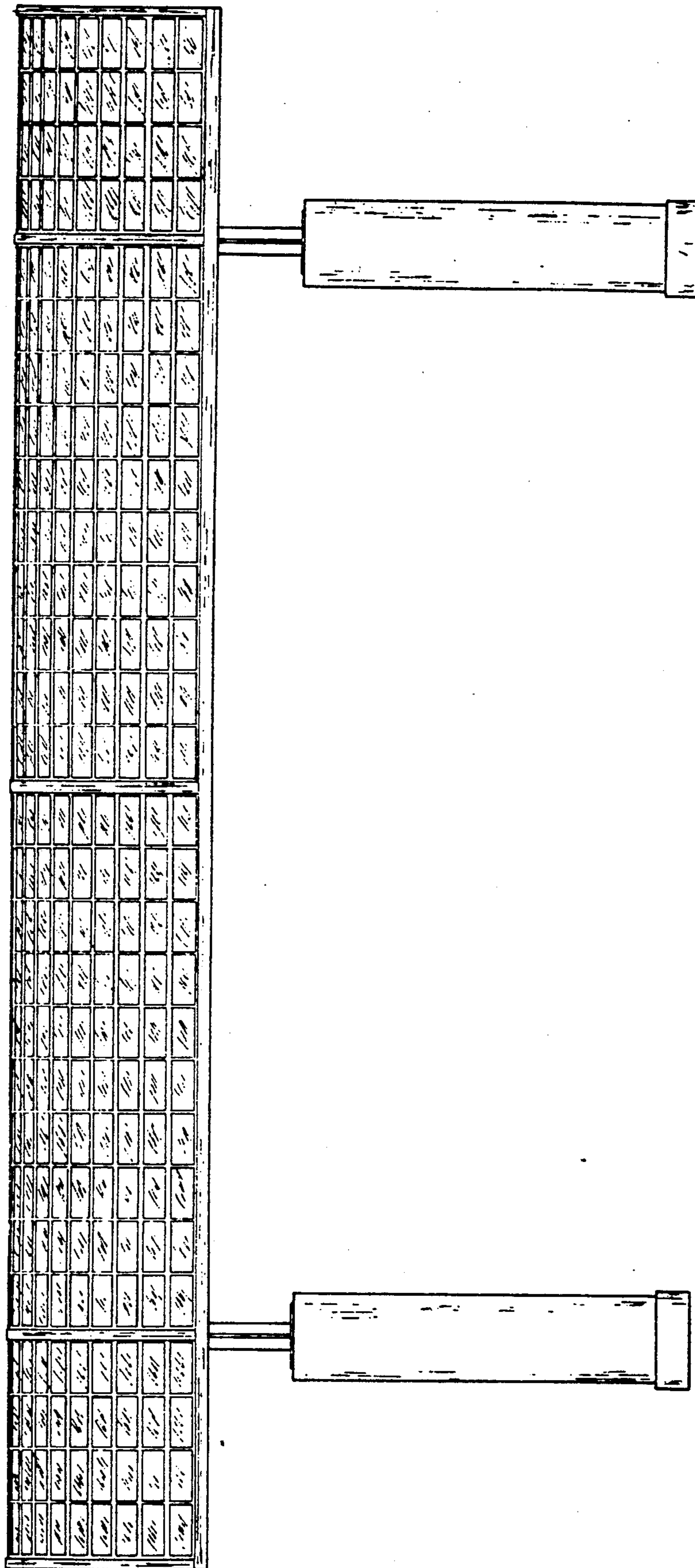

FIG. 2

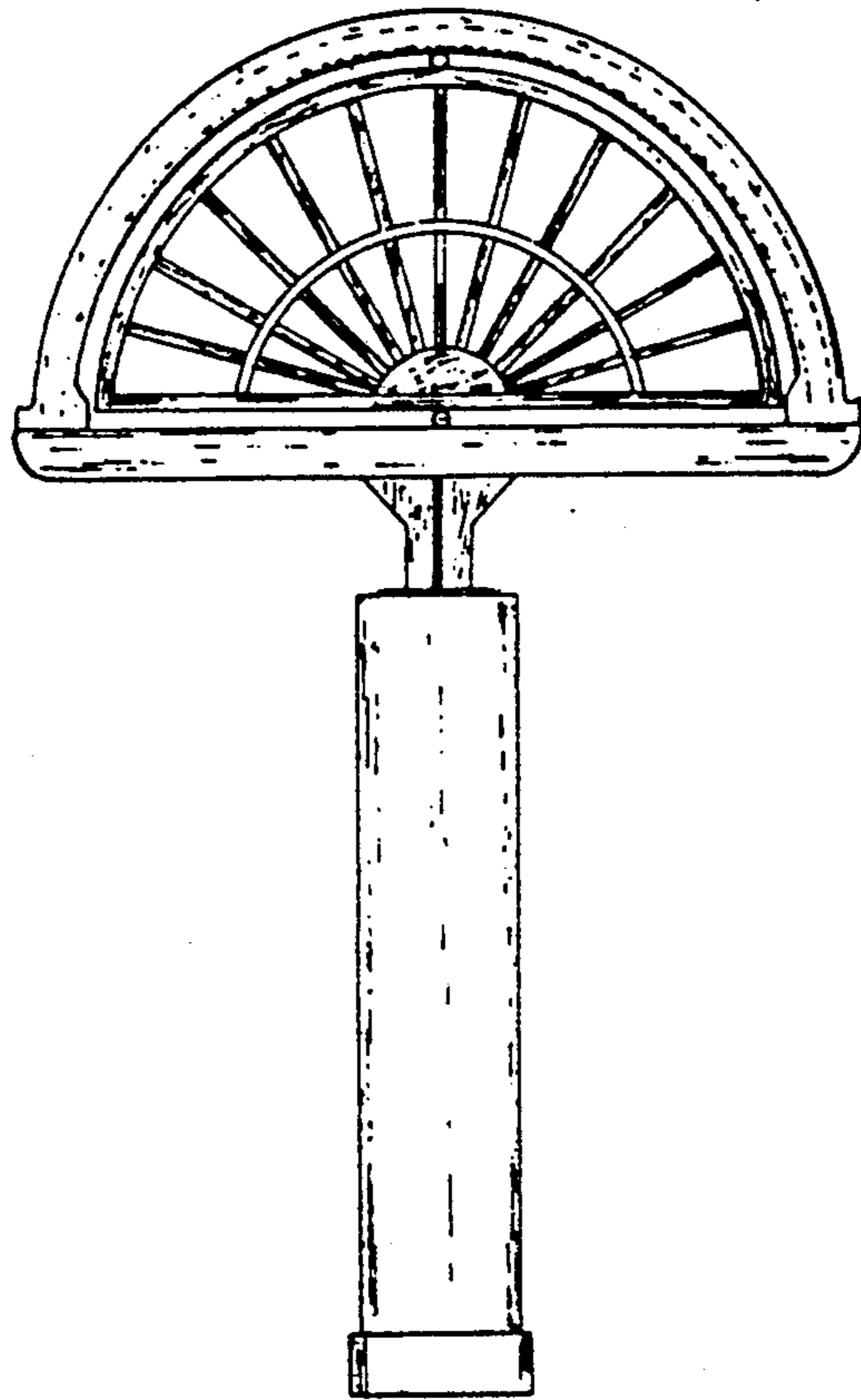

FIG. 3

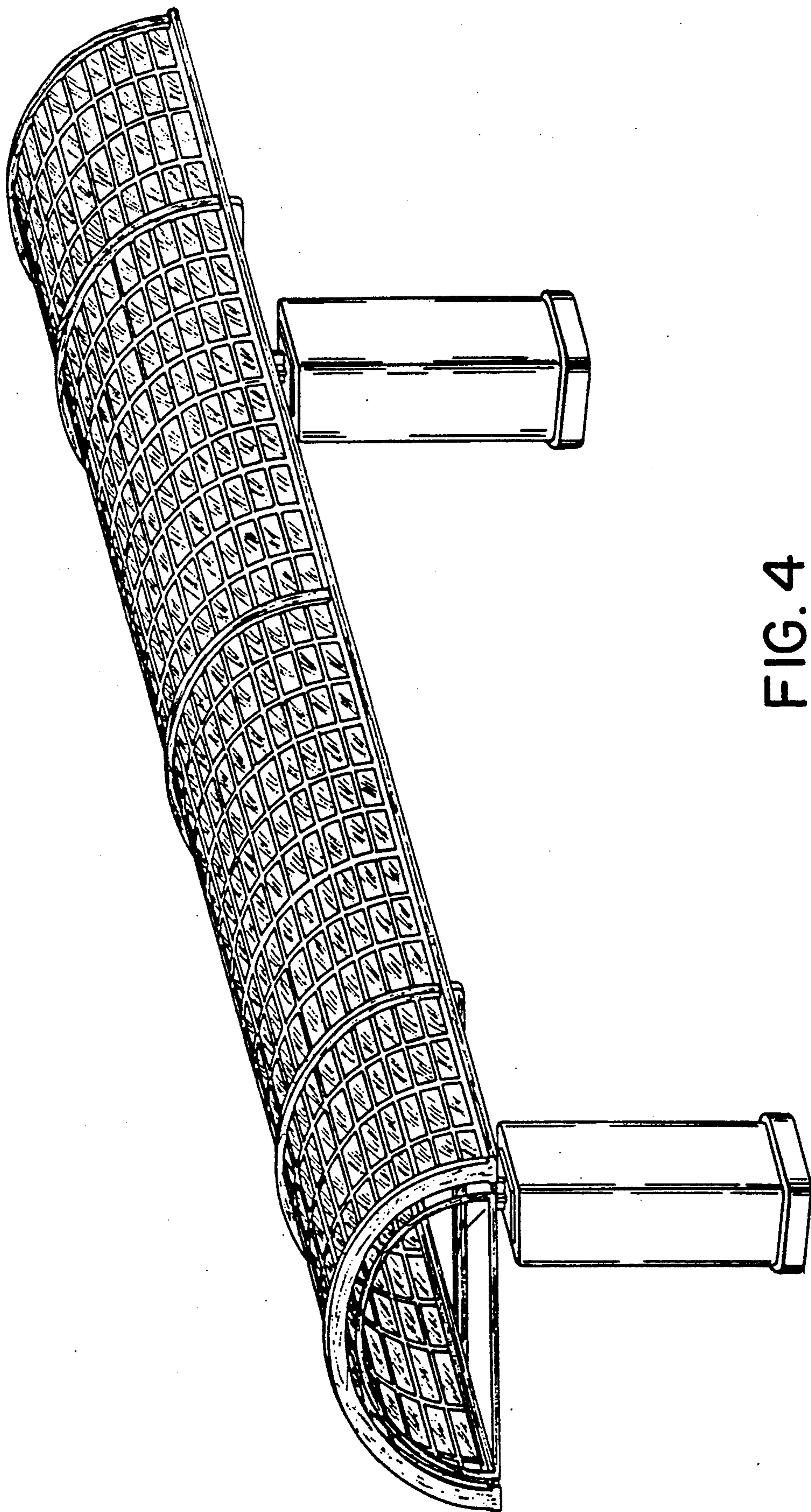

FIG. 4

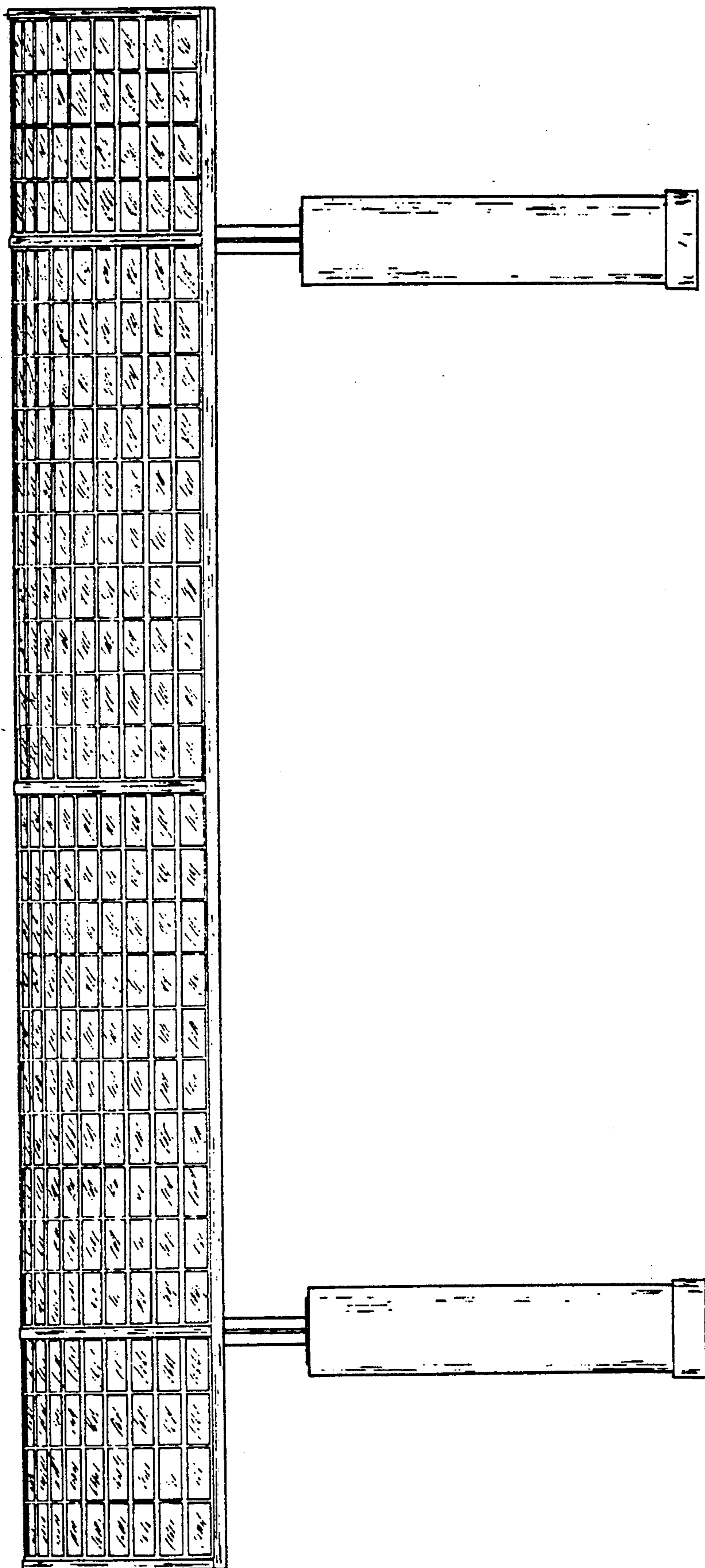

FIG. 5

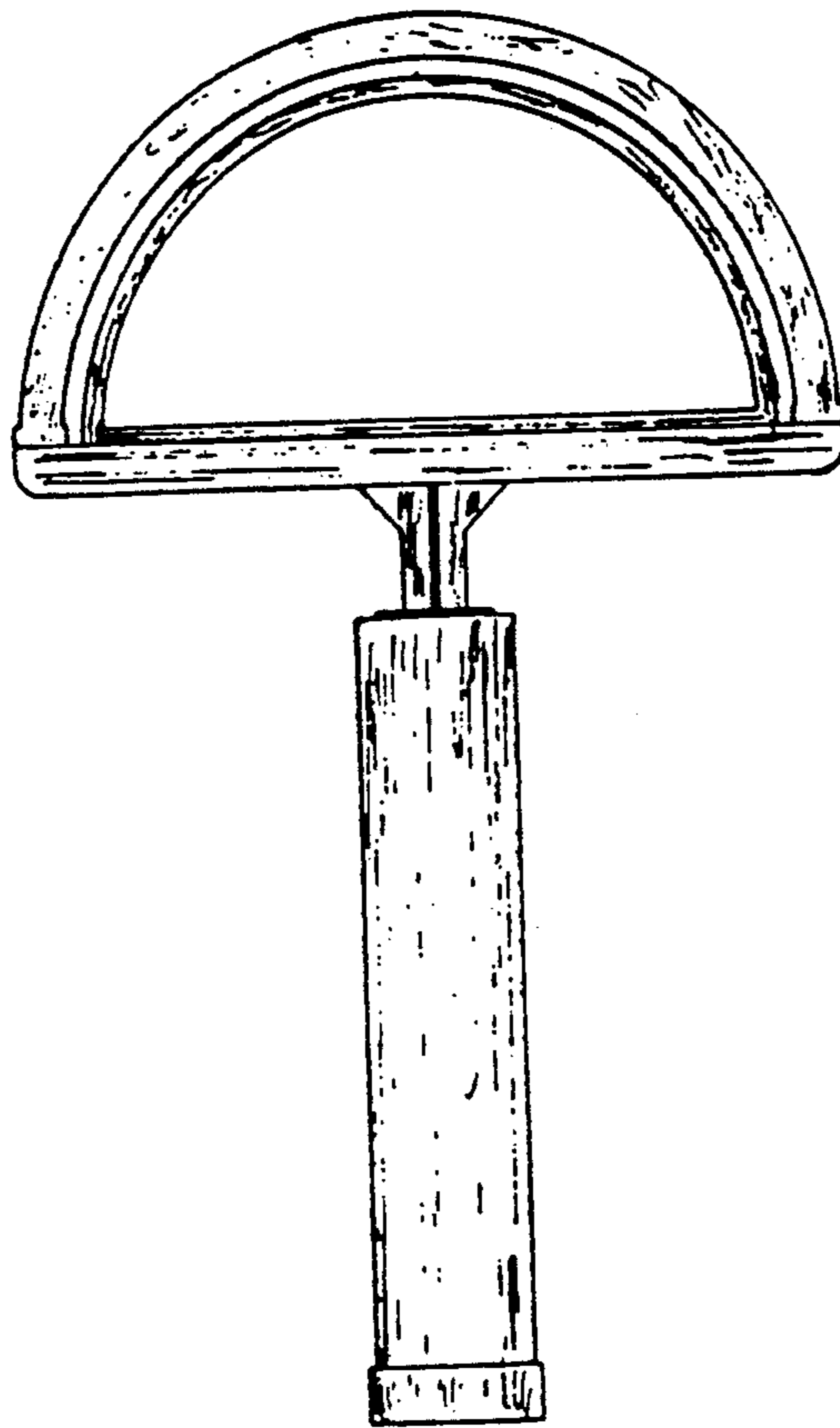

FIG. 6