



US00D339869S

# United States Patent [19]

[11] Patent Number: **Des. 339,869**

Schea, III et al.

[45] Date of Patent: **\*\* Sep. 28, 1993**

## [54] VIAL CONTAINER

[75] Inventors: **Henry E. Schea, III, Oxnard; Gregory D. Crowe, Glendale; John C. Rodden, Long Beach, all of Calif.**

[73] Assignee: **Amgen, Inc., Thousand Oaks, Calif.**

[\*\*] Term: **14 Years**

[21] Appl. No.: **641,091**

[22] Filed: **Jan. 14, 1991**

[52] U.S. Cl. .... **D24/224; D24/227; D24/229; D24/230**

[58] Field of Search ..... **D24/122, 226, 229, 230; 422/102, 104, 99**

## [56] References Cited

### U.S. PATENT DOCUMENTS

D. 240,239	6/1976	Calandrino	.....	D24/230
3,388,807	6/1968	Emmitt	.....	D24/230 X
4,411,868	10/1983	Noack	.....	422/102
4,982,850	1/1991	Mears	.....	D24/128 X

*Primary Examiner*—A. Hugo Word

*Assistant Examiner*—I. Simmons

*Attorney, Agent, or Firm*—Marshall, O'Toole, Gerstein, Murray & Borun

## [57] CLAIM

The ornamental design for a vial container, as shown and described.

## DESCRIPTION

FIG. 1 is a perspective view showing the back, side and top of a vial container, showing our new design;  
 FIG. 2 is a top plan view thereof;  
 FIG. 3 is a side elevational view thereof, the opposite side elevational view being identical thereto;  
 FIG. 4 is a rear elevational view thereof, the front elevational view being identical thereto;  
 FIG. 5 is a bottom plan view thereof;  
 FIG. 6 is a top plan view of a second embodiment of FIG. 1;  
 FIG. 7 is a top plan view of a third embodiment of FIG. 1;  
 FIG. 8 is a perspective view showing the back, side, and top of the second embodiment of FIG. 1;  
 FIG. 9 is a bottom plan view of the second embodiment of FIG. 1;  
 FIG. 10 is a rear elevational view of the second embodiment of FIG. 1, the front elevational view being identical thereto;  
 FIG. 11 is a side elevational view of the second embodiment of FIG. 1, the opposite side elevational view being identical thereto;  
 FIG. 12 is a perspective view showing the back, side, and top of the third embodiment of FIG. 1;  
 FIG. 13 is a bottom plan view of the third embodiment of FIG. 1;  
 FIG. 14 is a rear elevational view of the third embodiment of FIG. 1, the front elevational view being identical thereto; and,  
 FIG. 15 is a side elevational view of the third embodiment of FIG. 1, the opposite side elevational view being identical thereto.

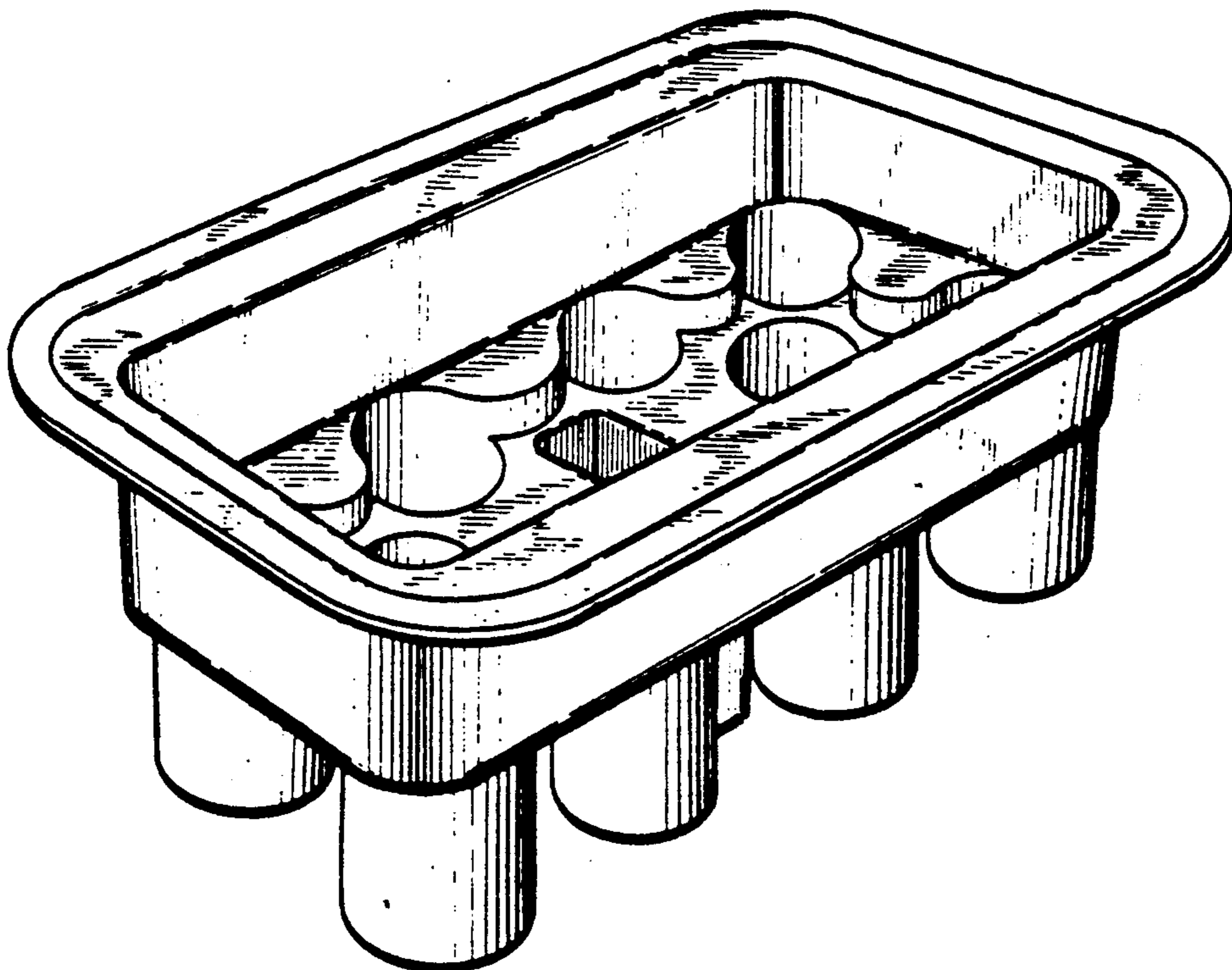

FIG. 1

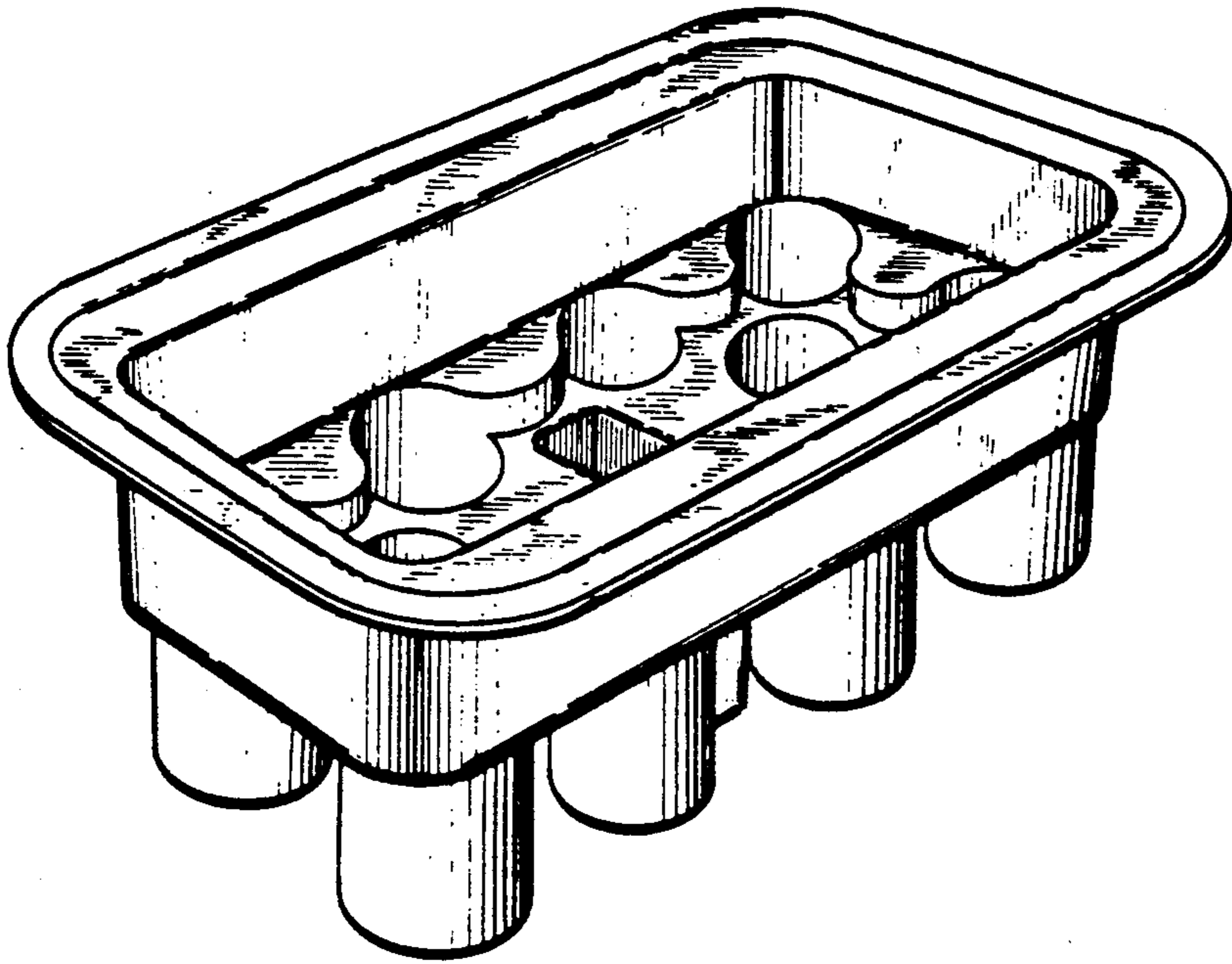

FIG. 2

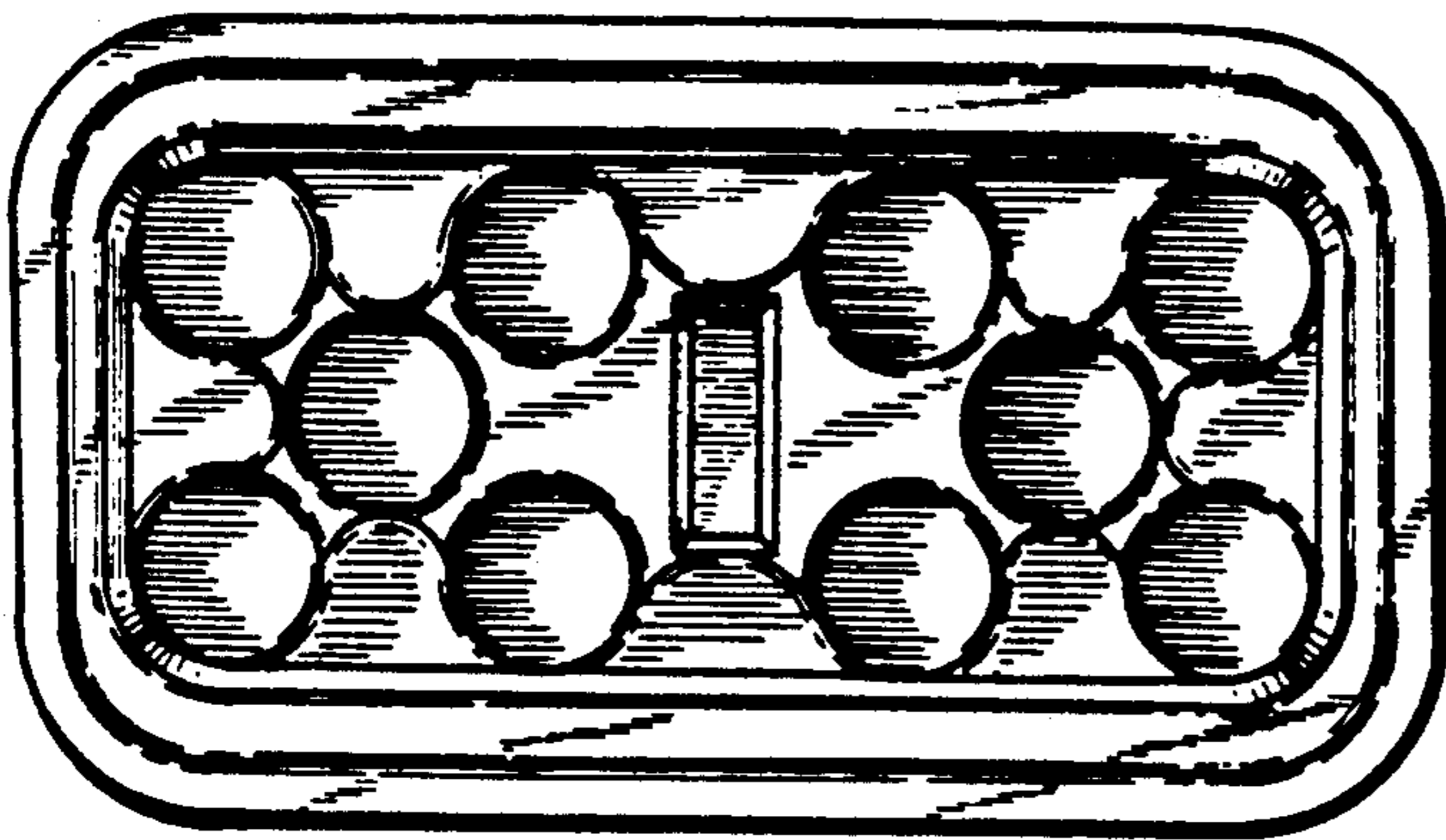

FIG. 3

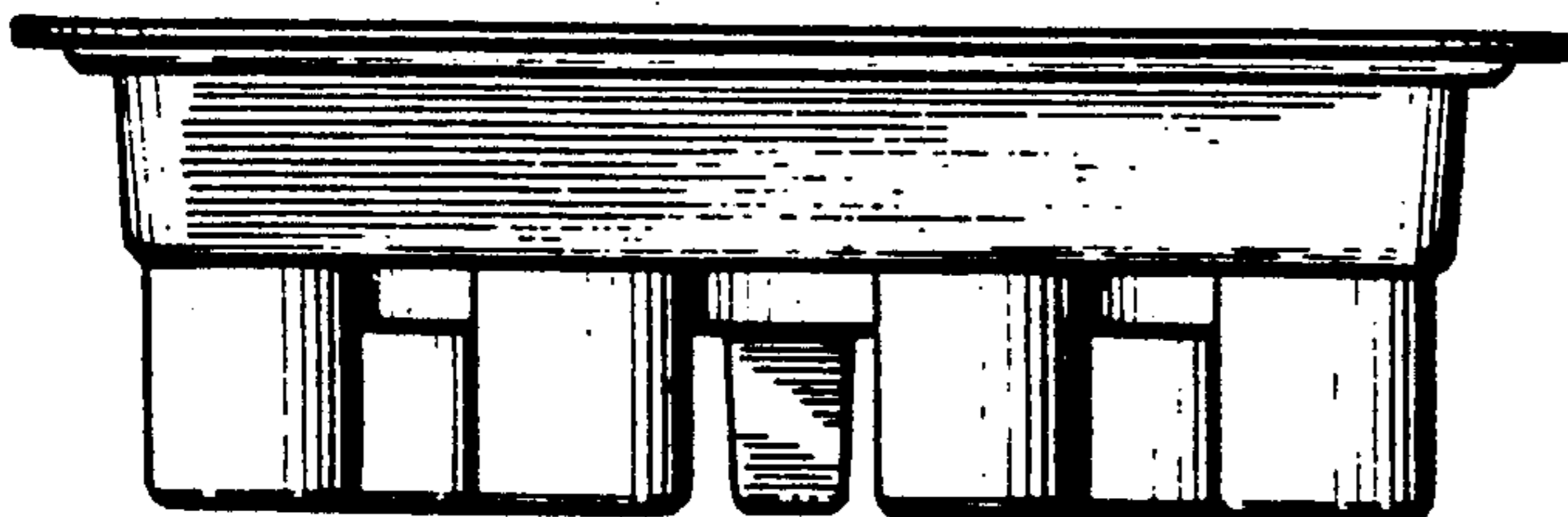

FIG. 4

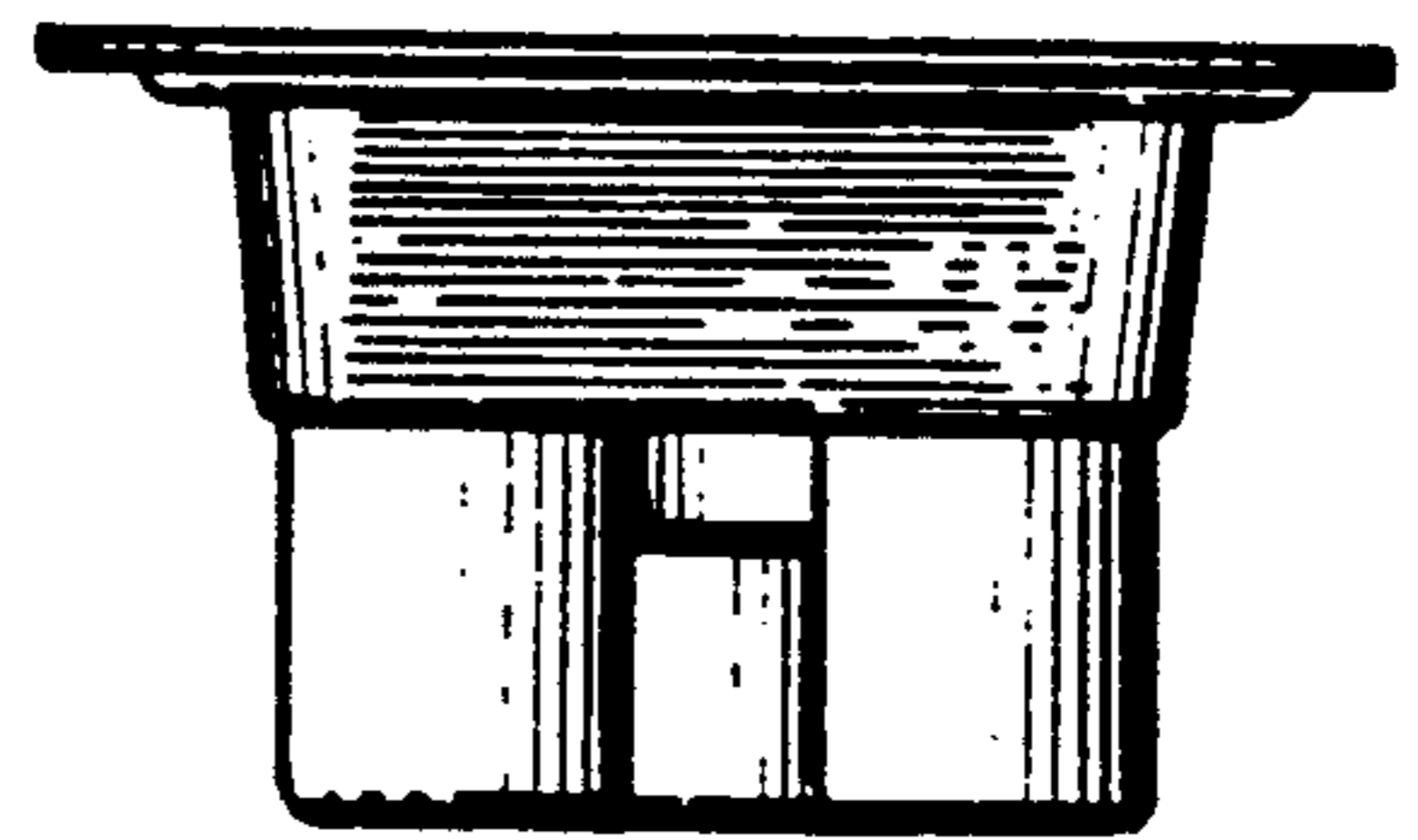



FIG. 5

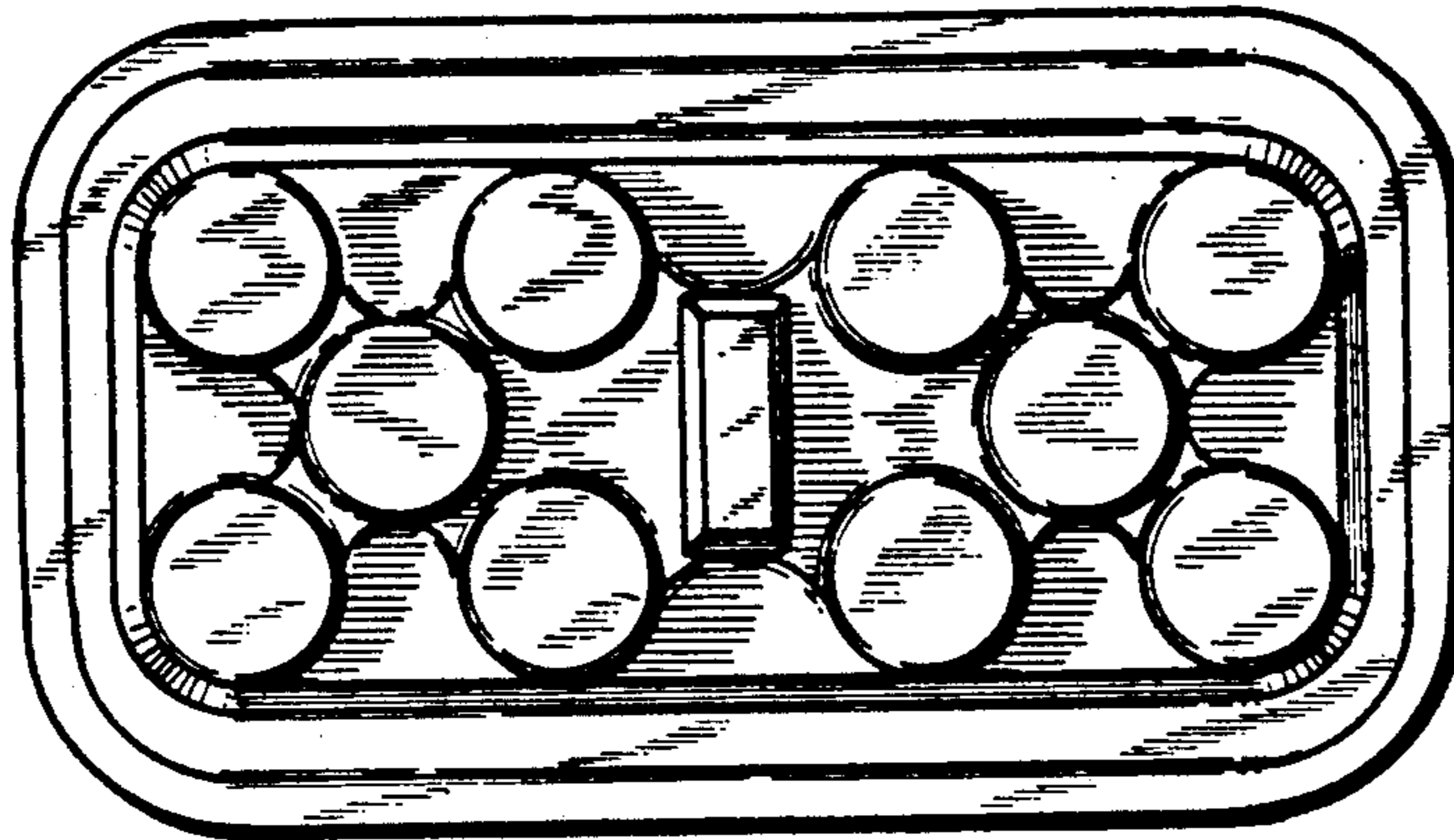

FIG. 6

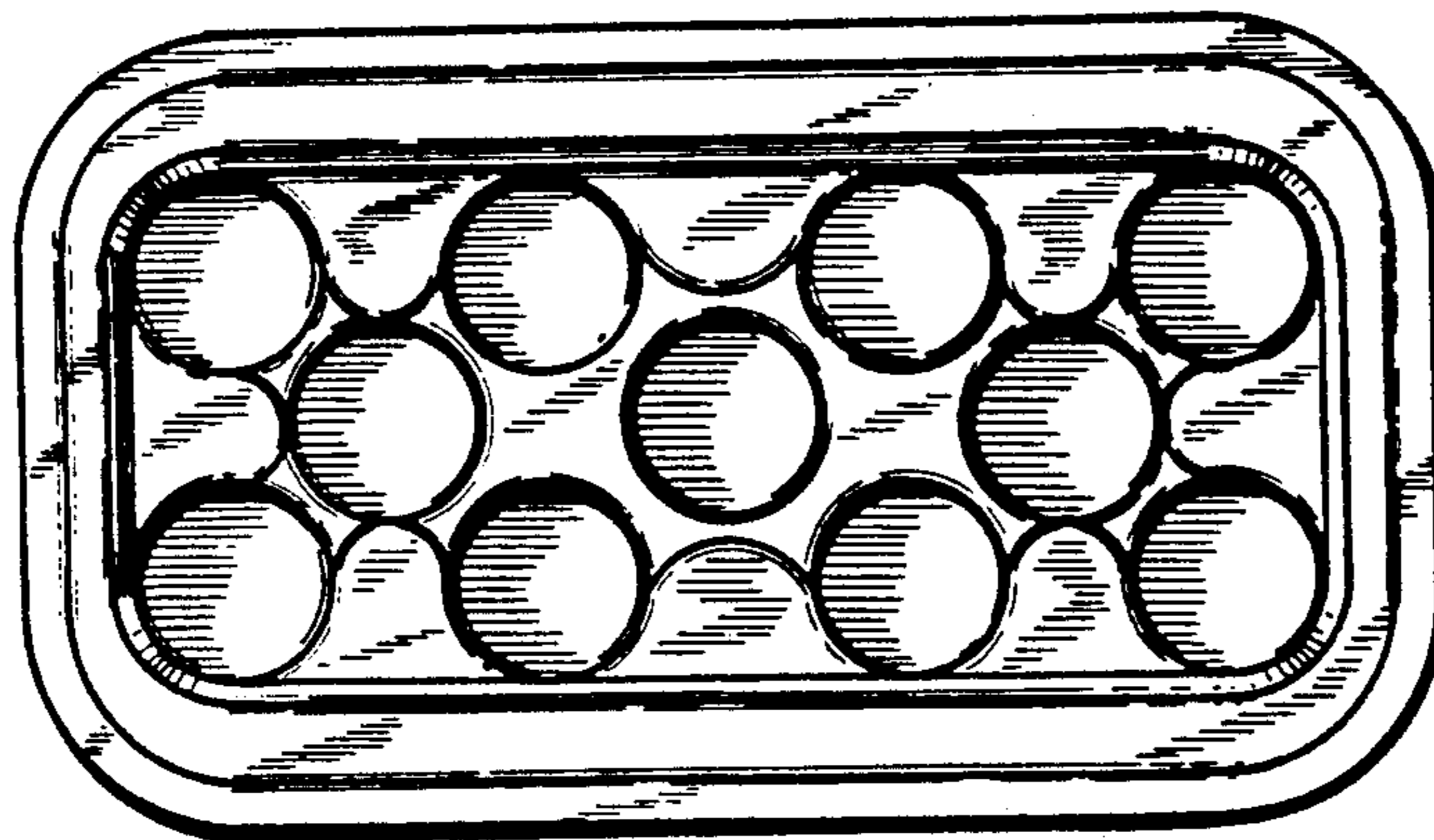

FIG. 7

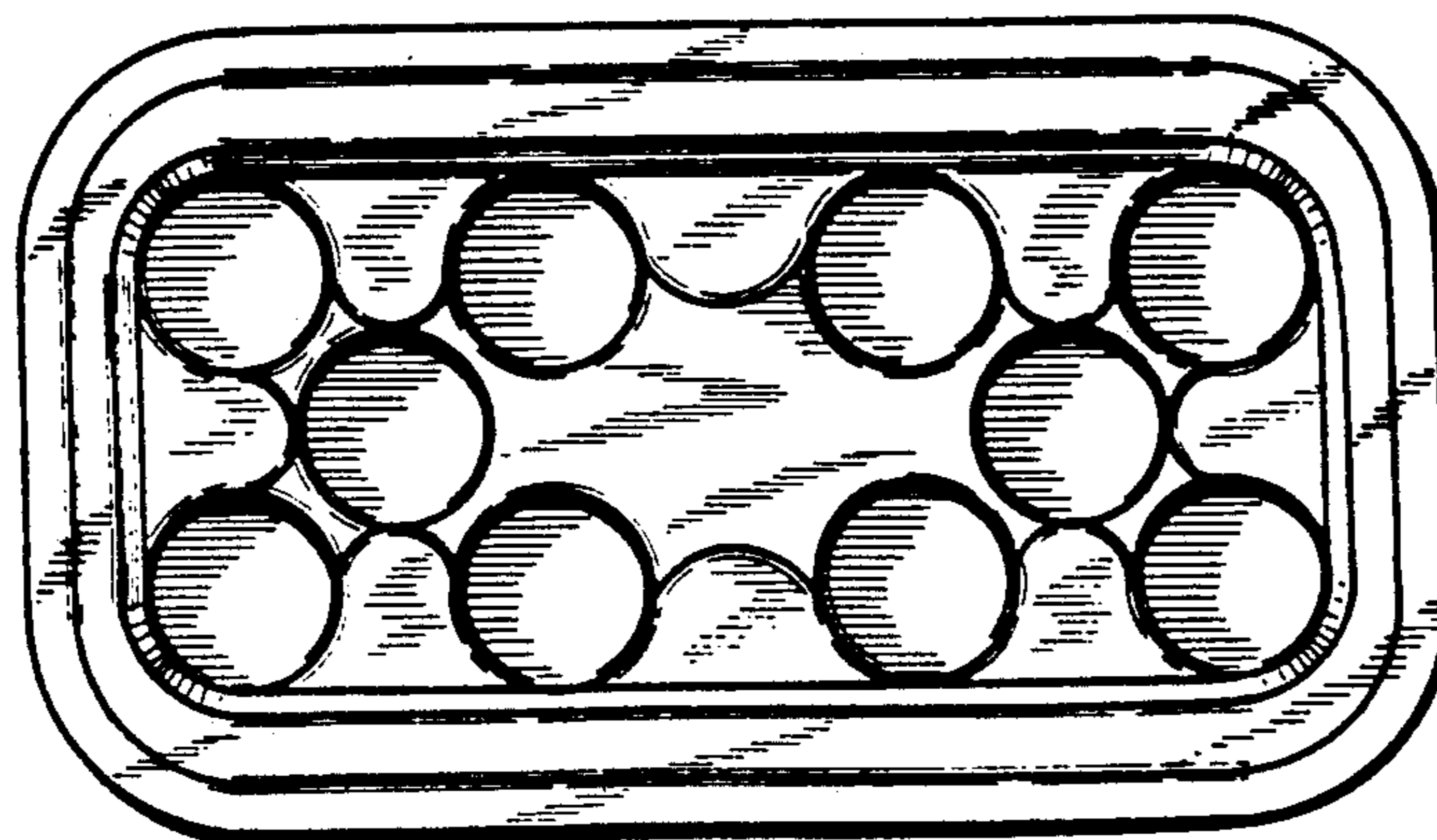

FIG. 8

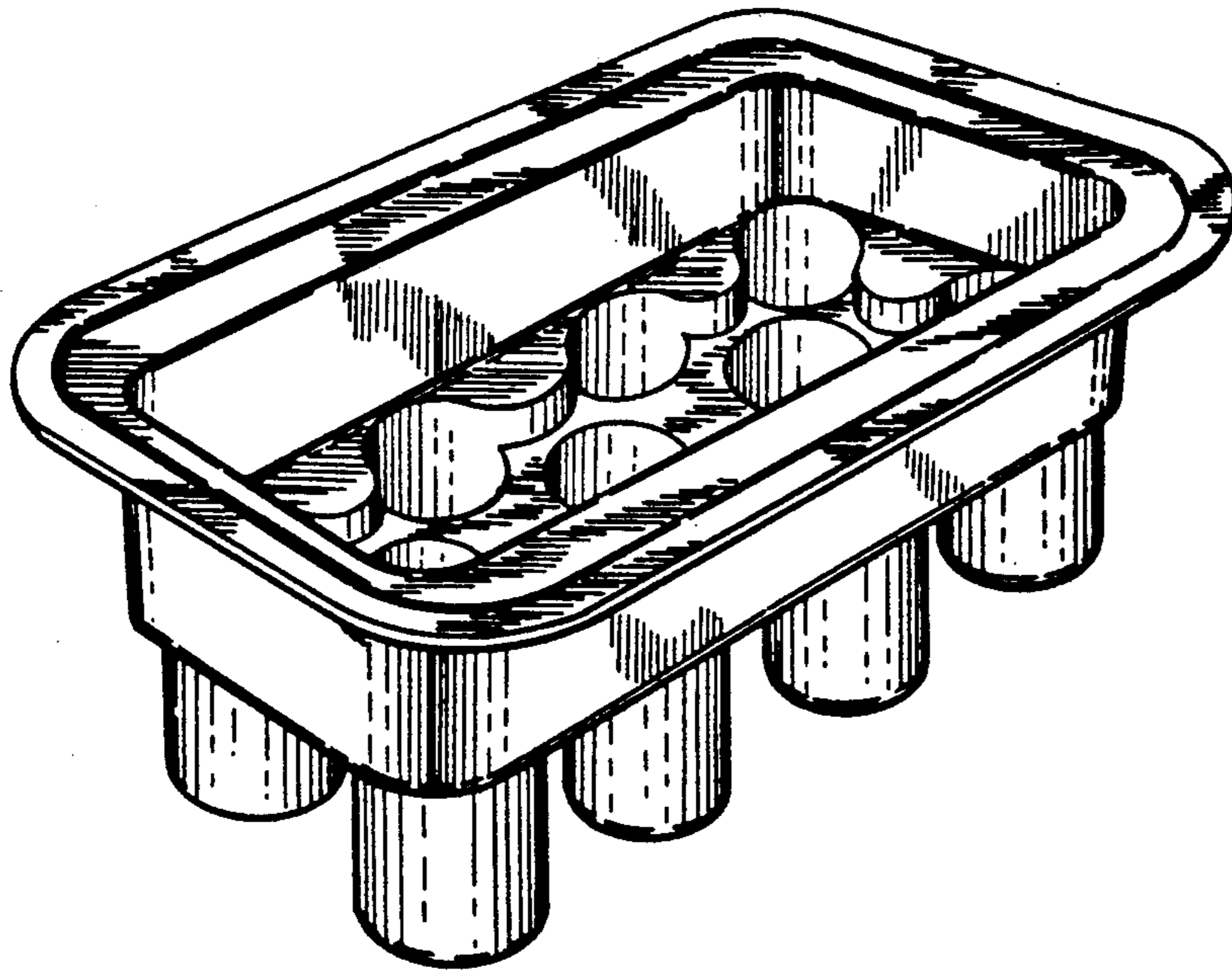

FIG. 9

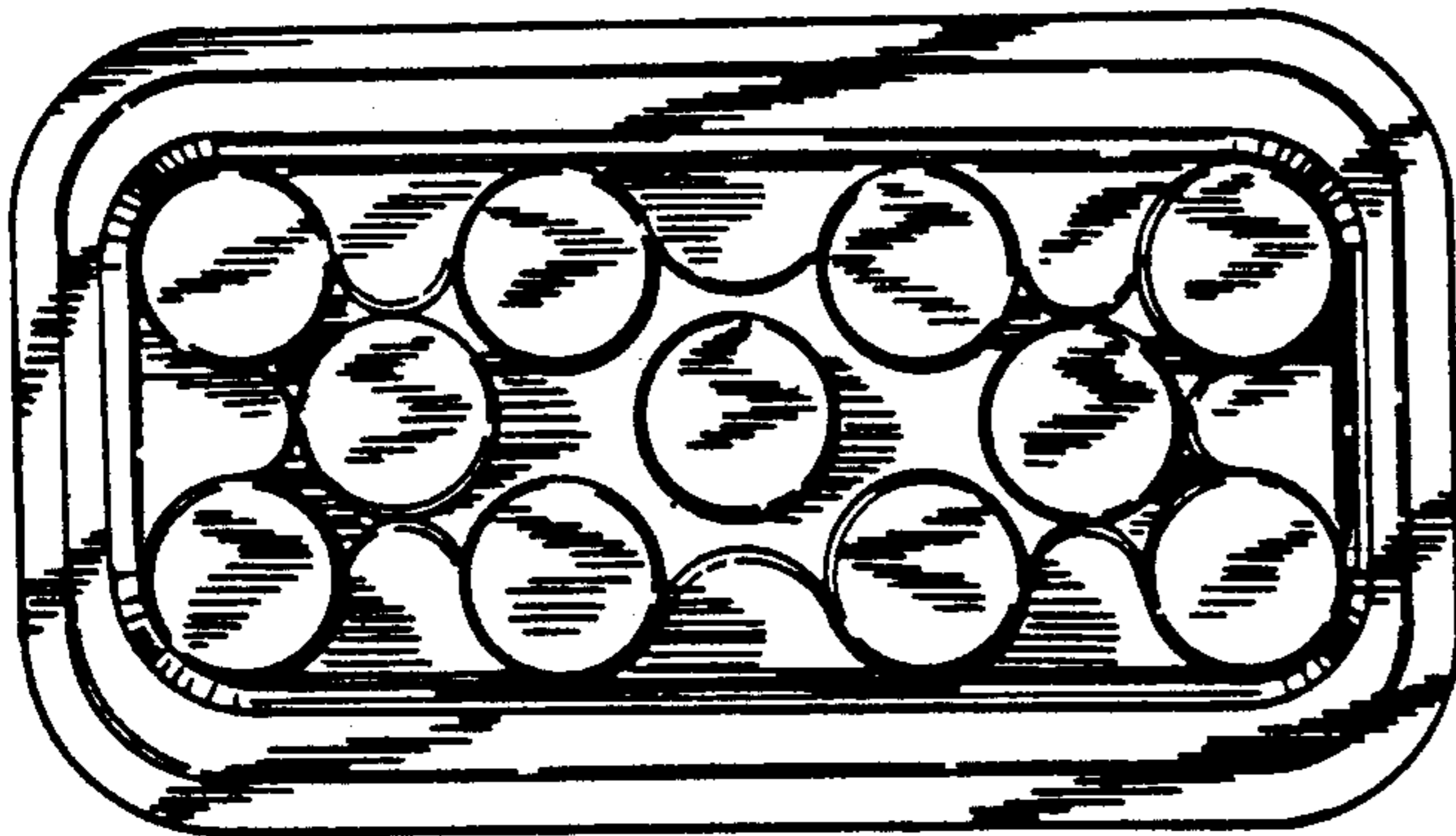

FIG. 10

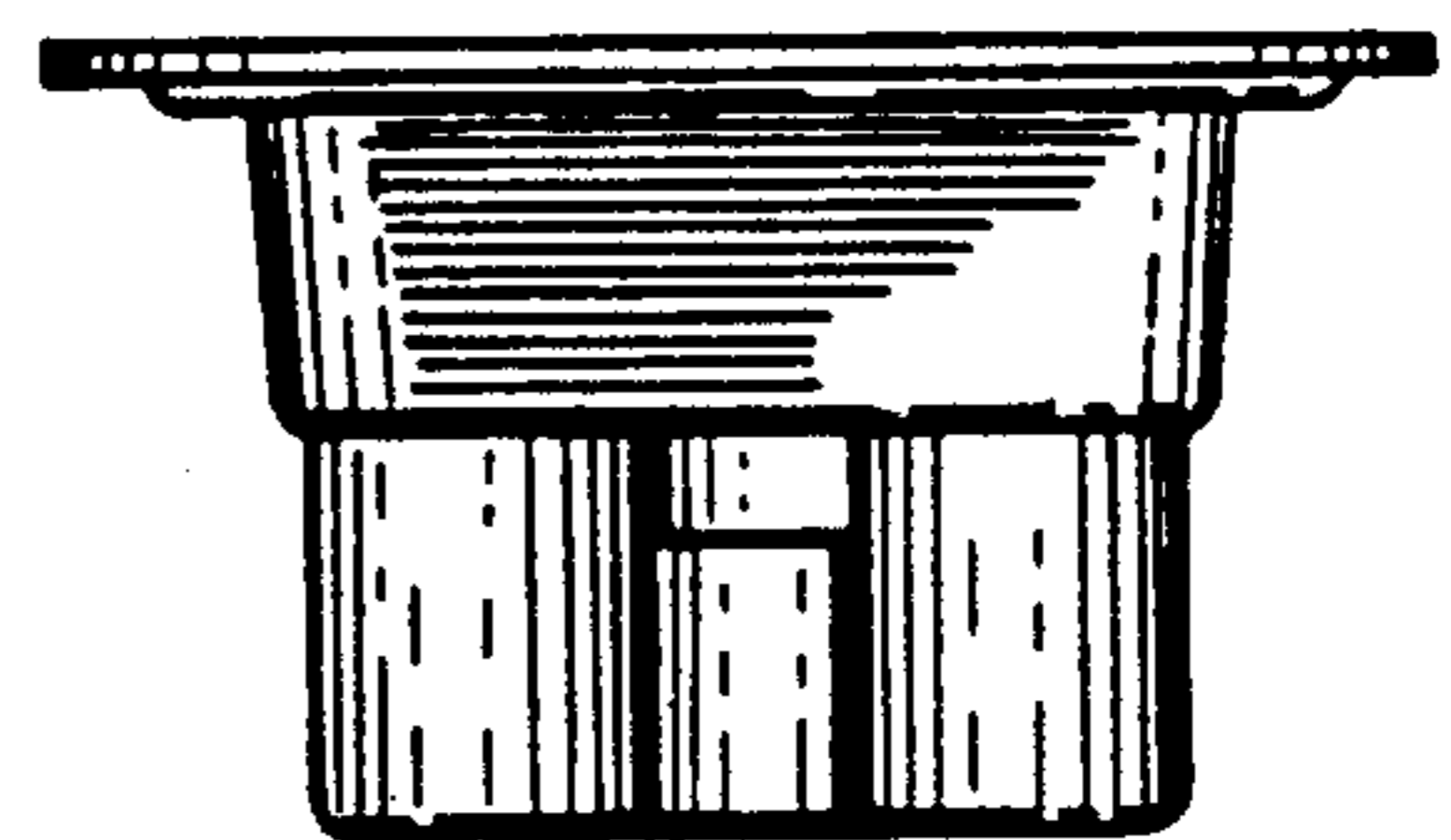

FIG. 11

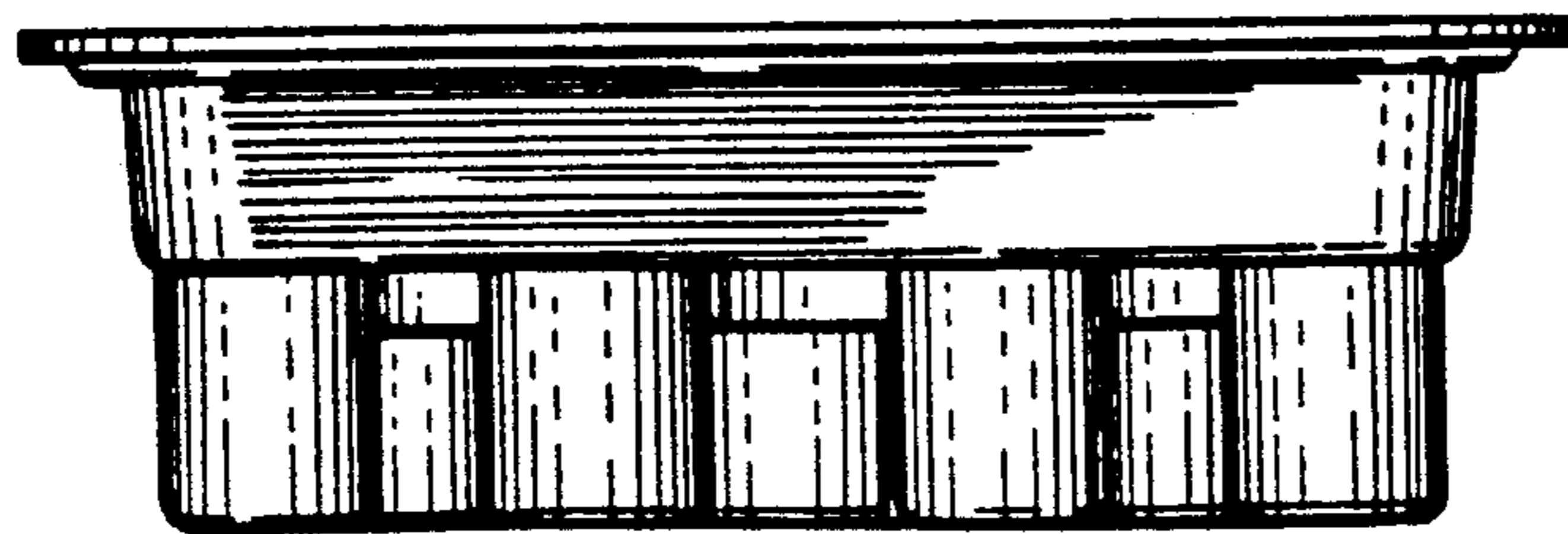

FIG.12

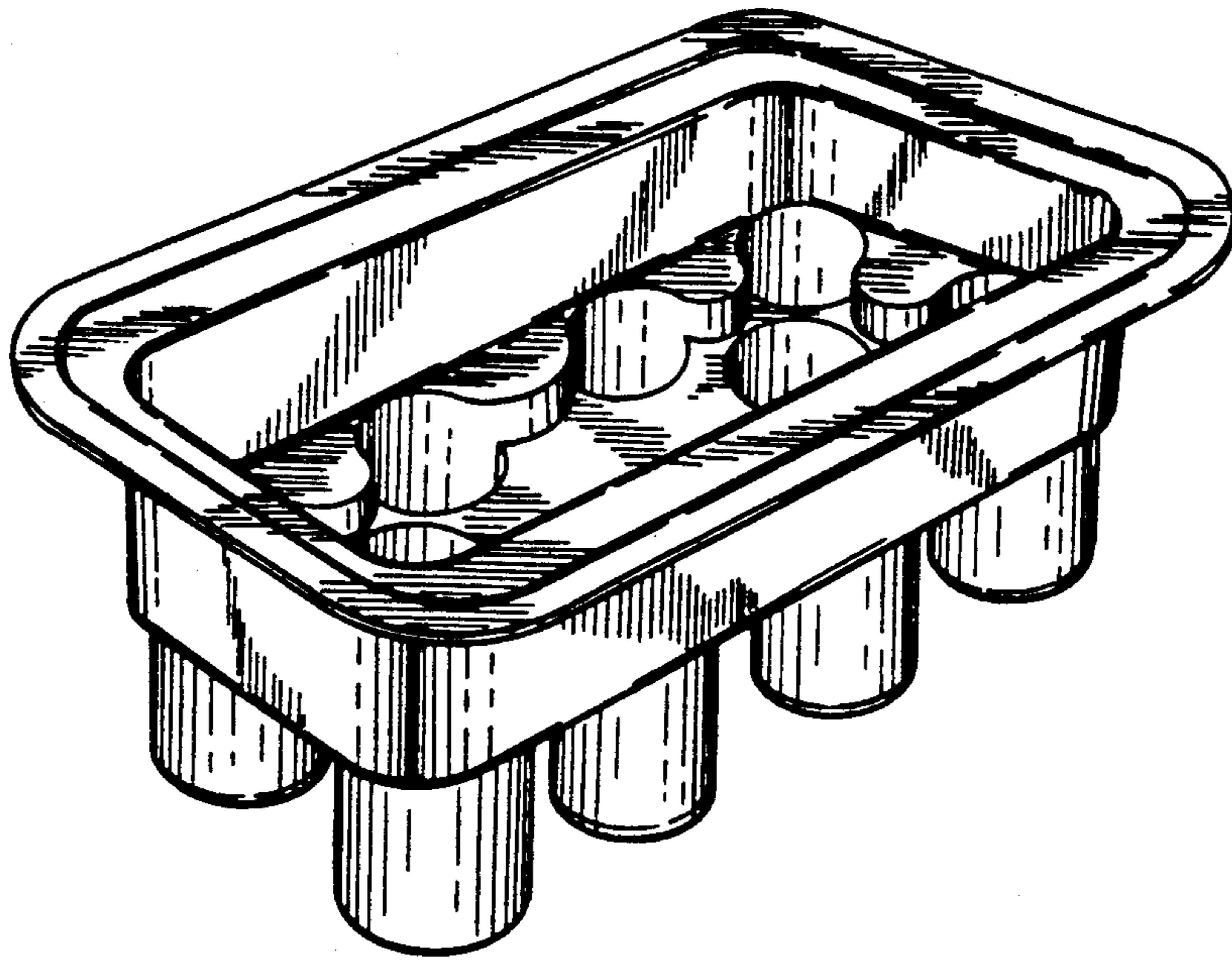

FIG.13

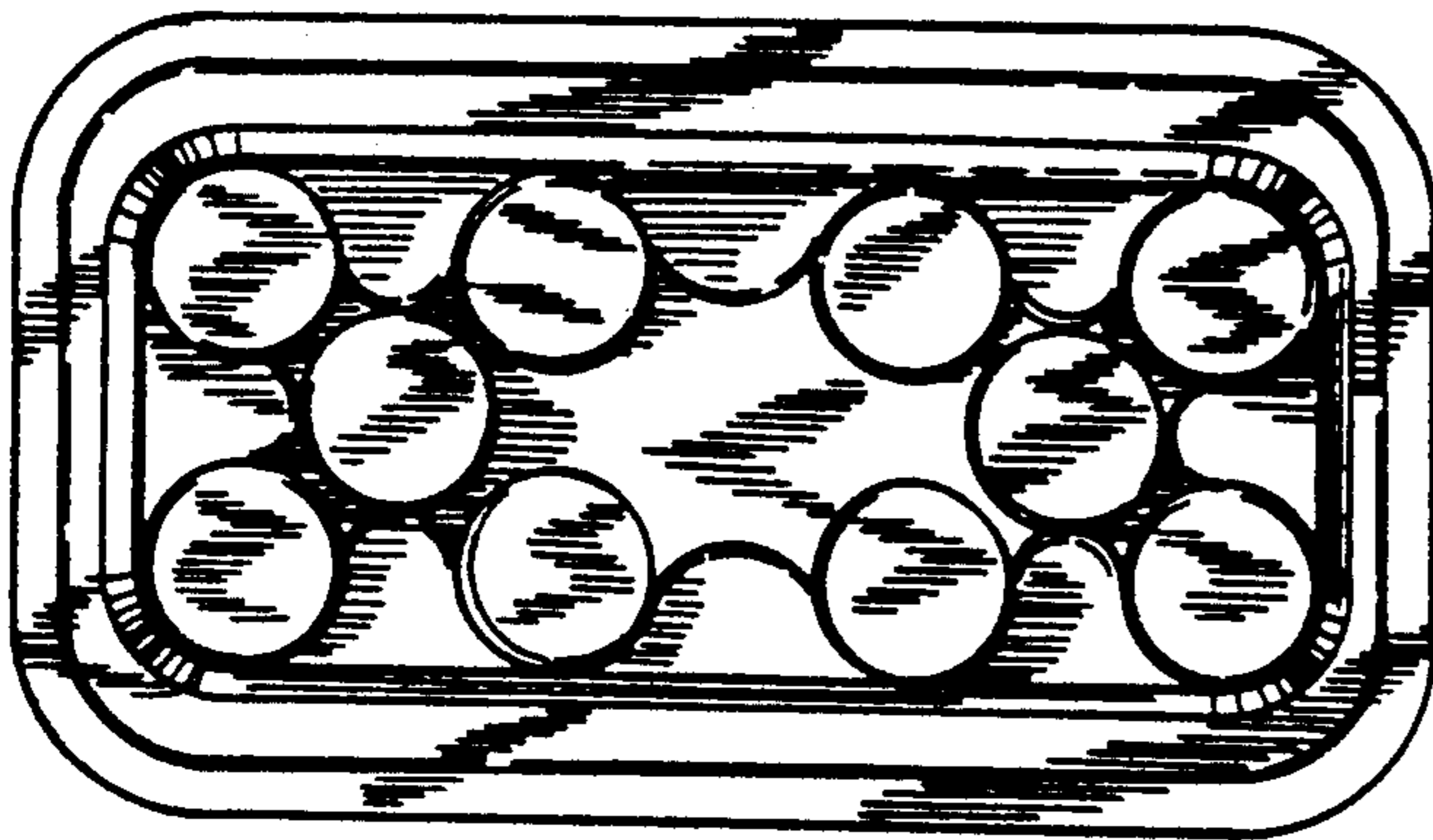

FIG.14

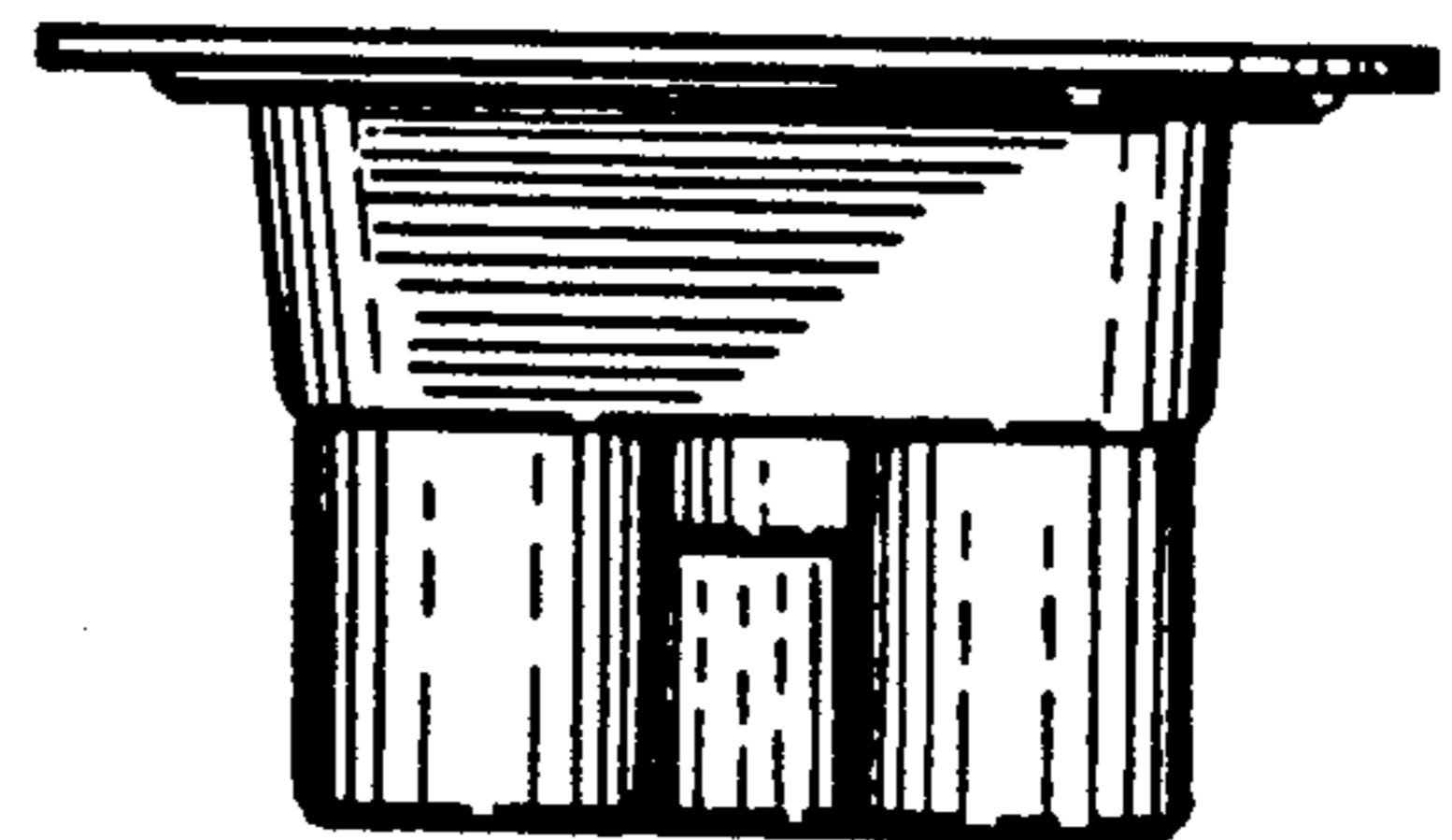

FIG.15

