



US00D339842S

United States Patent [19]

[11] Patent Number: **Des. 339,842**

Spiczka

[45] Date of Patent: **** Sep. 28, 1993**

[54] **ICE FISHING SLED**

[76] Inventor: **Harry D. Spiczka, Box 231A RR#2, Kimball, Minn. 55353**

[**] Term: **14 Years**

[21] Appl. No.: **669,275**

[22] Filed: **Mar. 14, 1991**

[52] U.S. Cl. **D22/134**

[58] Field of Search **D22/134, 149, 199; D12/6, 9, 10; 43/55, 21.2, 54.1**

3,357,127	12/1967	Barradale	43/55
4,297,804	11/1981	Weld	43/55
4,456,272	6/1984	Kroeger	D25/16 X
4,996,790	3/1991	Ruggles	43/55

*Primary Examiner—A. Hugo Word
Assistant Examiner—Doris V. Coles
Attorney, Agent, or Firm—Leon Gilden*

[57] **CLAIM**

The ornamental design for a nice fishing sled, as shown and described.

DESCRIPTION

FIG. 1 is a front elevational view of an ice fishing sled, showing my new design;
FIG. 2 is a rear elevational view thereof;
FIG. 3 is a left side elevational view thereof;
FIG. 4 is a right side elevational view thereof;
FIG. 5 is a top plan view thereof;
FIG. 6 is a bottom plan view thereof; and,
FIG. 7 is a perspective view of the invention showing a use thereof.

[56] **References Cited**

U.S. PATENT DOCUMENTS

D. 283,112	3/1986	McFrisby	D12/10
D. 309,937	8/1990	Baxter	D22/134
D. 313,061	12/1990	Bascom et al.	D22/134
1,630,131	5/1927	Messinger	D22/146
2,657,496	11/1953	Spotswood	43/55
3,045,262	7/1962	Mitchell	43/55
3,304,645	2/1967	Hardesty et al.	43/55

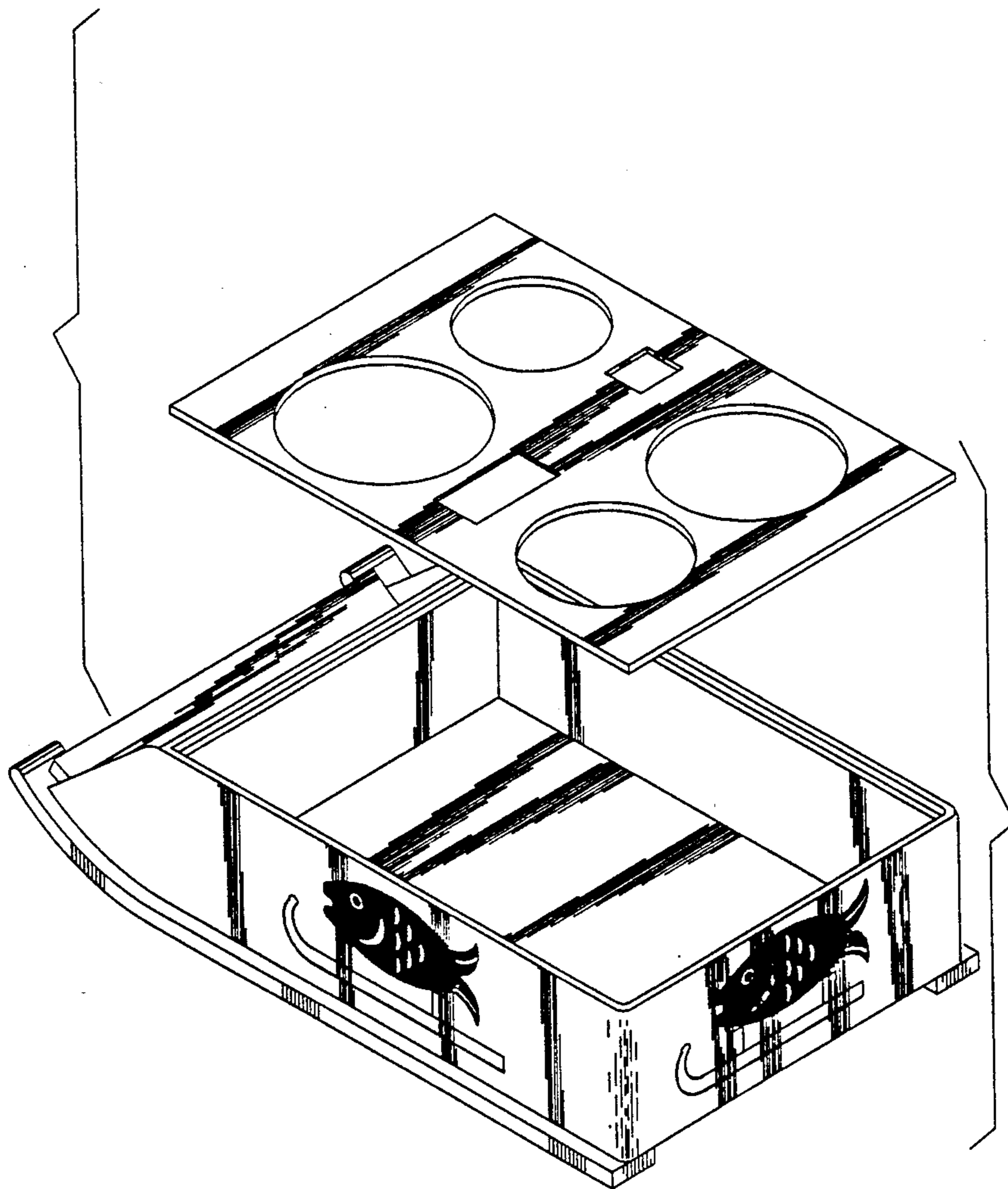

FIG. 1

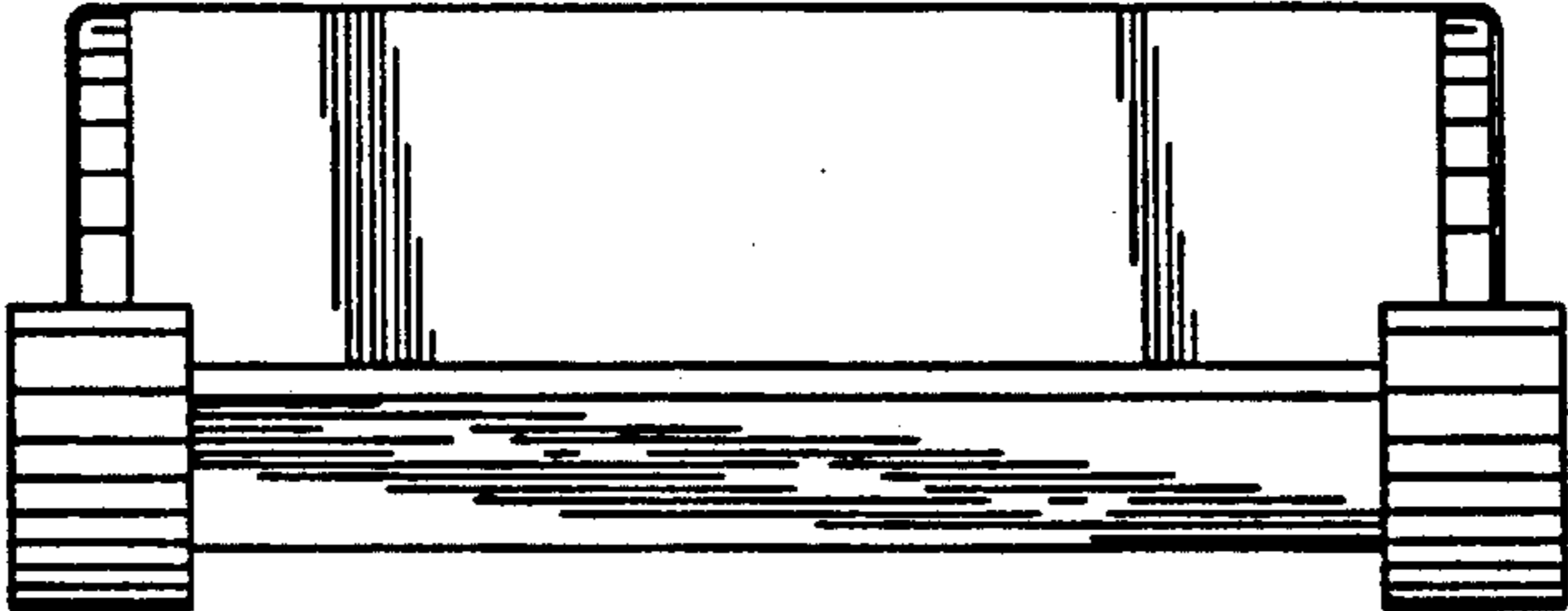

FIG. 2

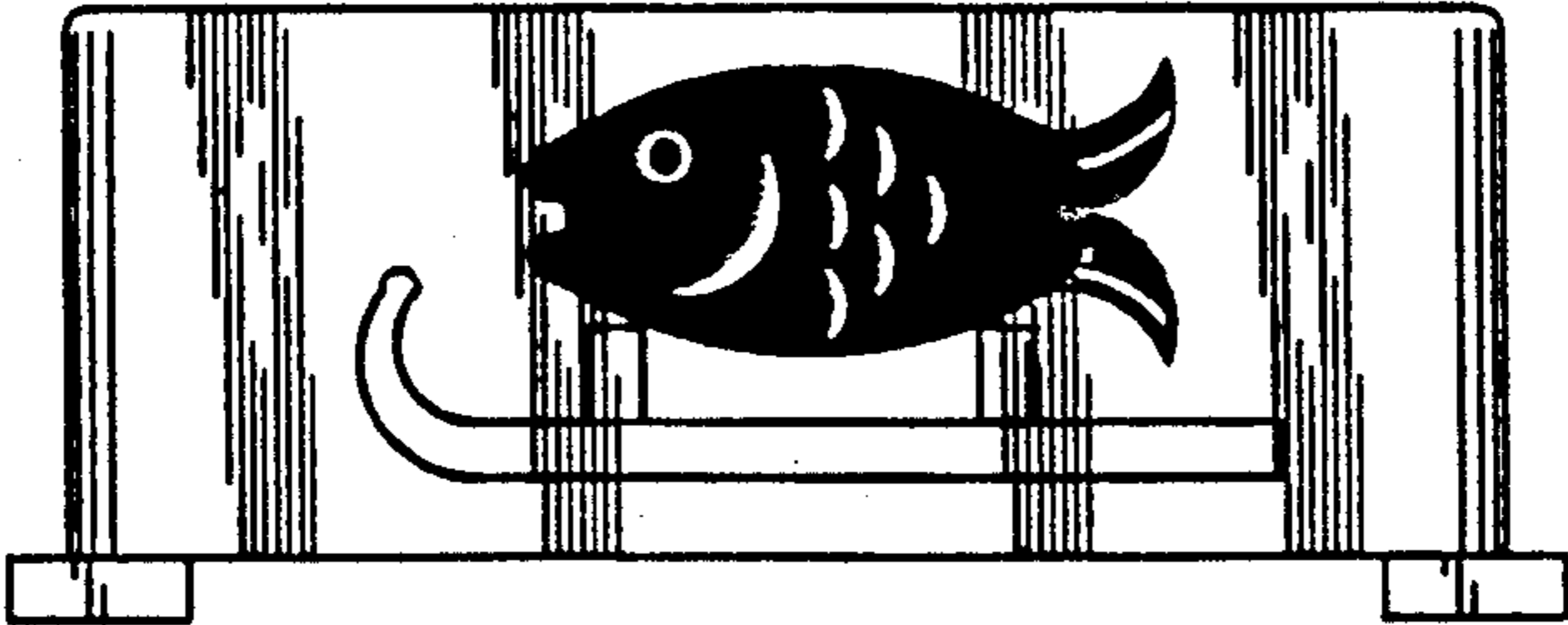

FIG. 3

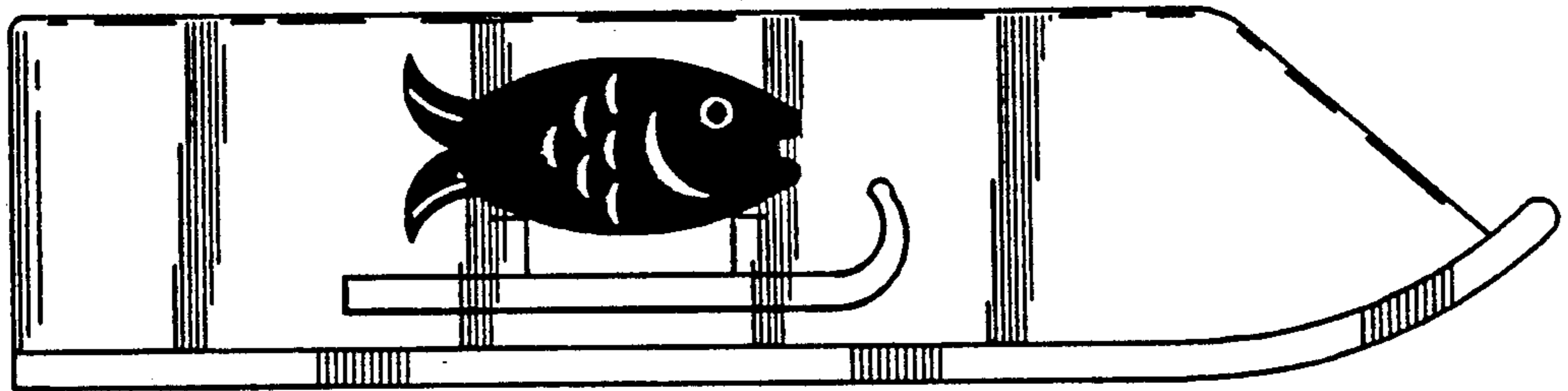

FIG. 4

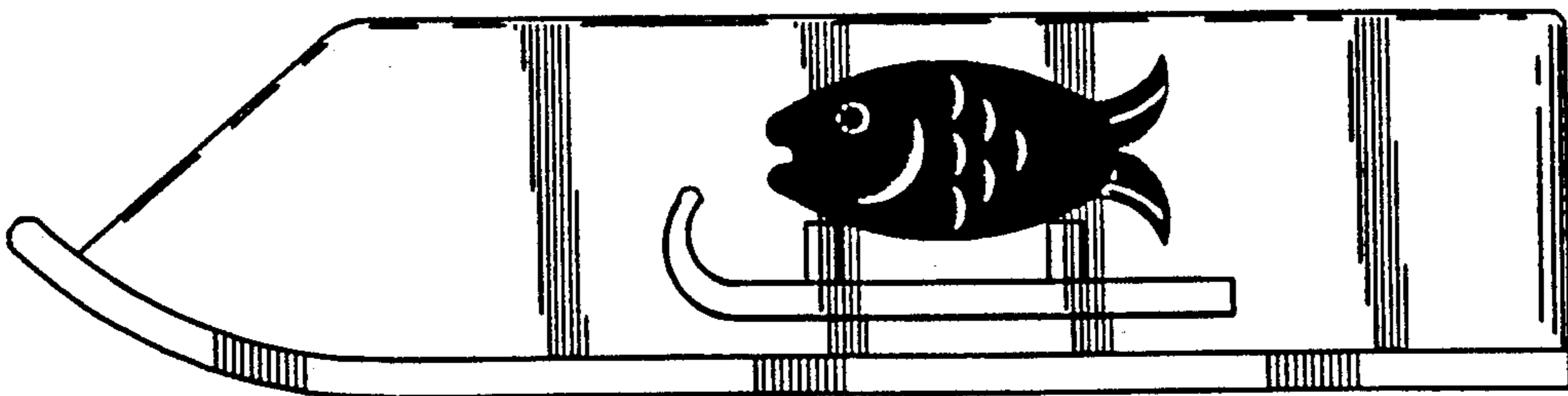

FIG. 5

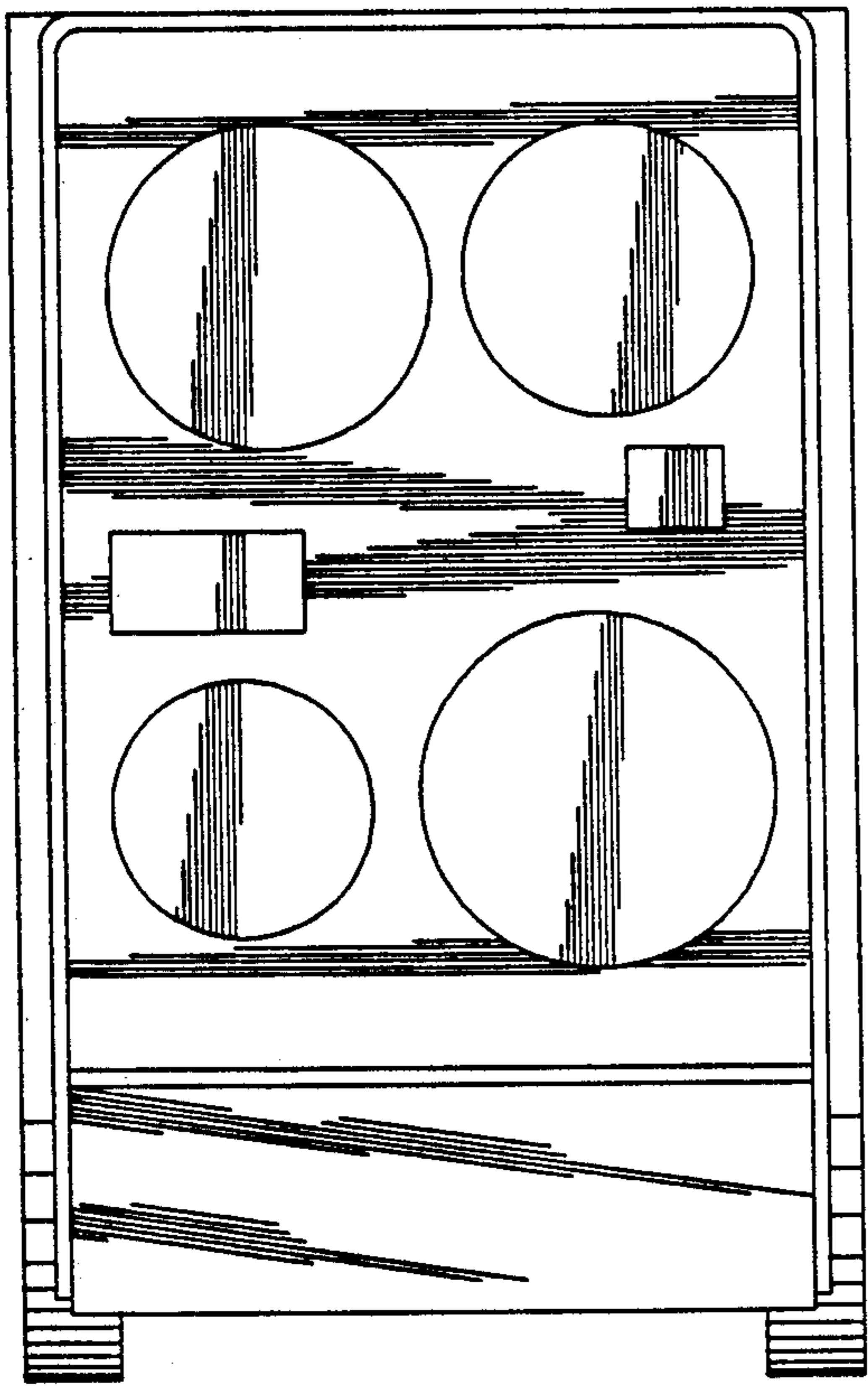

FIG. 6

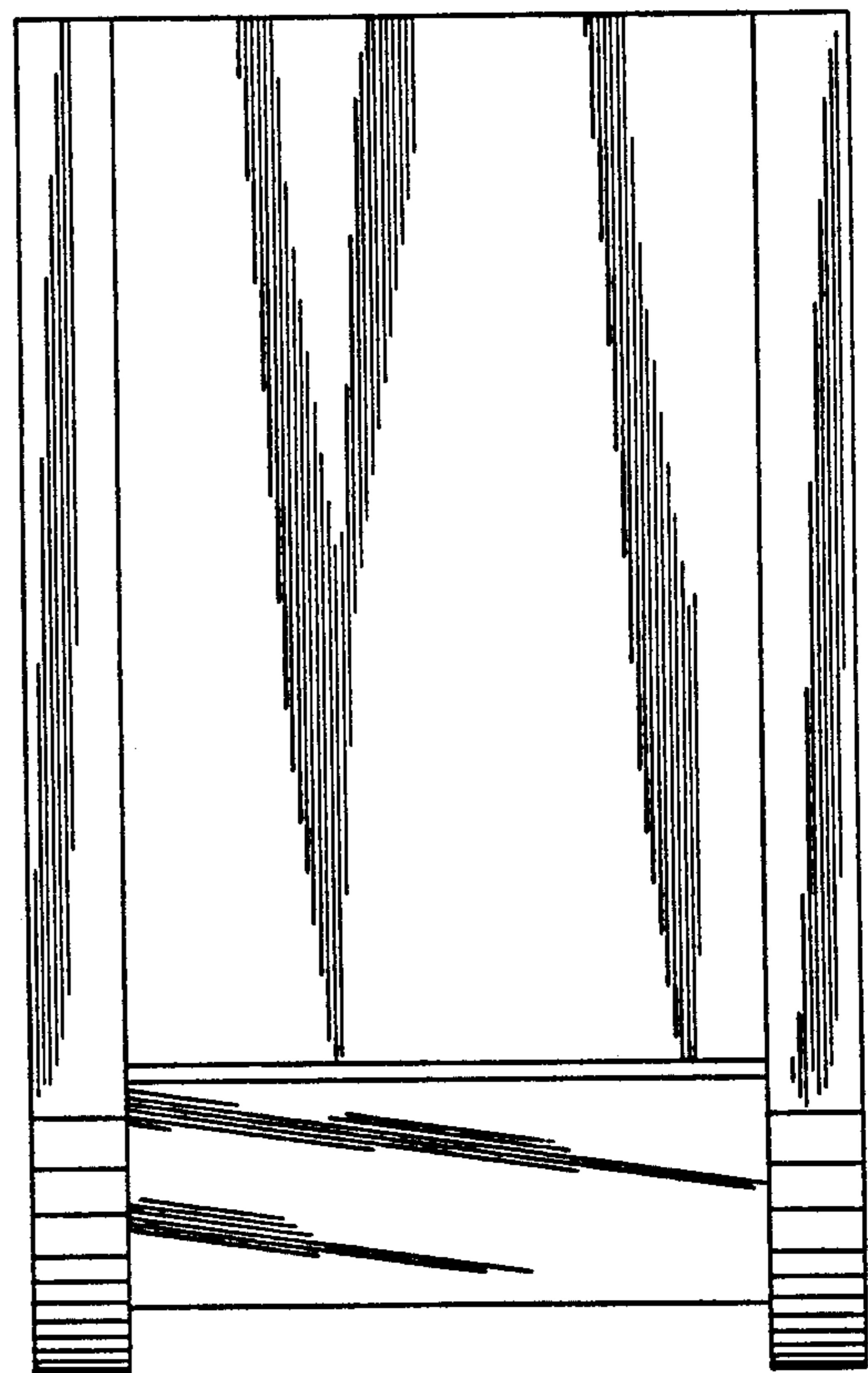

FIG. 7

