



US00D339760S

# United States Patent [19]

[11] Patent Number: **Des. 339,760**

Lucero et al.

[45] Date of Patent: **\*\* Sep. 28, 1993**

[54] DOORBELL

[56] References Cited

[76] Inventors: **Luis E. Lucero**, 442 E. 45th St.,  
Hialeah, Fla. 33013; **Mayra J. Lucero**, both of 442 E. 4th St.,  
Hialeah, Fla. 33013

### U.S. PATENT DOCUMENTS

D. 241,316	9/1976	Hoskins .....	D8/404
D. 290,098	6/1987	Jameson .....	D10/121
D. 315,528	3/1991	Hickolett .....	D10/114
1,221,700	4/1917	Deicke .....	172/39
4,455,963	6/1984	Matsuo .....	116/306

[\*\*] Term: **14 Years**

*Primary Examiner*—Wallace R. Burke  
*Assistant Examiner*—Marcus Jackson  
*Attorney, Agent, or Firm*—Leon Gilden

[21] Appl. No.: **845,483**

[57] **CLAIM**

The ornamental design for a doorbell, as shown and described.

[22] Filed: **Mar. 6, 1992**

### DESCRIPTION

#### Related U.S. Application Data

[63] Continuation-in-part of Ser. No. 402,268, Sep. 5, 1989, abandoned.

[52] U.S. Cl. .... **D10/118**

[58] Field of Search ..... **D10/108, 120, 121, 118;**  
**D20/10, 33; 116/148, 171, 172, 200; D8/400,**  
**401, 404**

FIG. 1 is a front elevational view of the doorbell showing my new design;

FIG. 2 is a rear elevational view thereof with the cord broken away to indicate indeterminate length;

FIG. 3 is a left side elevational view thereof;

FIG. 4 is a right side elevational view thereof;

FIG. 5 is a top plan view thereof; and,

FIG. 6 is a bottom plan view thereof.

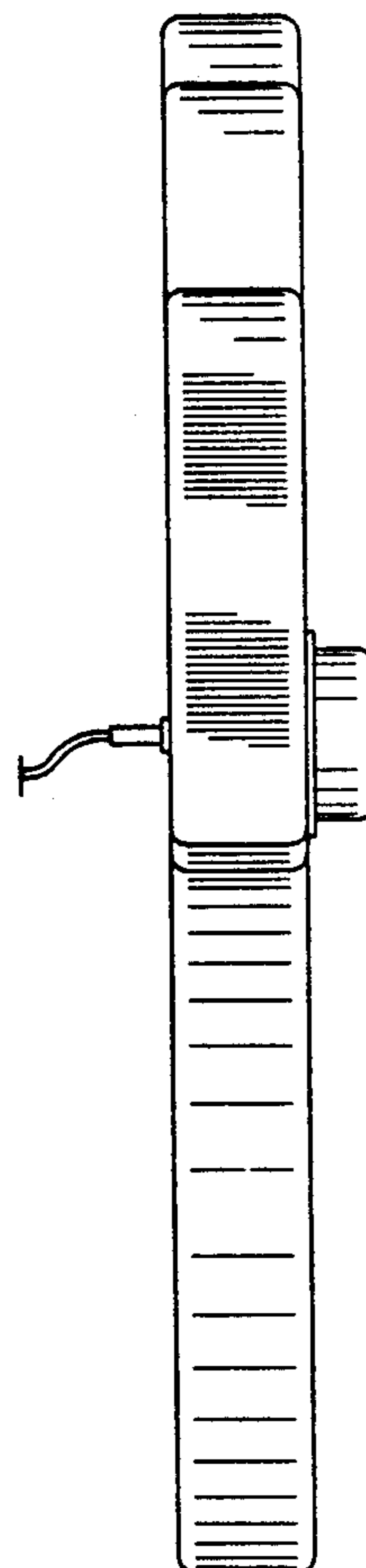
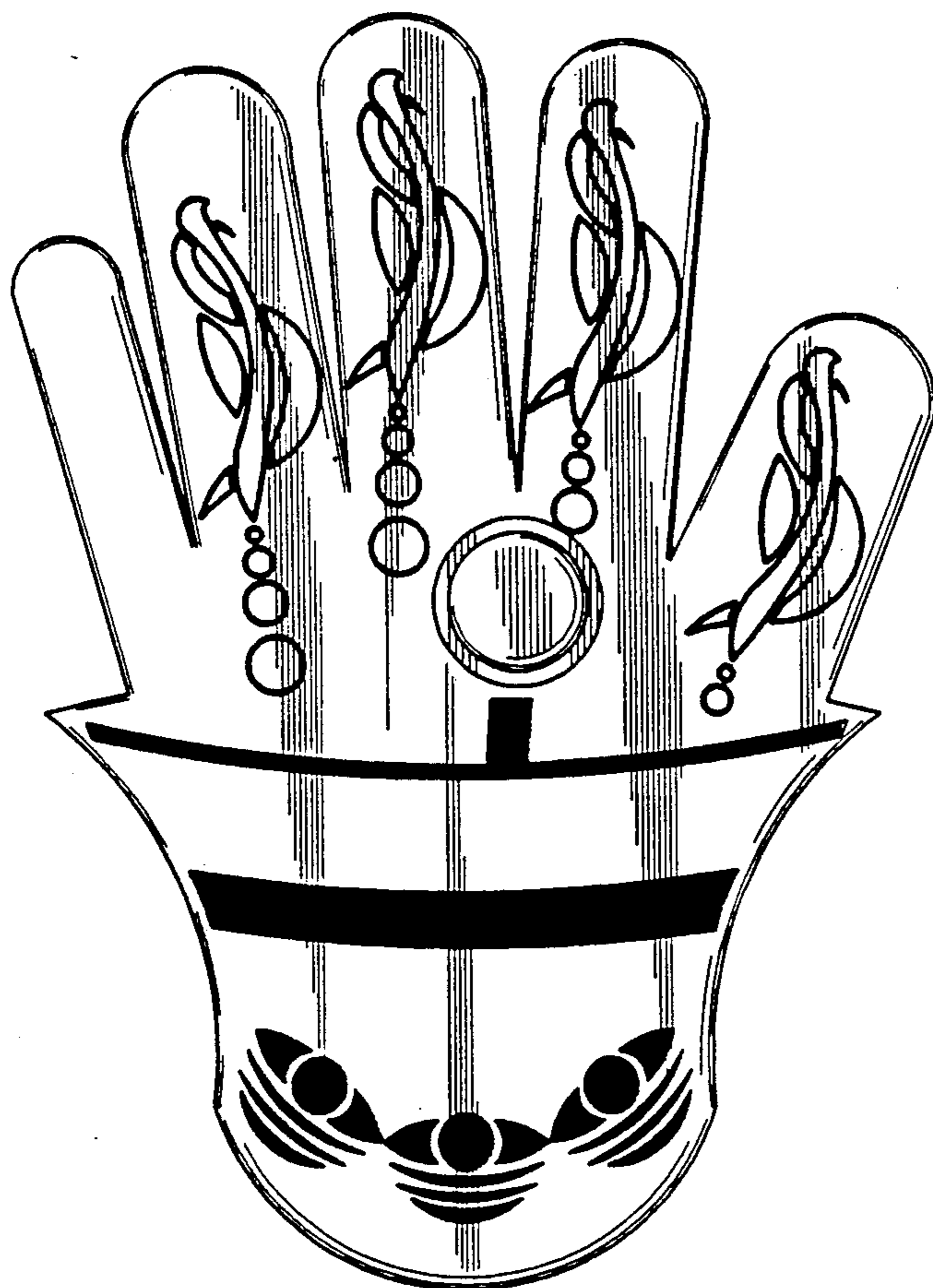

FIG. 1

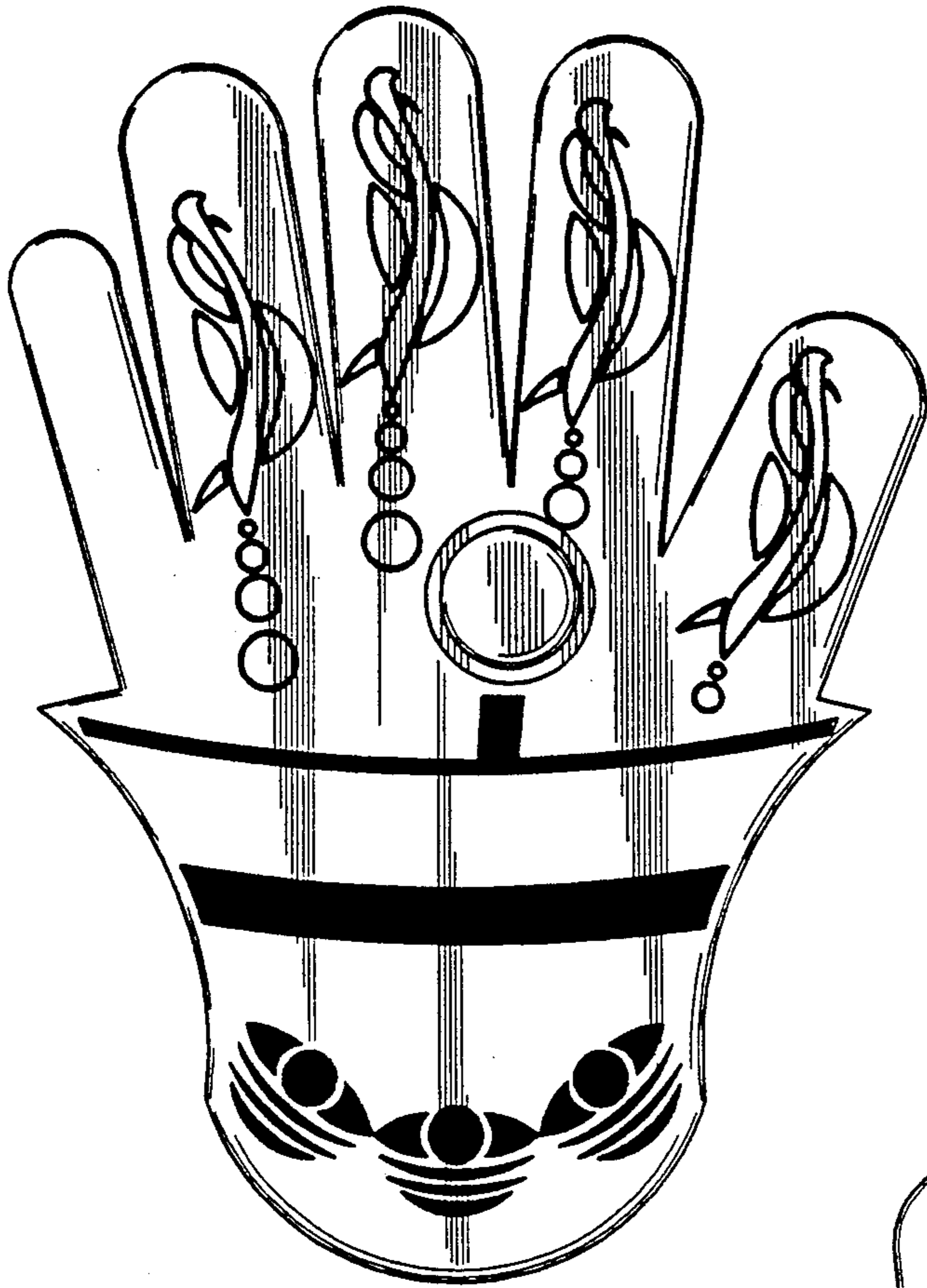

FIG. 2

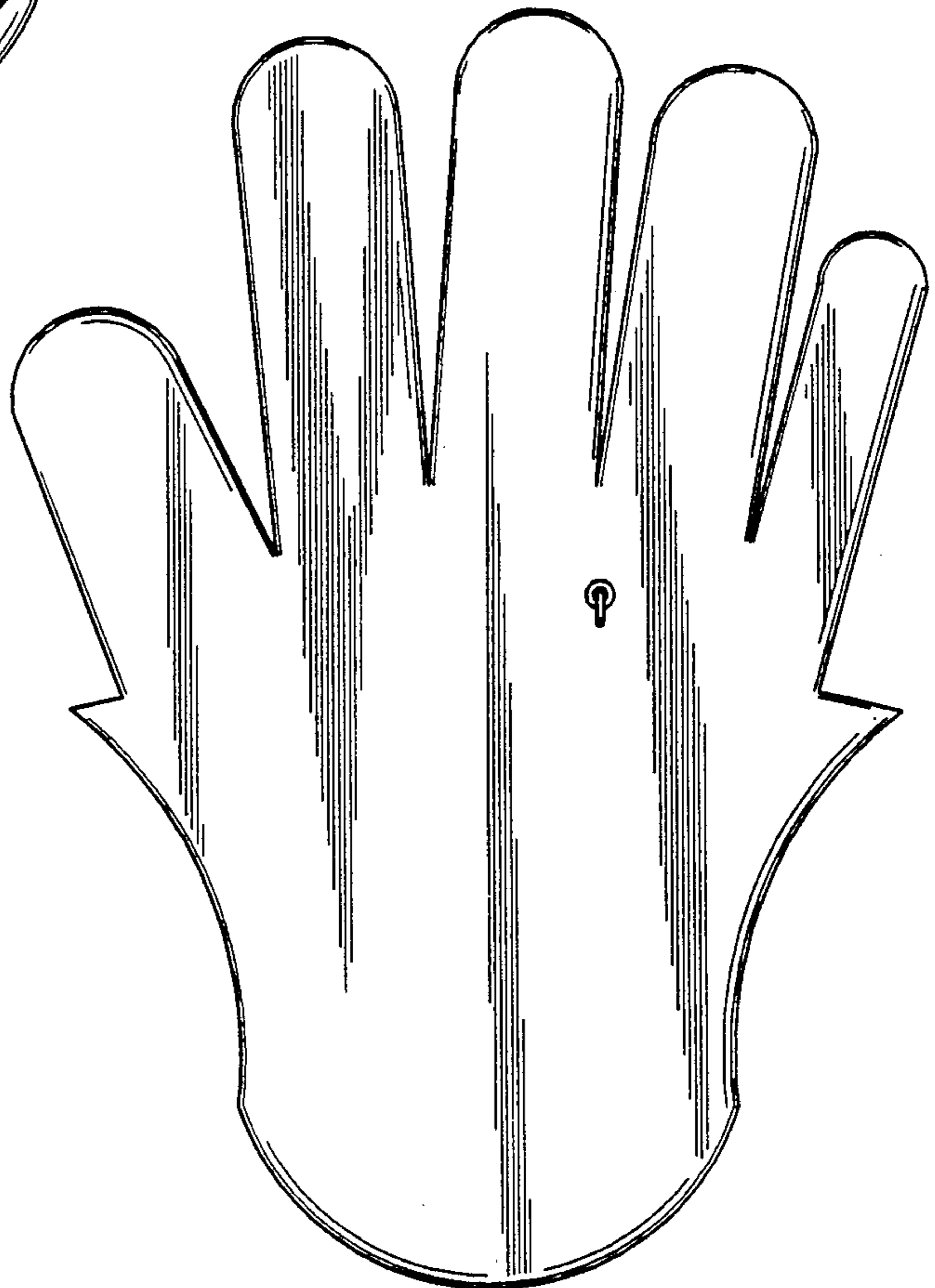

FIG. 3

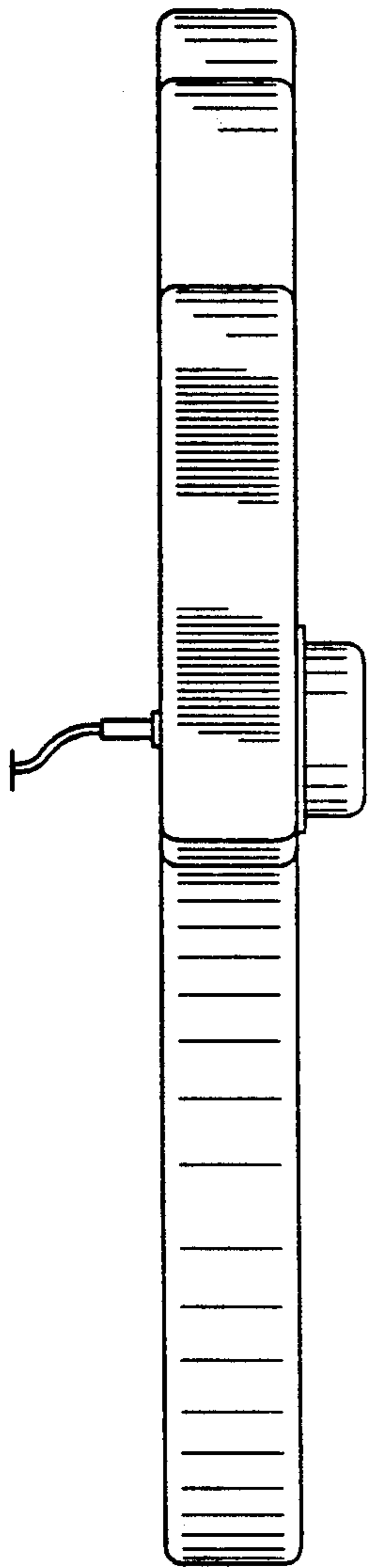

FIG. 4

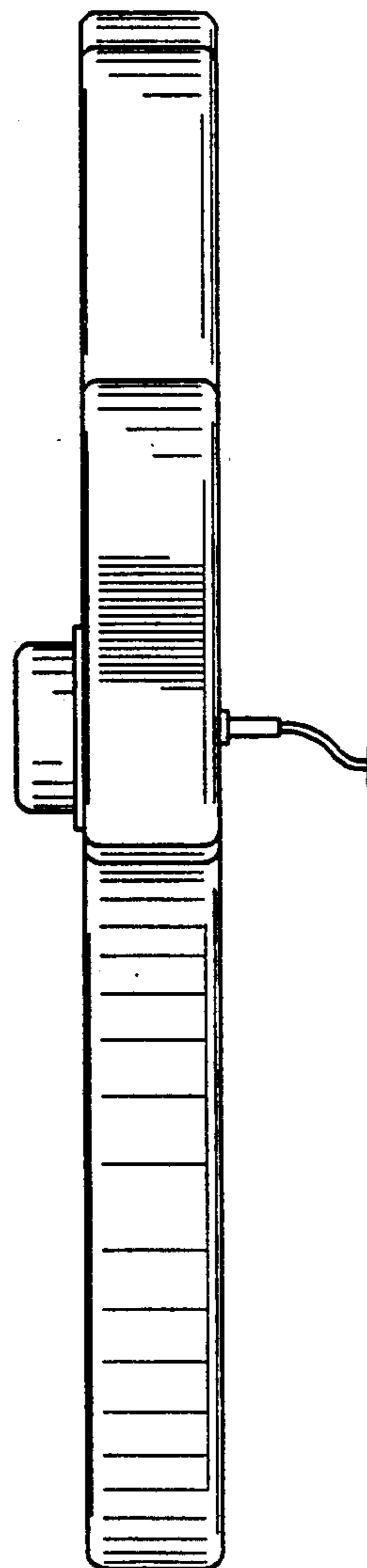

FIG. 5

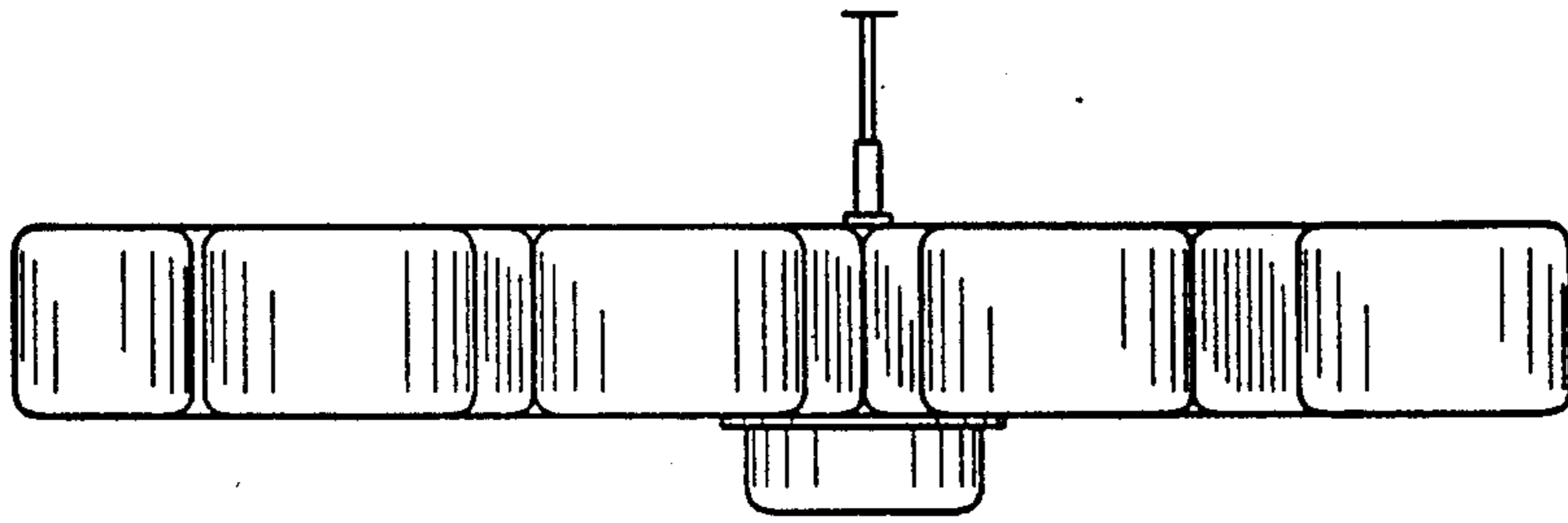

FIG. 6

