



US00D339658S

United States Patent [19]

[11] Patent Number: **Des. 339,658**

Lahteenmaki et al.

[45] Date of Patent: **** Sep. 21, 1993**

[54] **RESPIRATOR**

[75] Inventors: **Reino Lahteenmaki, Turku; Jouni Teittinen, Raisio, both of Finland**

[73] Assignee: **Air-Ace Oy, Jyvaskyla, Finland**

[**] Term: **14 Years**

[21] Appl. No.: **784,805**

[22] Filed: **Oct. 30, 1991**

[30] **Foreign Application Priority Data**

May 2, 1991 [FR] France 393/91

[52] U.S. Cl. **D29/7; D29/8**

[58] Field of Search **D29/6-9; 128/206.15, 206.17, 206.16, 206.12, 206.24, 207.13**

[56] **References Cited**

U.S. PATENT DOCUMENTS

- D. 270,957 10/1983 Maryyanek et al. D29/7
- 3,902,485 9/1975 Wallace .
- 3,911,413 10/1975 Wallace .
- 4,155,358 5/1979 McAllister et al. .
- 4,873,970 10/1989 Freidank et al. .

- 4,886,058 12/1989 Brostrom et al. .
- 4,981,134 1/1991 Courtney 128/206.15

FOREIGN PATENT DOCUMENTS

- 0258508 5/1986 European Pat. Off. .
- 52929 5/1972 Finland .
- 833000 2/1985 Finland .
- 1575813 1/1977 United Kingdom .

Primary Examiner—Kay H. Chin
Attorney, Agent, or Firm—Kane, Dalsimer, Sullivan, Kurucz, Levy, Eisele & Richard

[57] **CLAIM**

The ornamental design for a respirator, as shown and described.

DESCRIPTION

FIG. 1 is a front elevational view of a respirator or similar article showing our design; FIG. 2 is a top plan view thereof; FIG. 3 is a left end view thereof; FIG. 4 is a right end view thereof; FIG. 5 is a bottom plan view thereof; FIG. 6 is a rear elevational view thereof; and, FIG. 7 is a front perspective view thereof.

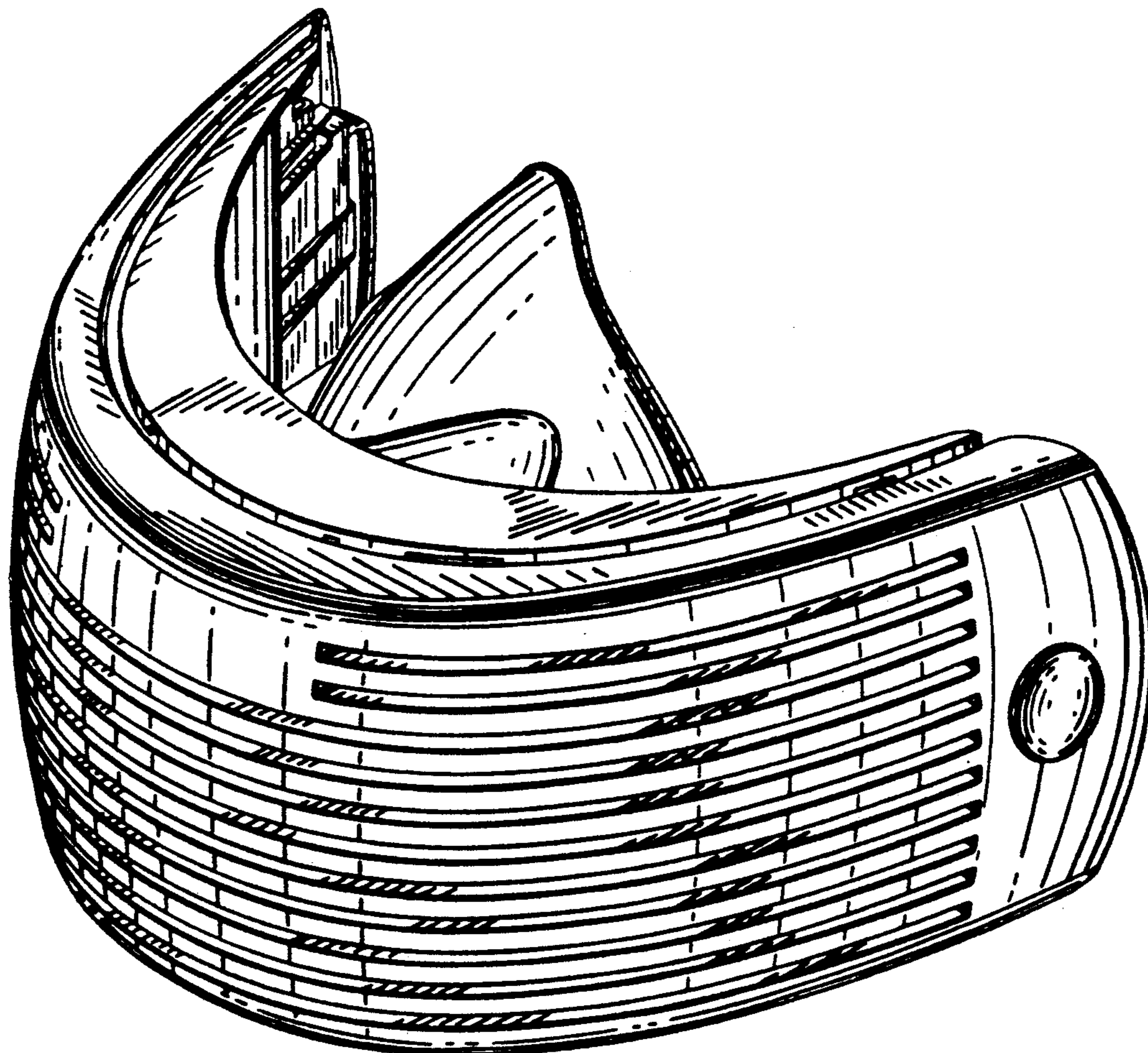

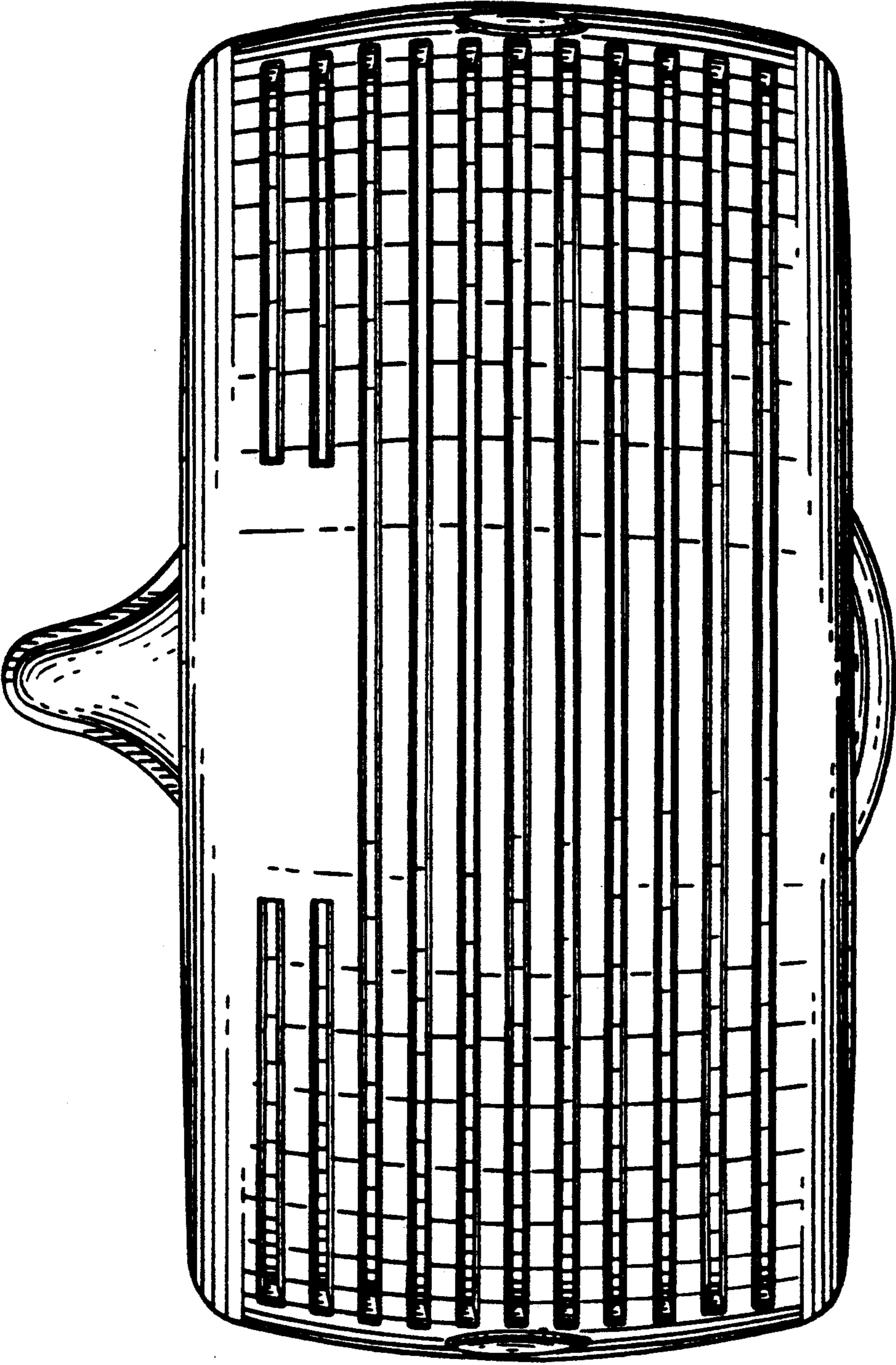

FIG. 1

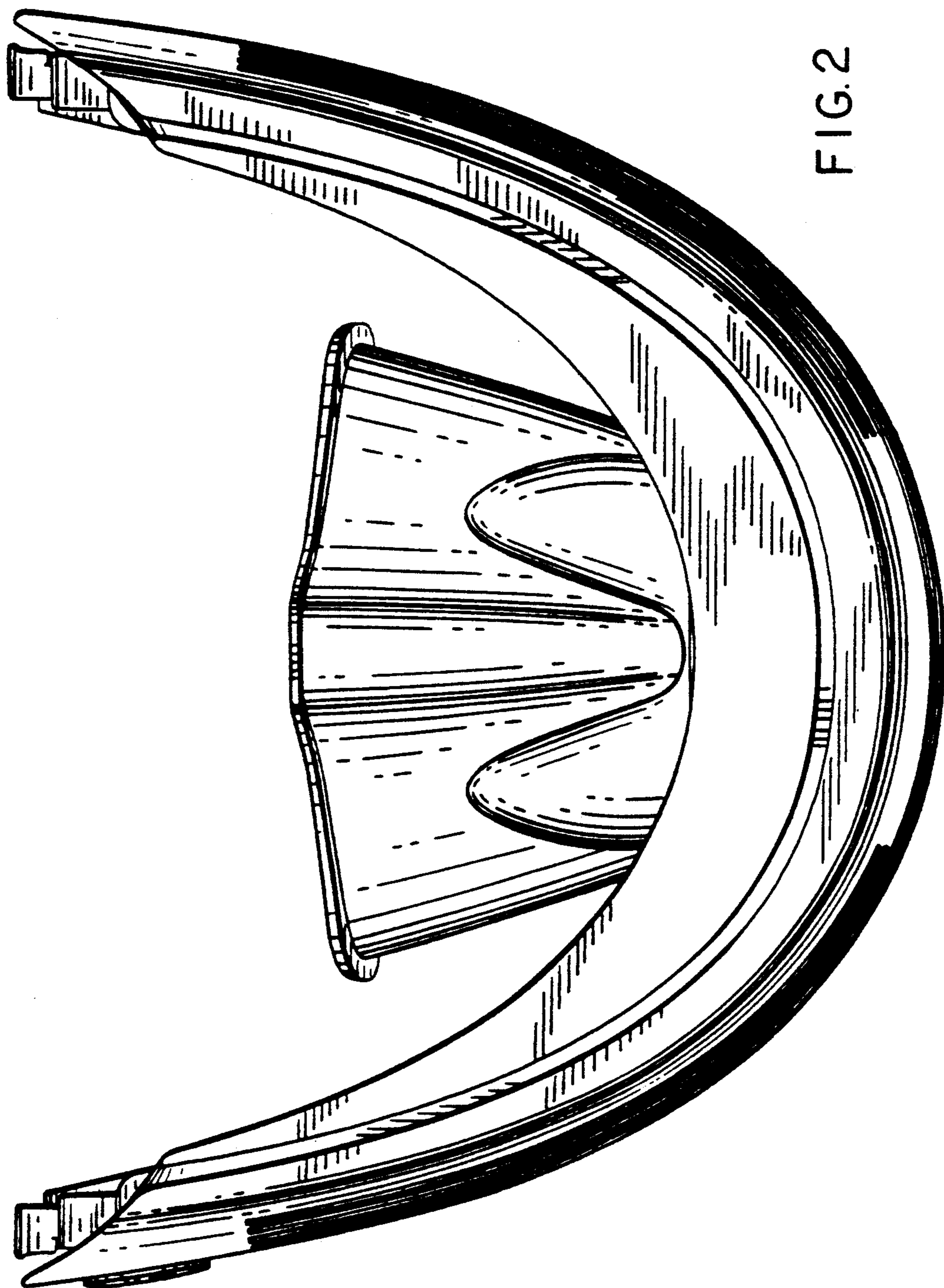

FIG. 2

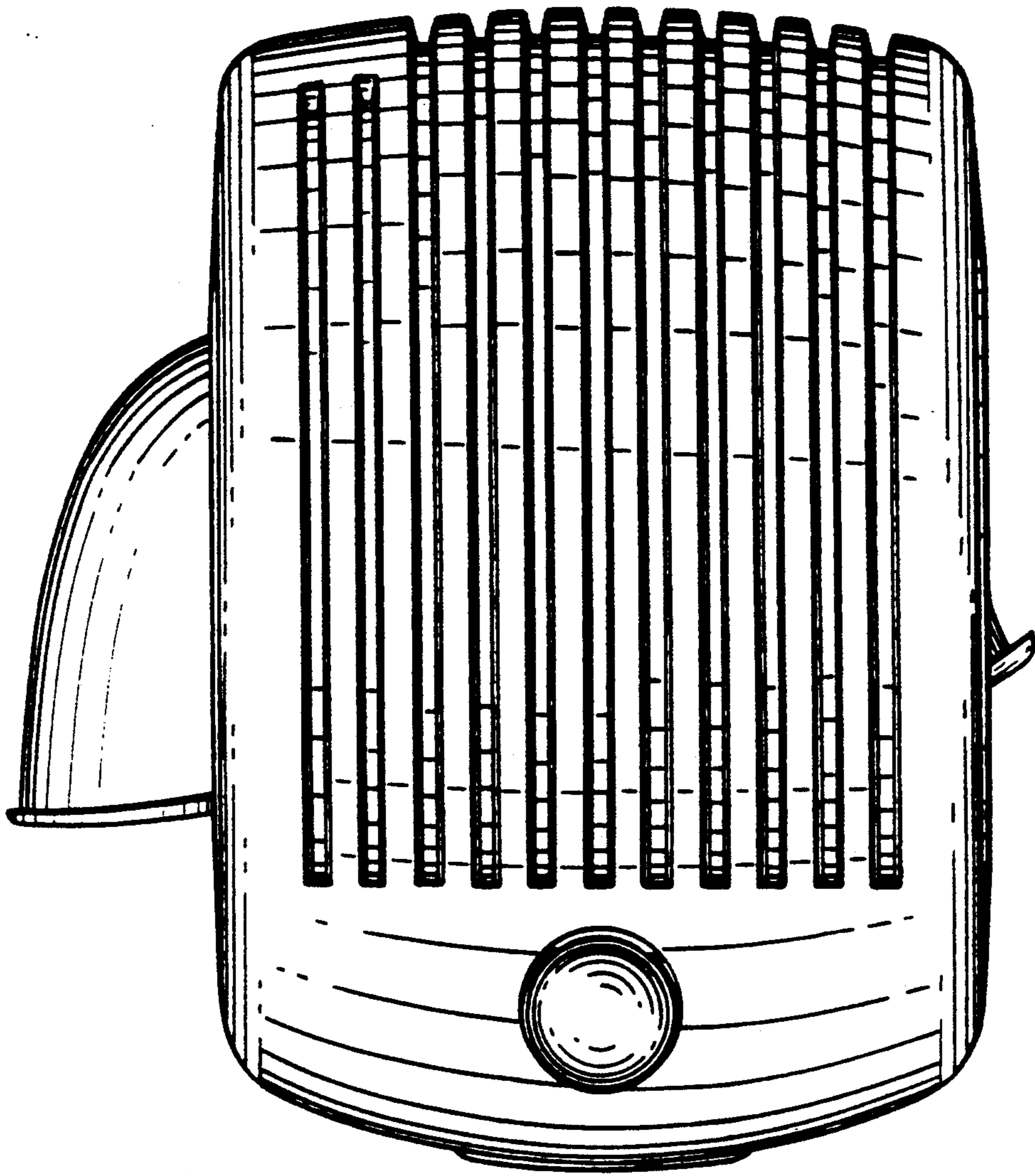

FIG. 3

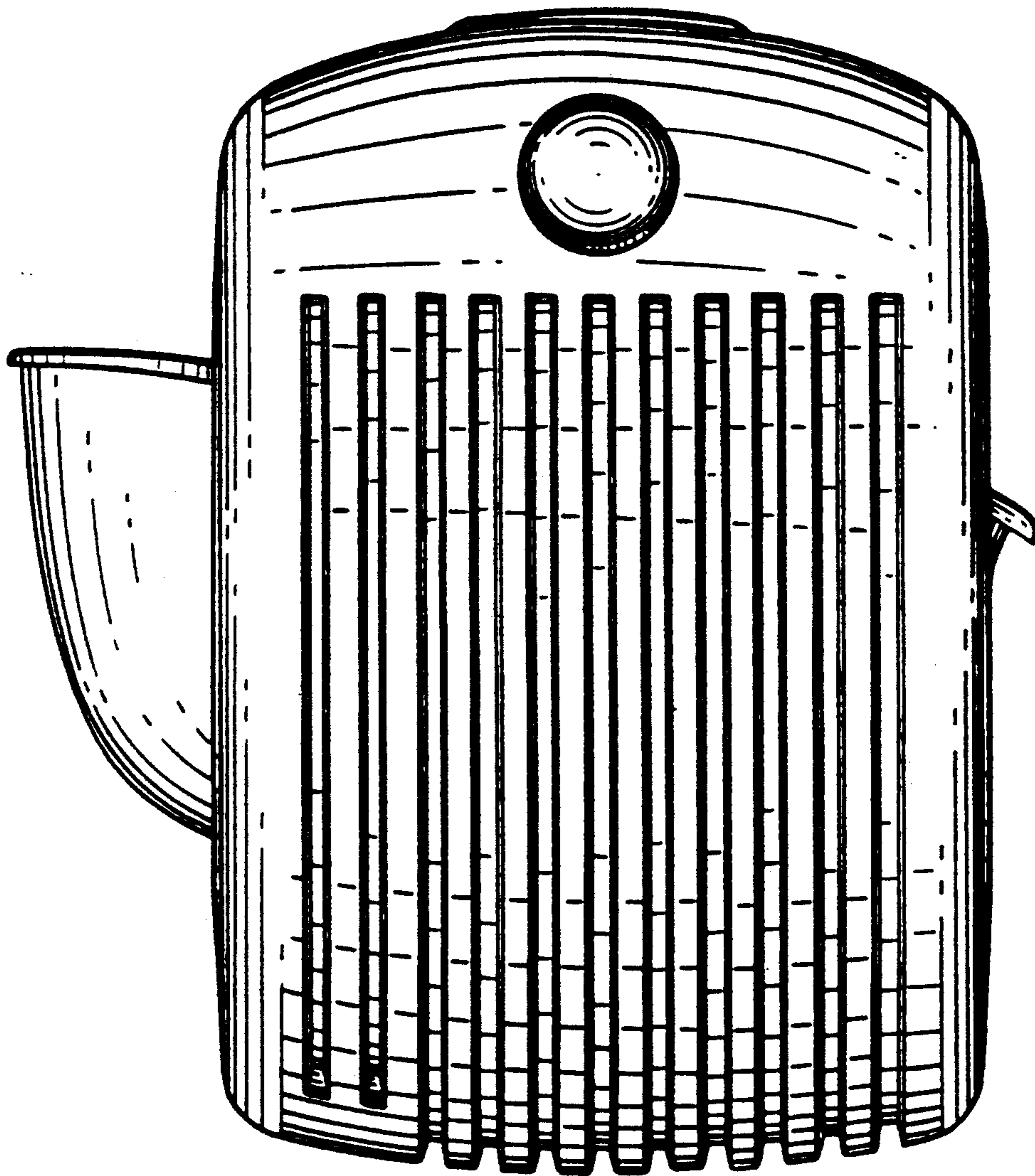

FIG. 4

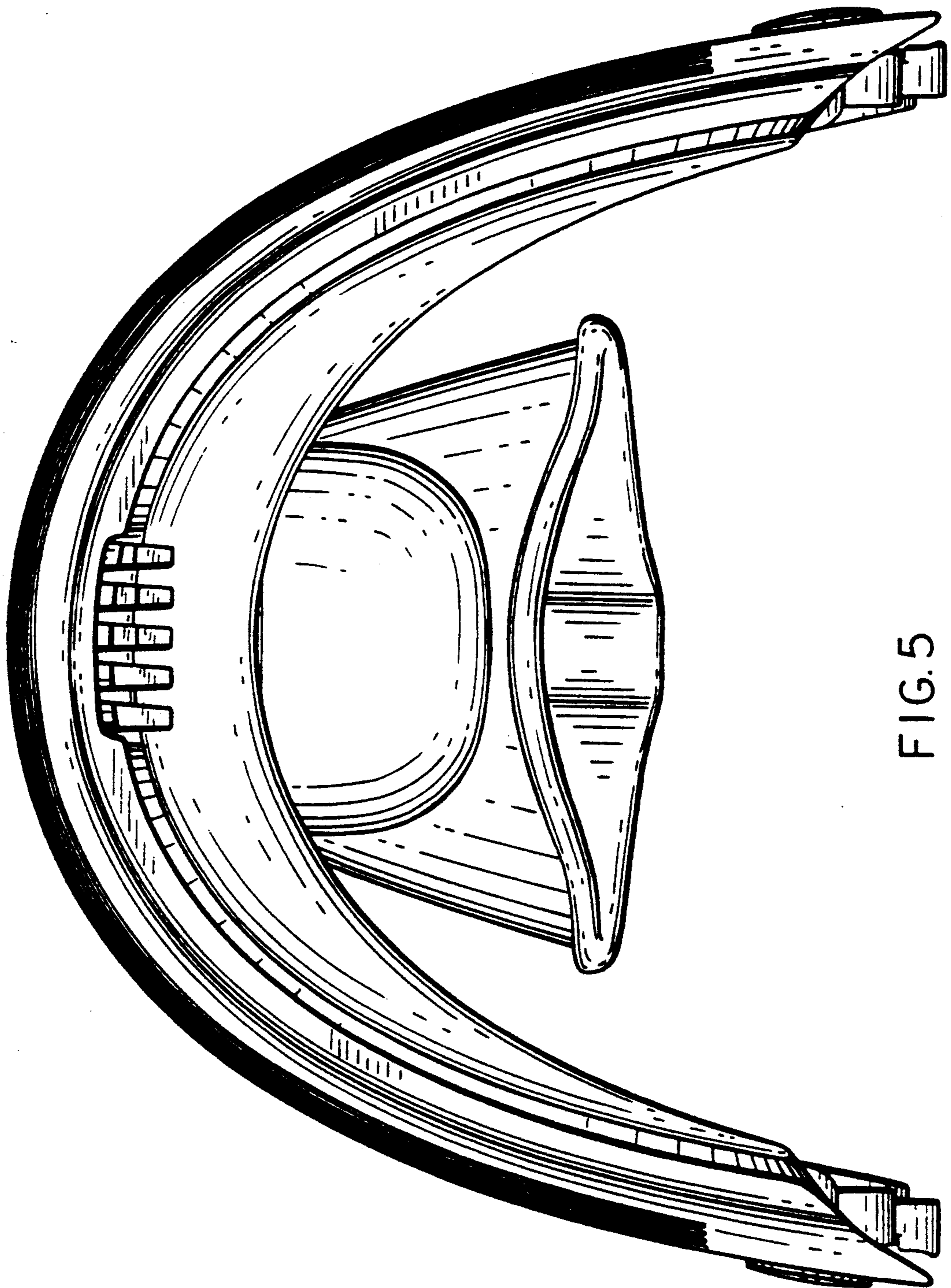

FIG. 5

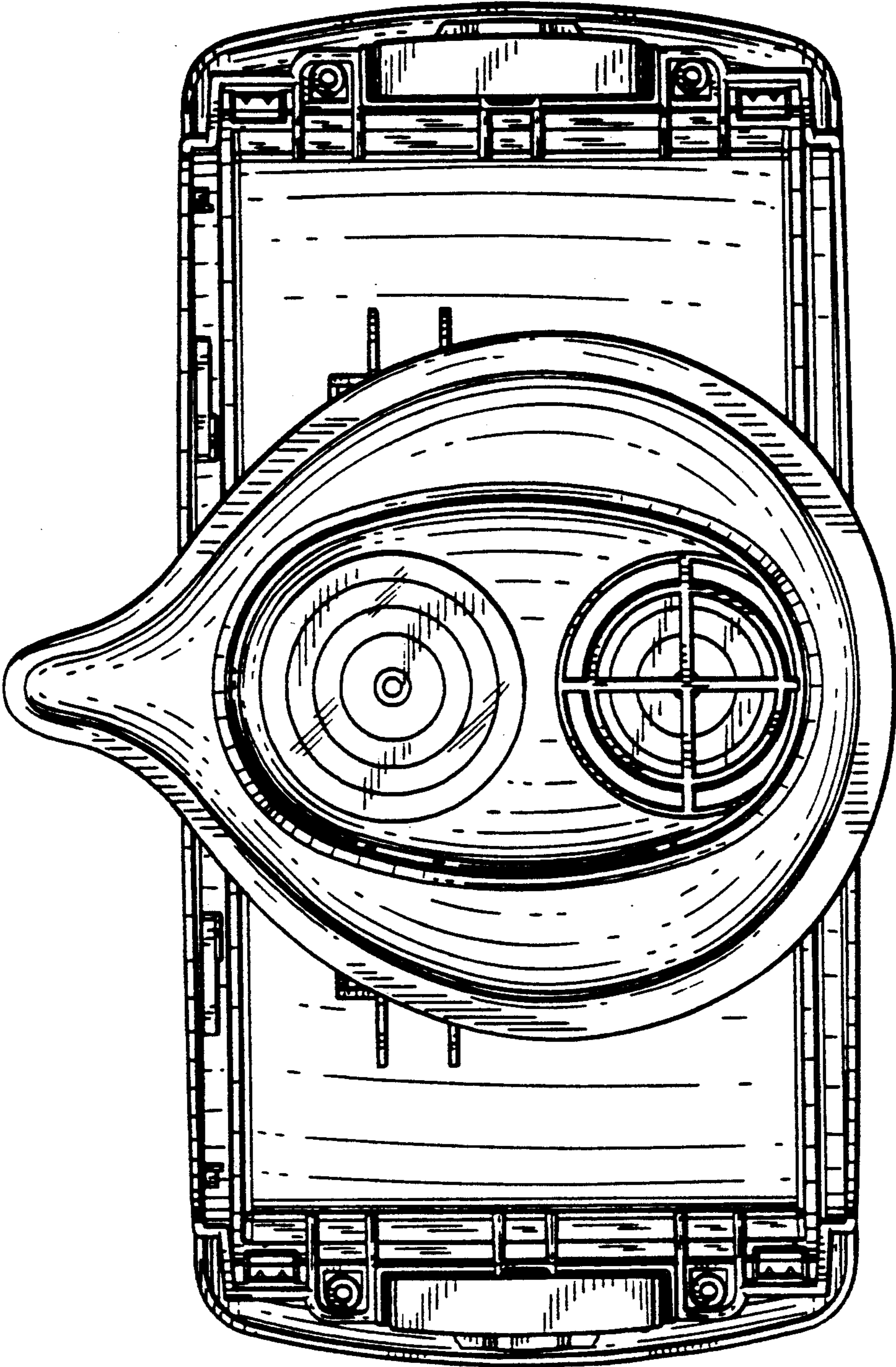
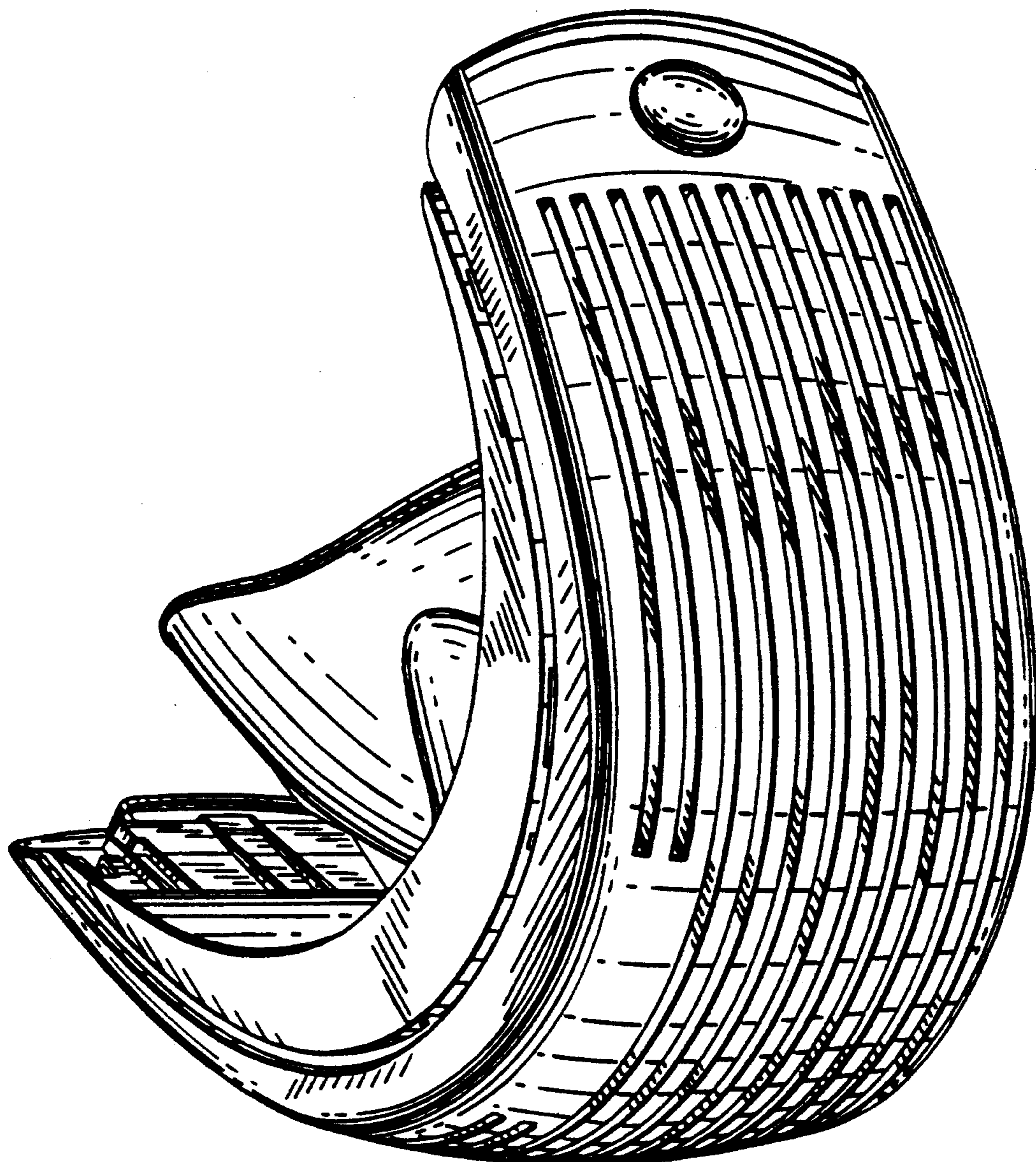

FIG. 6

FIG. 7



UNITED STATES PATENT AND TRADEMARK OFFICE
CERTIFICATE OF CORRECTION

PATENT NO. : D 339,658
DATED : September 21, 1993
INVENTOR(S) : Reino Lahteenmaki

It is certified that error appears in the above-identified patent and that said Letters Patent is hereby corrected as shown below:

On the title page

Item [30] Foreign Application Priority Data

"[FR] France" should be -- [FI] Finland--.

Signed and Sealed this
Twelfth Day of April, 1994



BRUCE LEHMAN

Commissioner of Patents and Trademarks

Attest:

Attesting Officer