



US00D339655S

# United States Patent [19]

[11] Patent Number: Des. 339,655

Sulik

[45] Date of Patent: \*\* Sep. 21, 1993

[54] HAIR TRIMMER AND SUPPORT BASE ASSEMBLY

[75] Inventor: Joseph M. Sulik, Beacon Falls, Conn.

[73] Assignee: Remington Products, Inc., Bridgeport, Conn.

[\*\*] Term: 14 Years

[21] Appl. No.: 593,624

[22] Filed: Oct. 5, 1990

[52] U.S. Cl. .... D28/53

[58] Field of Search ..... D28/49-54; 30/34.1, 34.2, 43.1, 42, 43, 200, 210, 216

[56] References Cited

U.S. PATENT DOCUMENTS

D. 274,584	7/1984	Crouse	.....	D6/524
D. 287,648	1/1987	Wahl et al.	.....	D28/54 X
D. 295,682	5/1988	Iwai et al.	.....	D28/53
D. 302,601	8/1989	Uchida	.....	D28/53
D. 304,627	11/1989	Yonesawa	.....	D28/53
D. 305,074	12/1989	Mockovak	.....	D28/53
D. 306,917	3/1990	Terasawa et al.	.....	D28/53
D. 312,546	12/1990	Goldenberg et al.	.....	D6/524 X
D. 320,673	10/1991	Sterk	.....	D28/52
D. 324,546	3/1992	Casolin	.....	D9/341 X

Primary Examiner—Bernard Ansher  
Assistant Examiner—C. Tuttle  
Attorney, Agent, or Firm—Melvin I. Stoltz

[57] CLAIM

The ornamental design for a hair trimmer and support base assembly, as shown and described.

DESCRIPTION

FIG. 1 is a partially exploded front elevational view of a hair trimmer and support base assembly showing my new design;

FIG. 2 is a front elevational view of the clipper element, shown separately for clarity of illustration;

FIG. 3 is a left side elevational view thereof;

FIG. 4 is a right side elevational view thereof;

FIG. 5 is a rear elevational view thereof;

FIG. 6 is a top plan view thereof;

FIG. 7 is a bottom plan view thereof;

FIG. 8 is a top plan view of the hair length controller attachment, shown separately for clarity of illustration;

FIG. 9 is a front elevational view thereof;

FIG. 10 is a bottom plan view thereof;

FIG. 11 is a rear elevational view thereof;

FIG. 12 is a right side elevational view thereof, the side opposite being a mirror image of the side shown;

FIG. 13 is a top plan view of the support base element, shown separately for clarity of illustration;

FIG. 14 is a front elevational view thereof;

FIG. 15 is a right side elevational view thereof, the side opposite being a mirror image of the side shown;

FIG. 16 is a bottom plan view thereof;

FIG. 17 is a rear elevational view thereof;

FIG. 18 is a rear perspective view of the fully assembled hair trimmer and support base assembly; and,

FIG. 19 is a front perspective view of the fully assembled hair trimmer and support base assembly.

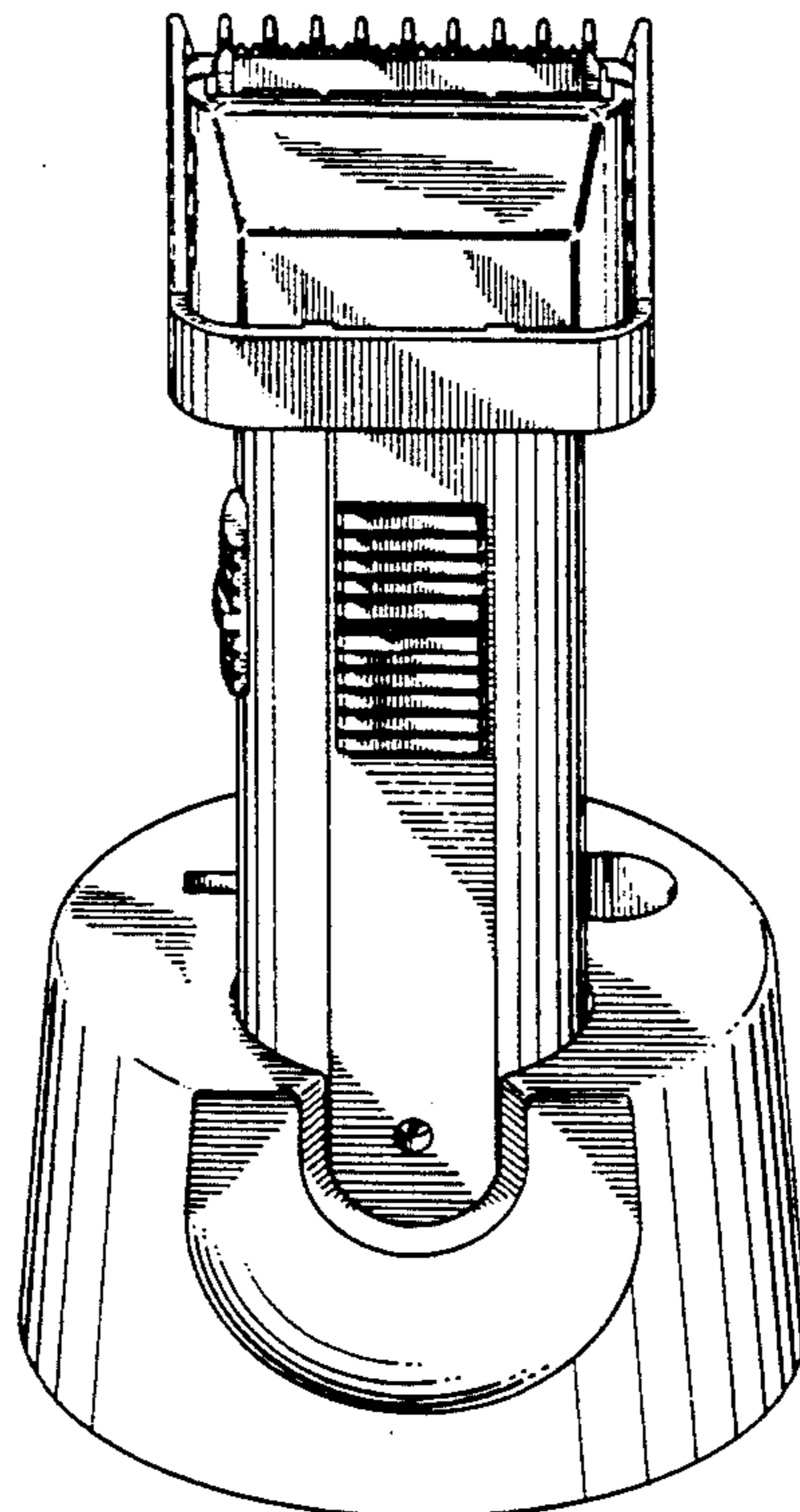

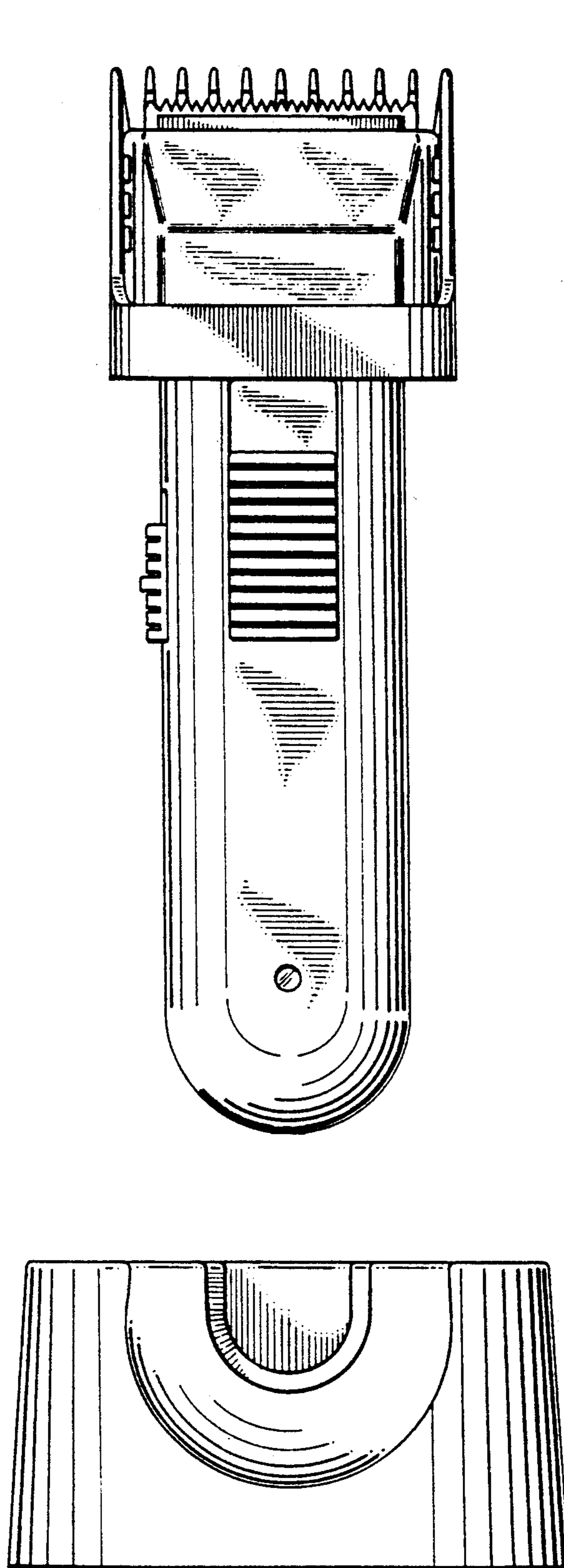

FIG. 1

FIG. 6

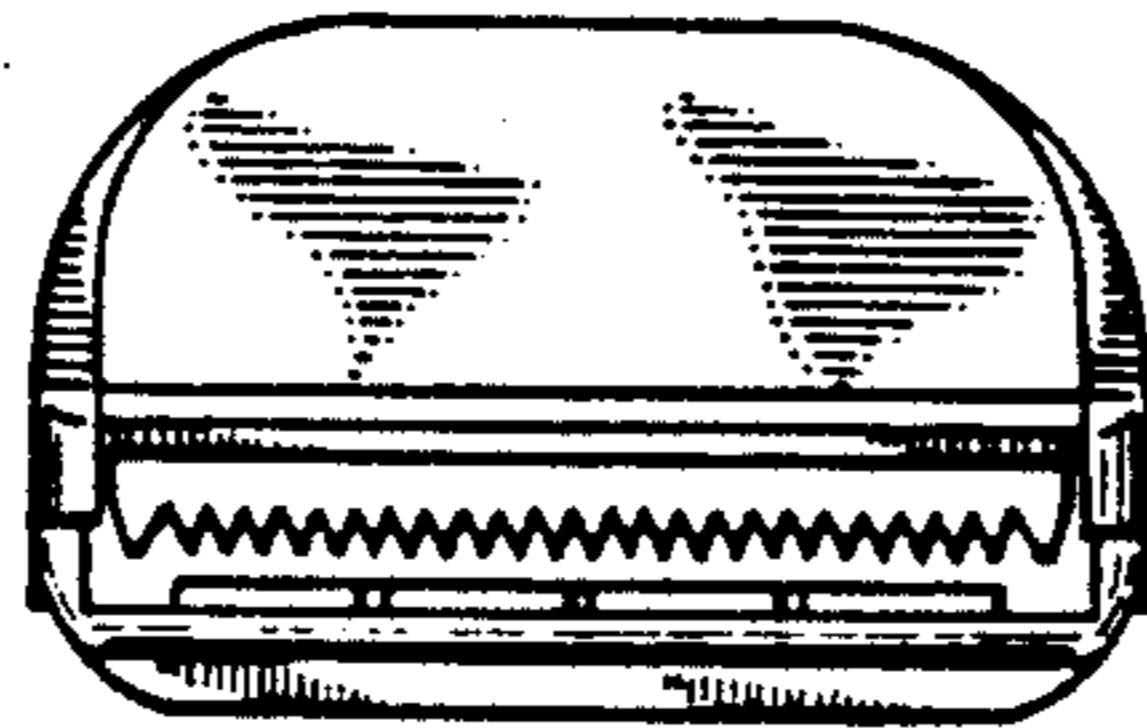

FIG. 3

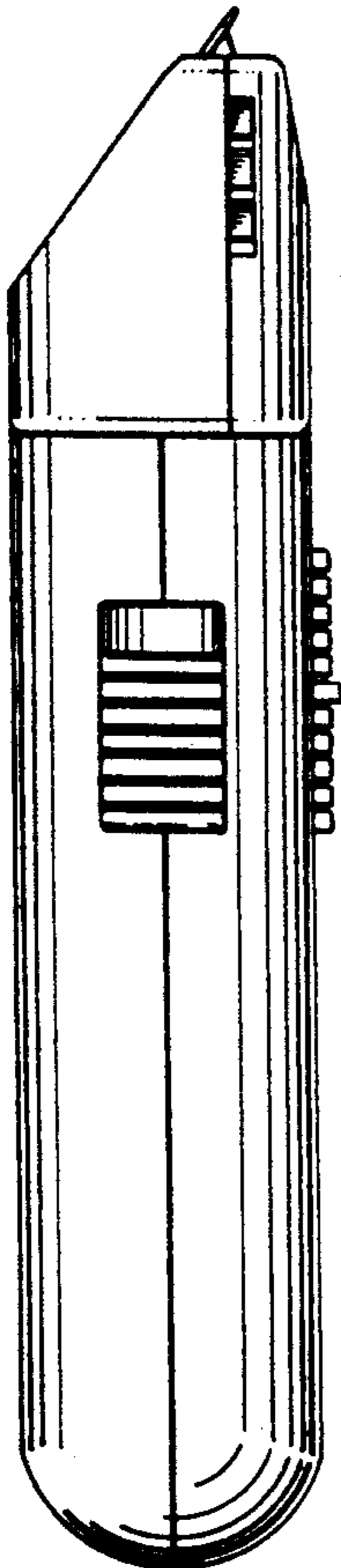

FIG. 2

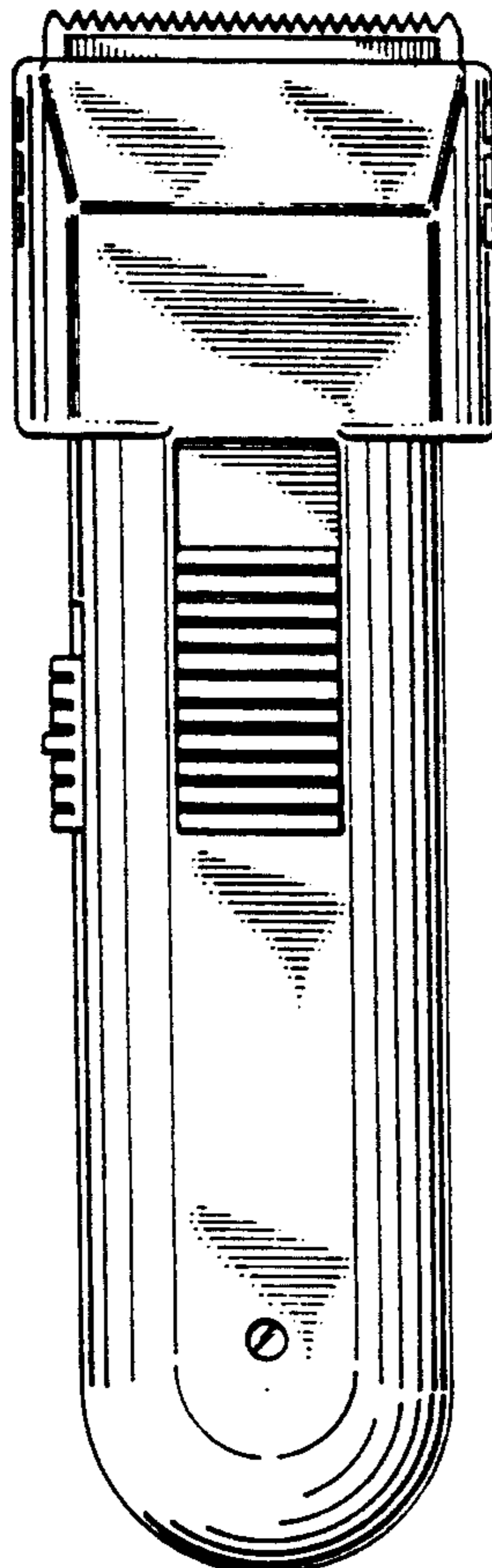

FIG. 4

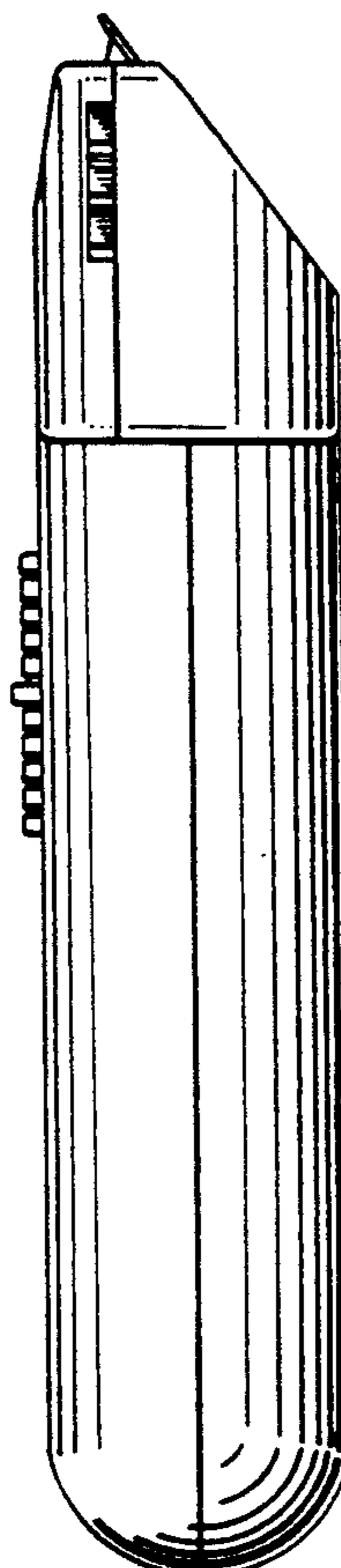

FIG. 5

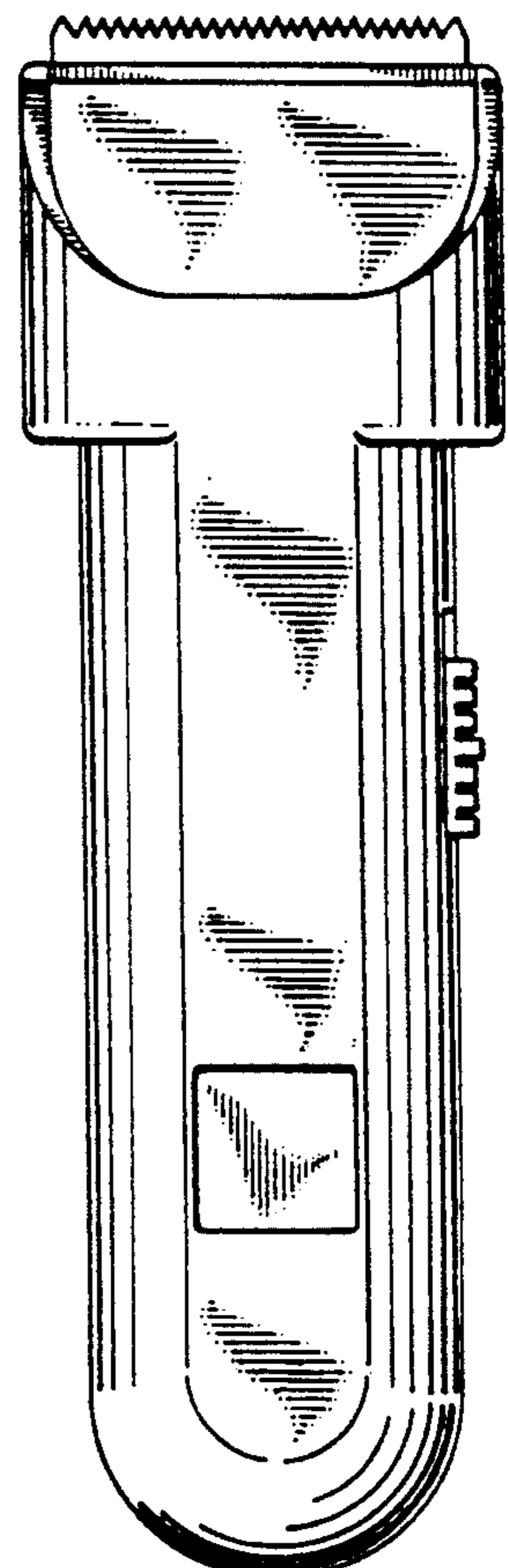

FIG. 7

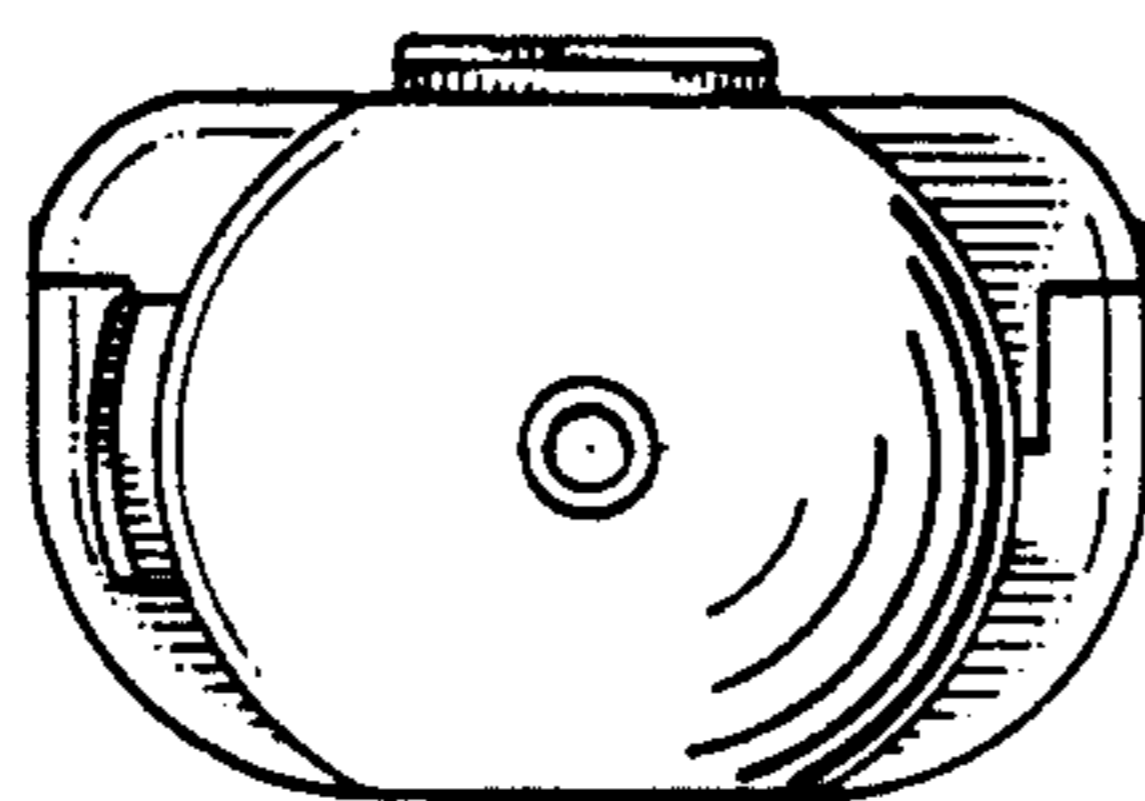

FIG. 8

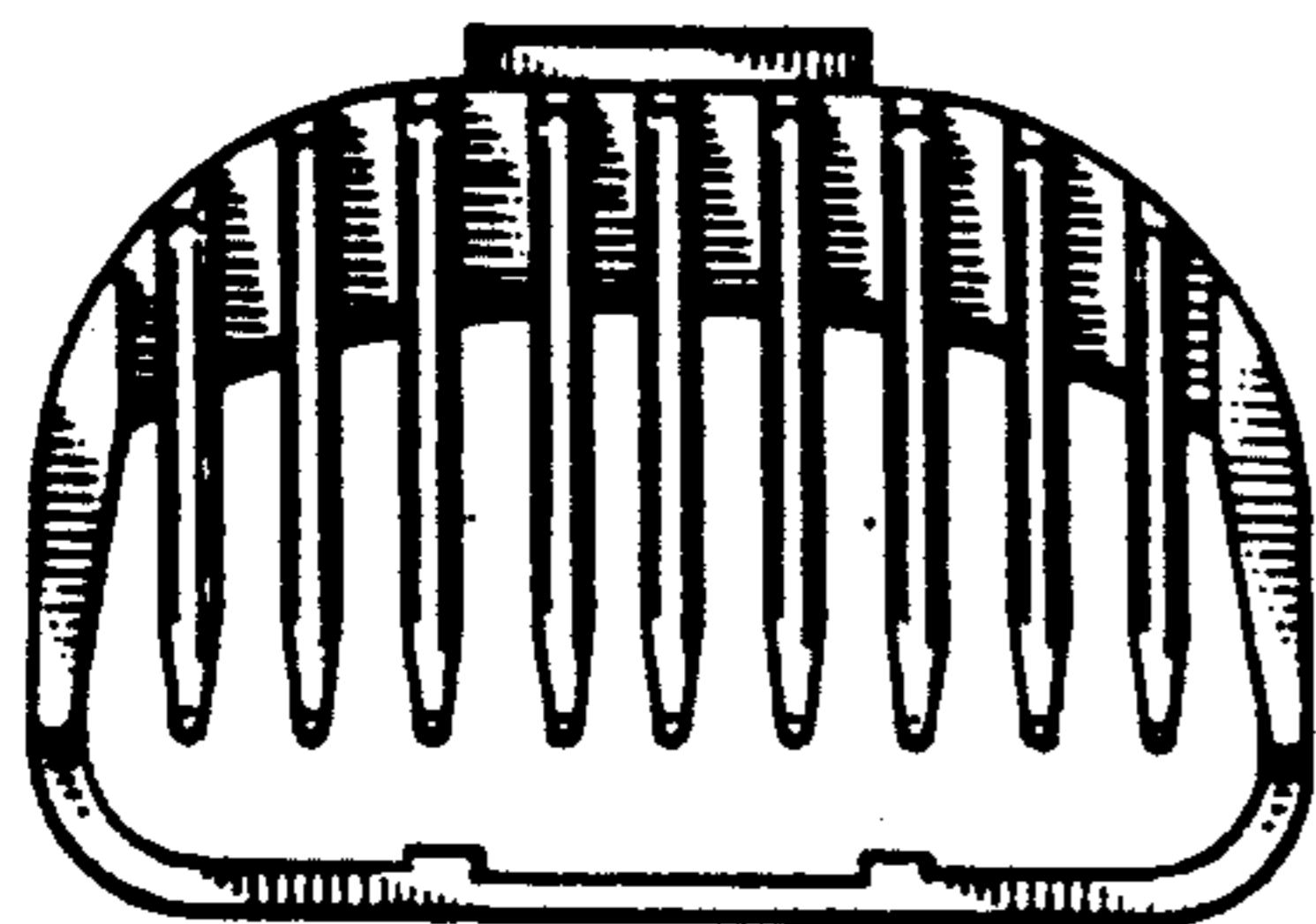

FIG. 11

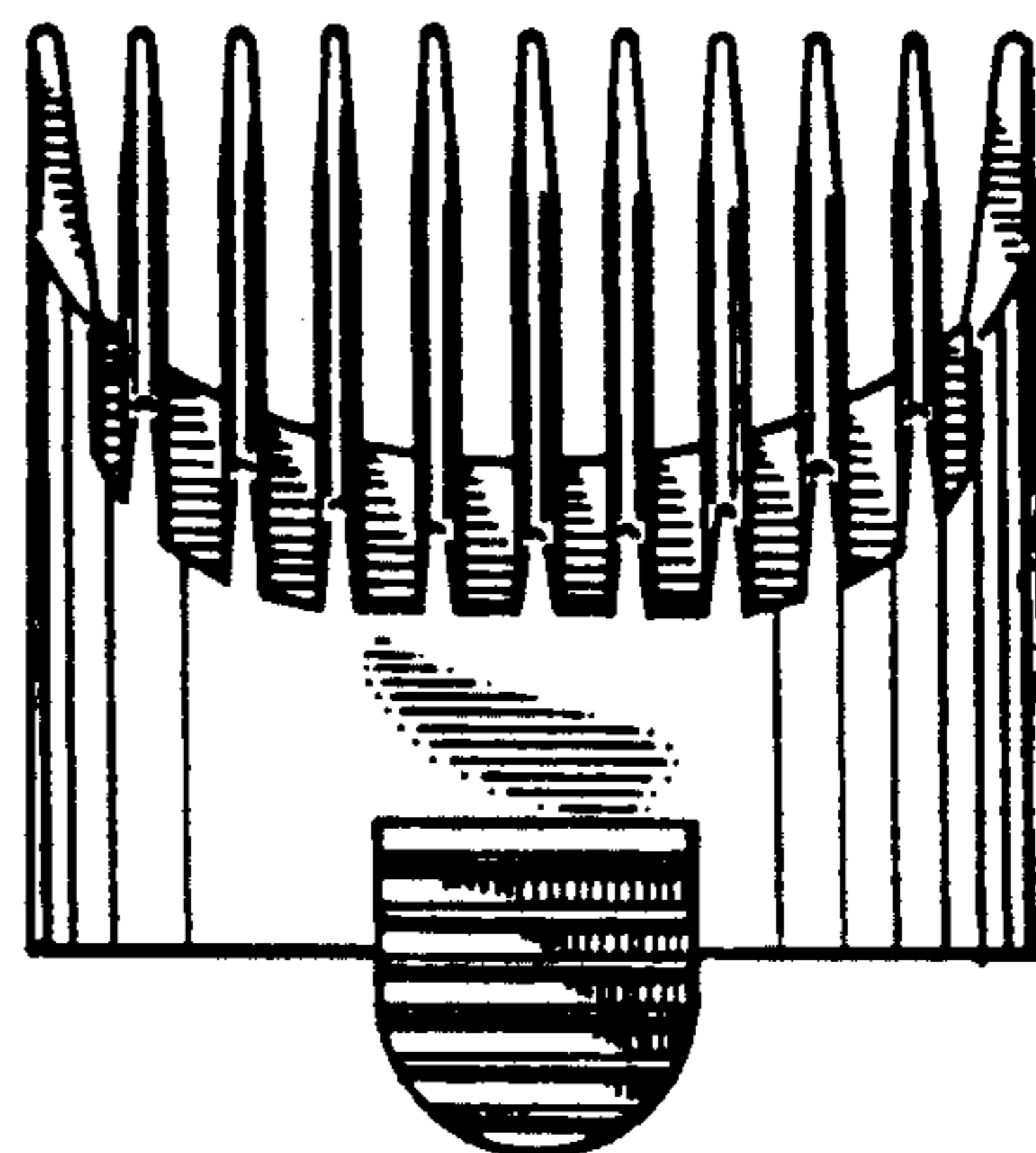

FIG. 9

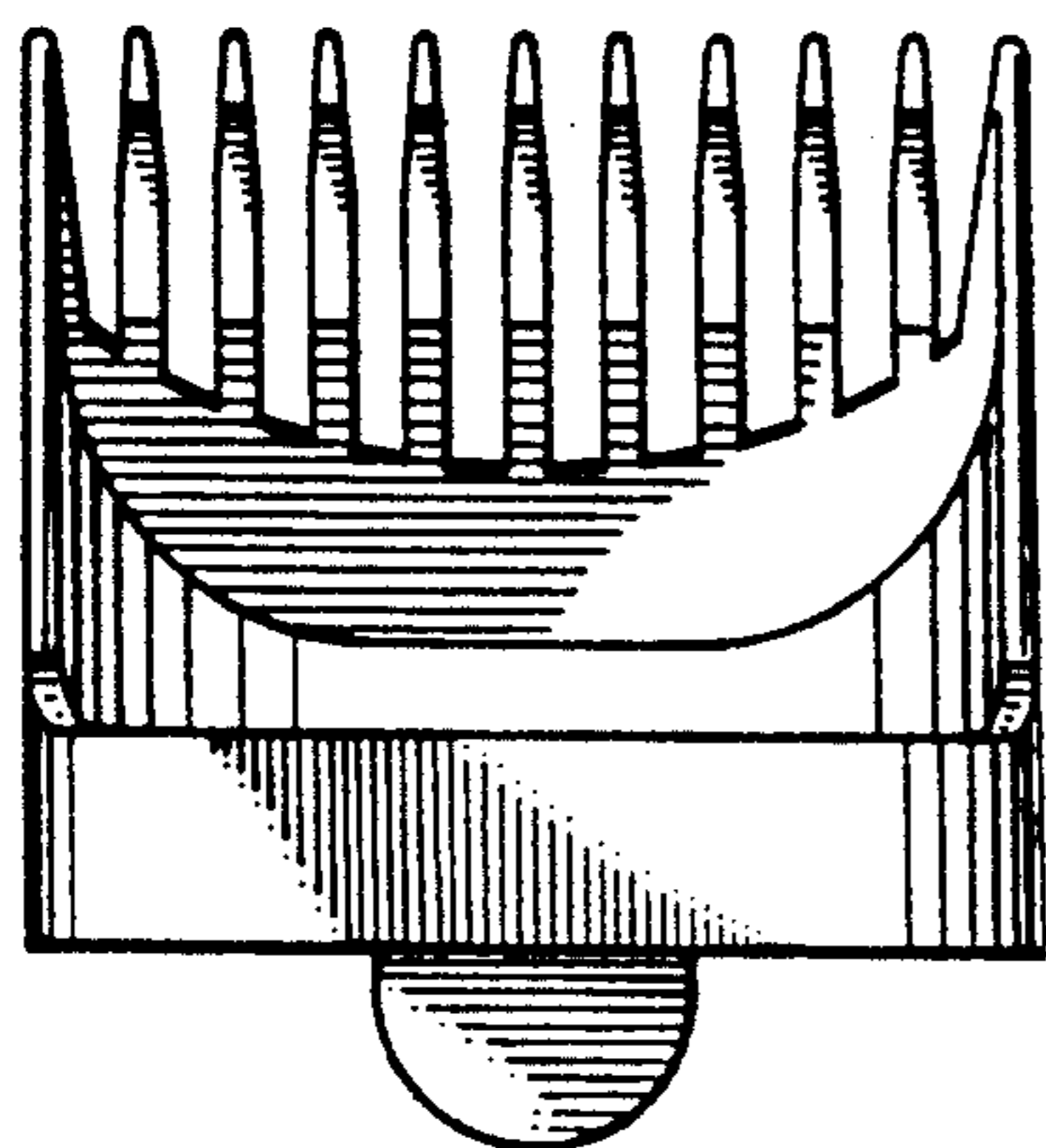

FIG. 12

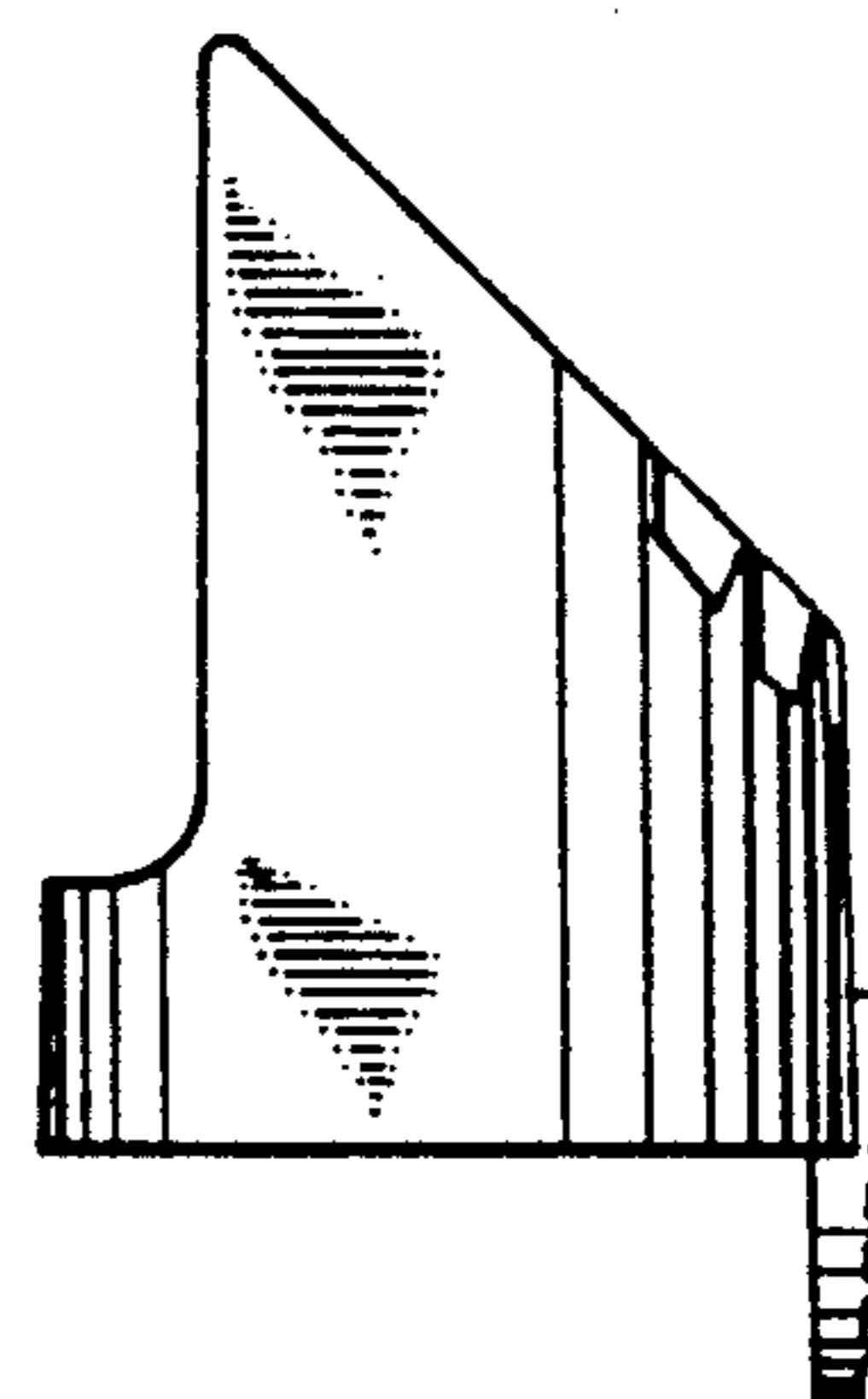

FIG. 10

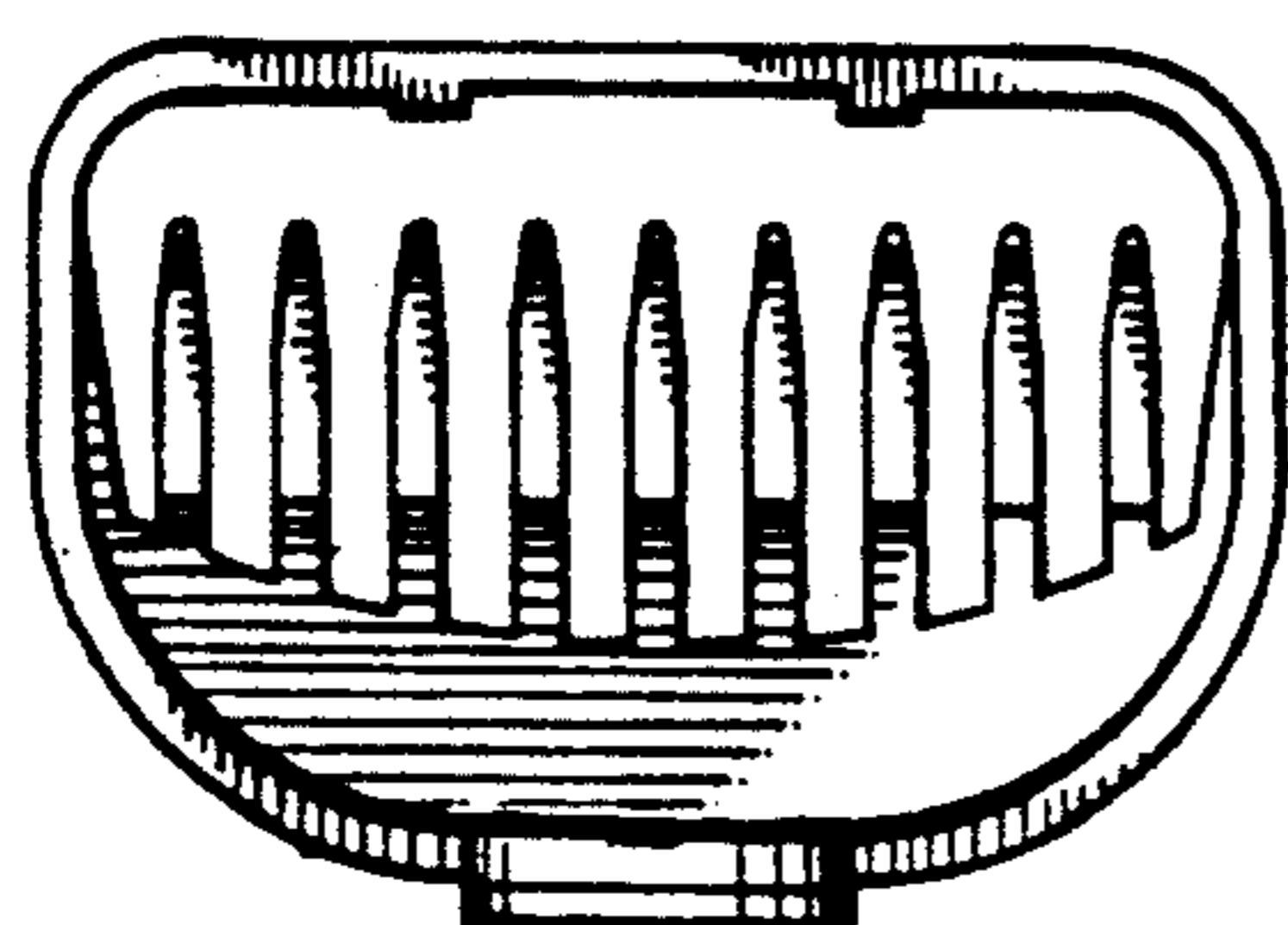

FIG. 13

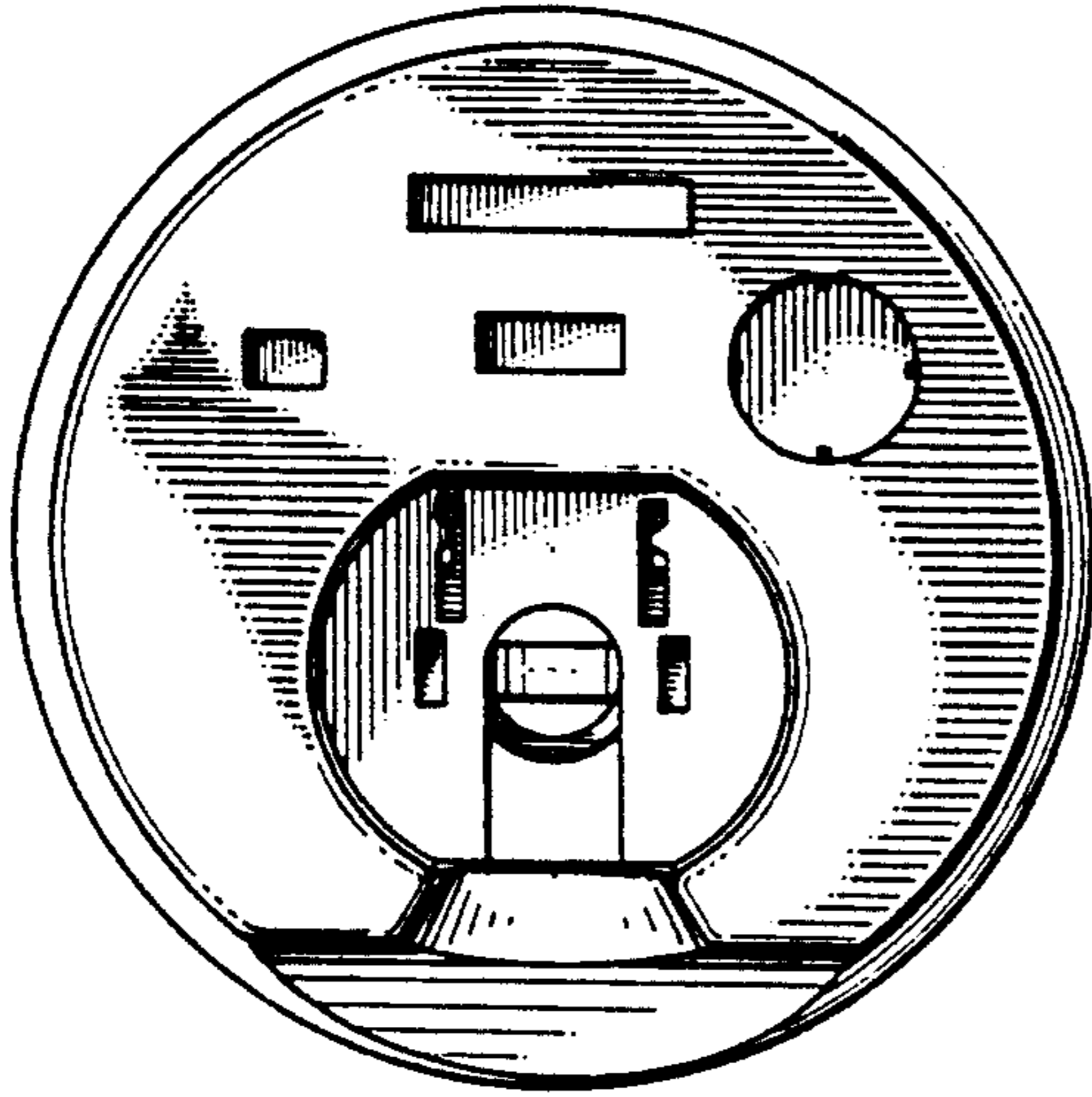

FIG. 14

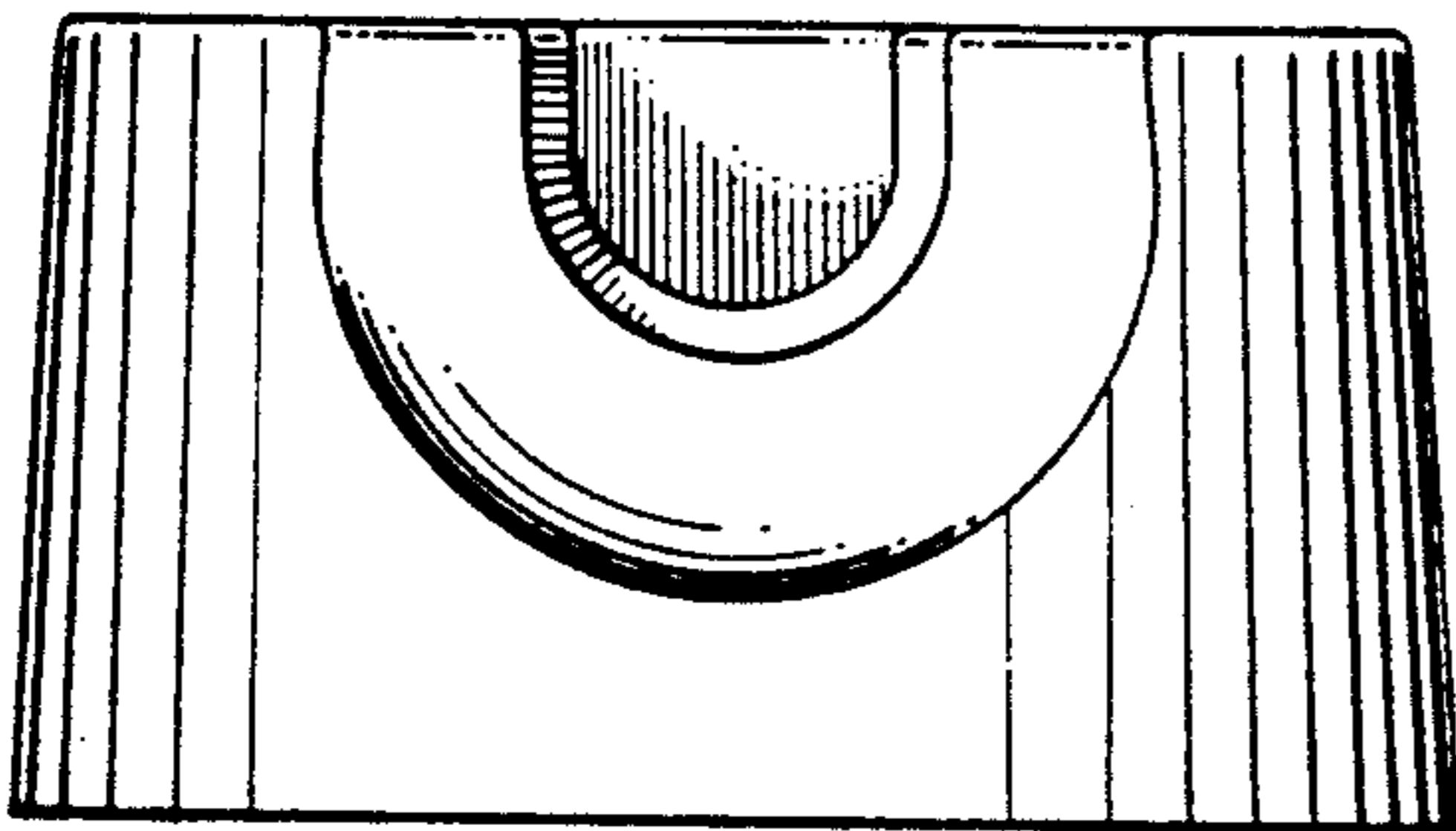

FIG. 15

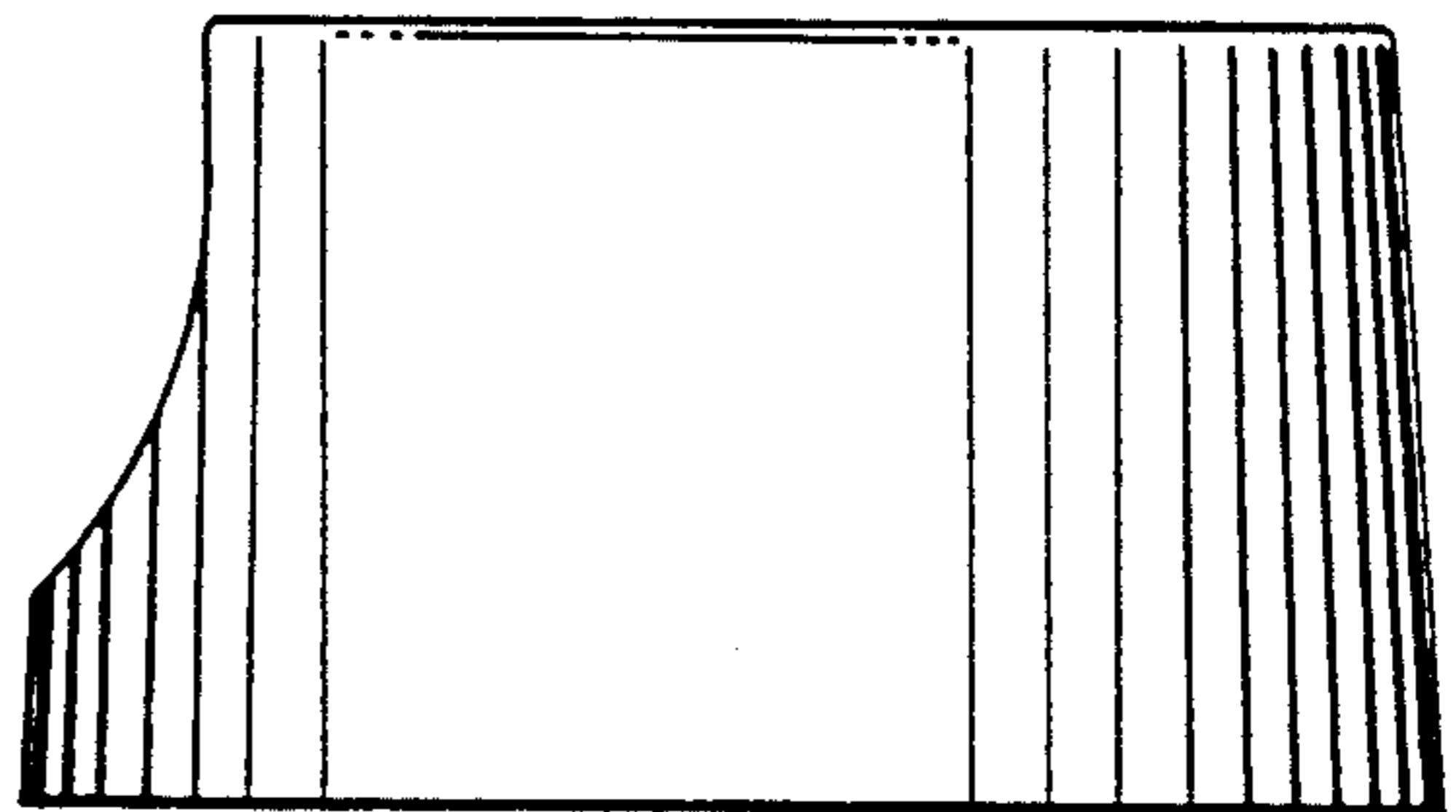

FIG. 16

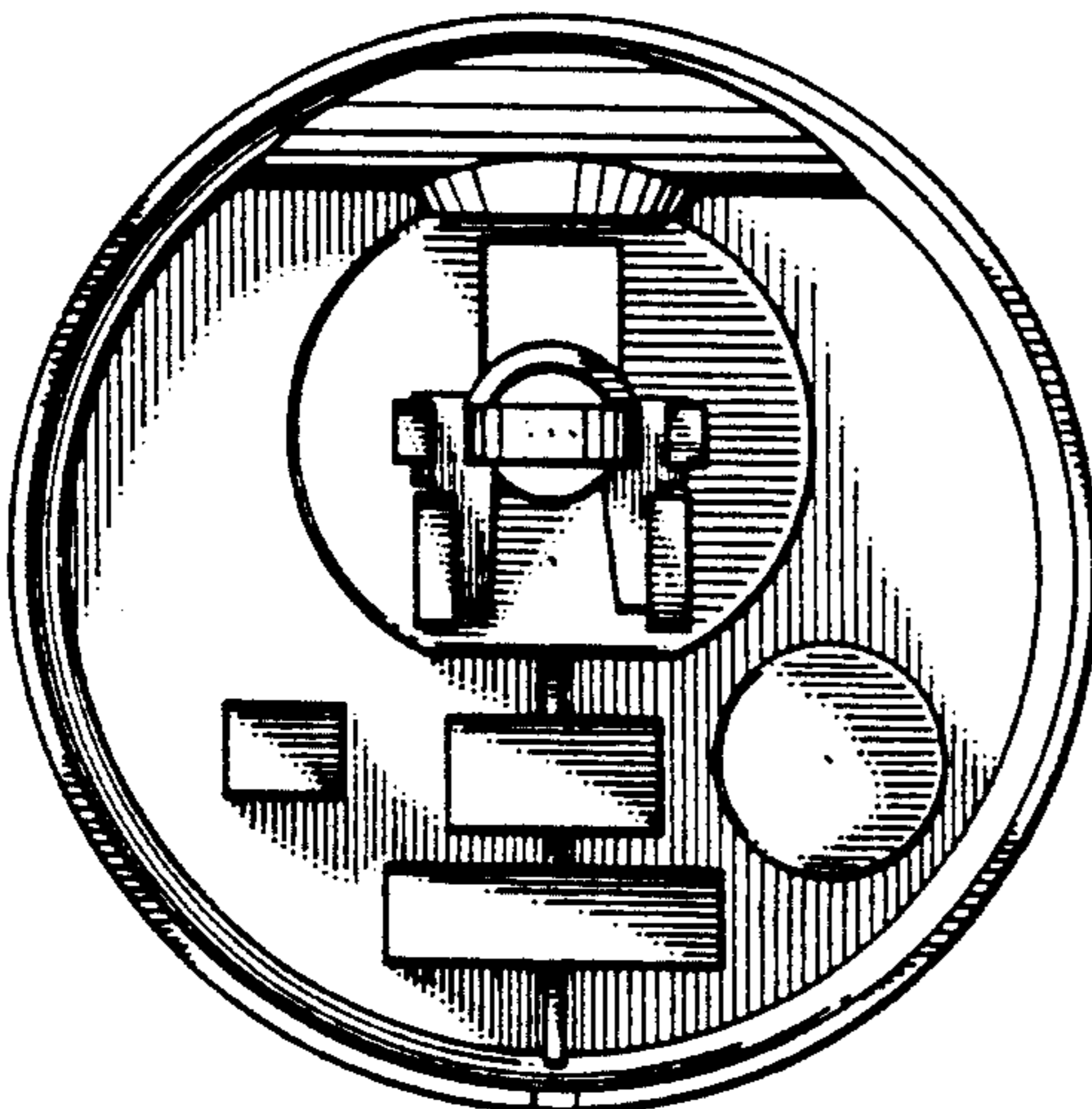

FIG. 17

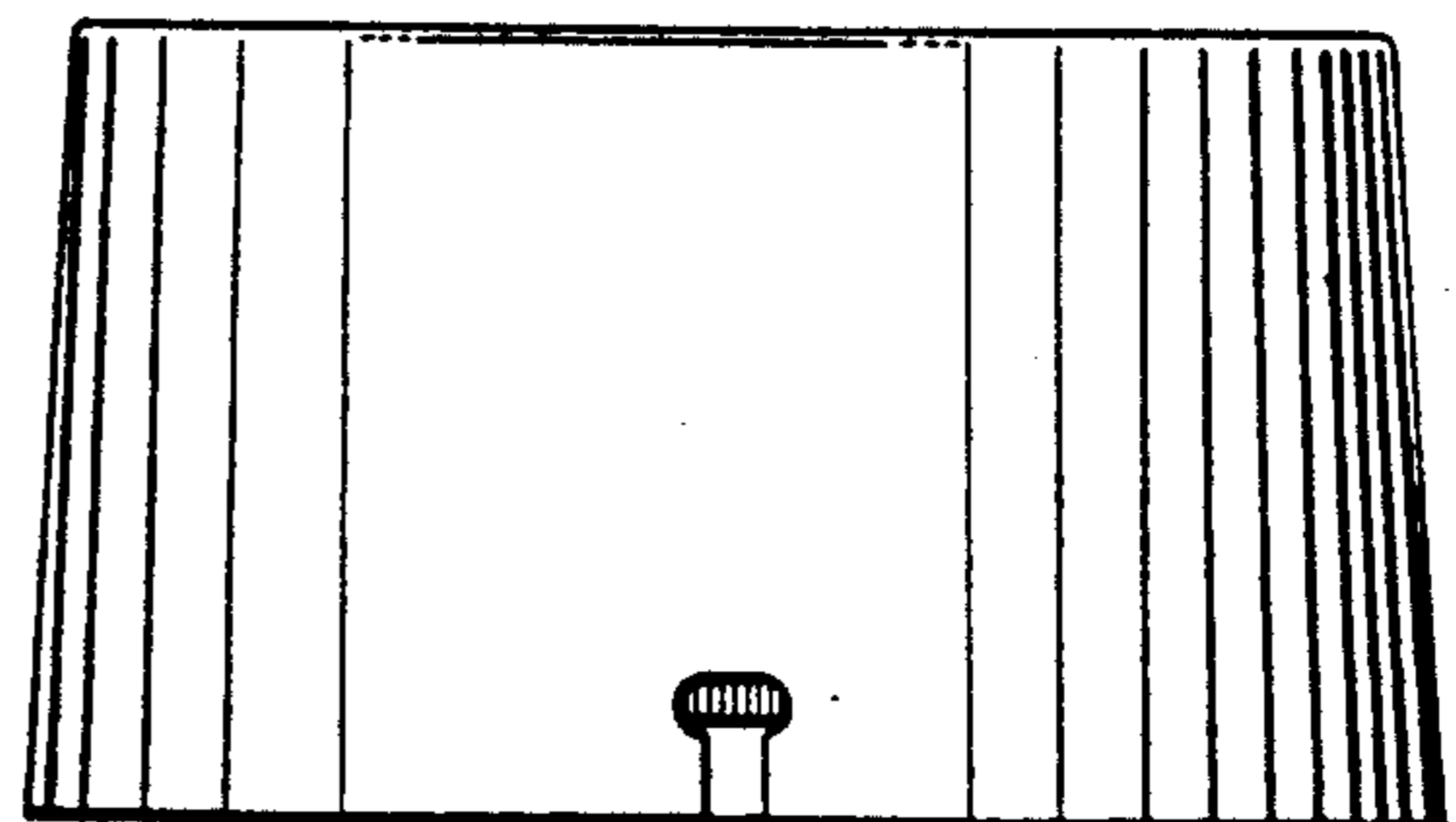

FIG. 18

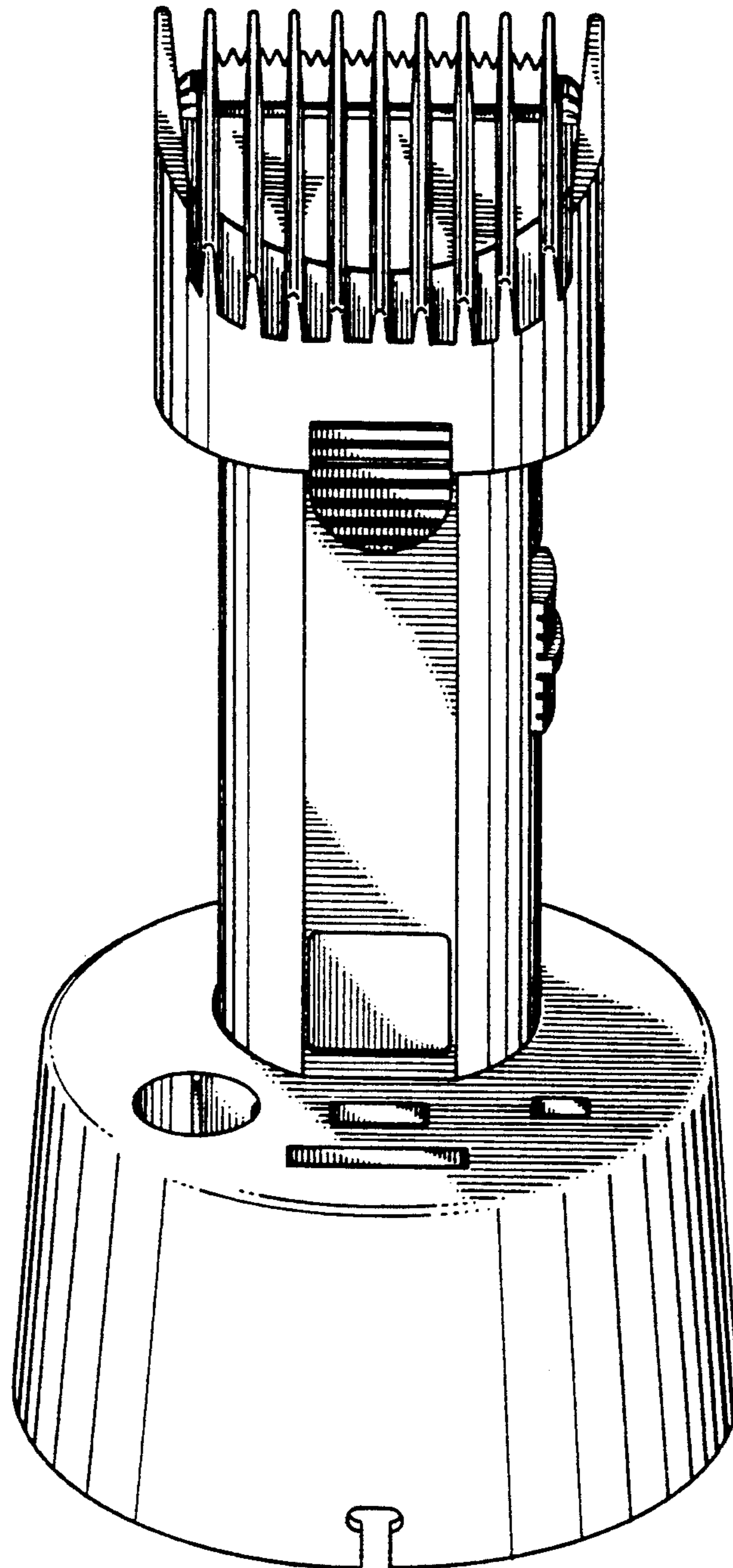

FIG. 19

