



US00D339649S

United States Patent [19]

[11] Patent Number: Des. 339,649

Klossner

[45] Date of Patent: ** Sep. 21, 1993

[54] ADJUSTABLE LAMP

DESCRIPTION

- [75] Inventor: **Jeffrey C. Klossner**, Hacienda Heights, Calif.
- [73] Assignee: **Grandrich Corp.**, Santa Fe Springs, Calif.
- [**] Term: **14 Years**
- [21] Appl. No.: **775,235**
- [22] Filed: **Oct. 10, 1991**
- [52] U.S. Cl. **D26/63**
- [58] Field of Search **D26/61-66;**
362/269, 275, 410, 413, 414, 418, 419, 427

FIG. 1 is an isometric view of a adjustable lamp showing my new design;
 FIG. 2 is a front elevational view of the adjustable lamp shown in FIG. 1;
 FIG. 3 is a rear elevational view of the adjustable lamp shown in FIG. 1 a portion of the lamp being fragmentarily shown for convenience of illustration;
 FIG. 4 is a top plan view of the adjustable lamp shown in FIG. 1;
 FIG. 5 is a left side elevational view of the adjustable lamp shown in FIG. 1;
 FIG. 6 is a bottom plan view of the adjustable lamp shown in FIG. 1;
 FIG. 7 is a right side elevational view of the adjustable lamp shown in FIG. 1;
 FIG. 8 is an isometric view of another embodiment of a adjustable lamp shown my new design;
 FIG. 9 is a front elevational view of the lamp shown in FIG. 8;
 FIG. 10 is a rear elevational view of the lamp shown in FIG. 8 a portion of the lamp being fragmentarily shown for convenience of illustration;
 FIG. 11 is a top plan view of the lamp shown in FIG. 8;
 FIG. 12 is a left side elevational view of the lamp shown in FIG. 8;
 FIG. 13 is a bottom plan view of the lamp shown in FIG. 8; and,
 FIG. 14 is a right side elevational view of the lamp shown in FIG. 8.

[56] References Cited

U.S. PATENT DOCUMENTS

- D. 286,082 10/1986 Shwisha D26/61
- D. 301,633 6/1989 Shwisha D26/63

Primary Examiner—Susan J. Lucas
Attorney, Agent, or Firm—Nilsson, Wurst & Green

[57] CLAIM

The ornamental design for an adjustable lamp, as shown and described.

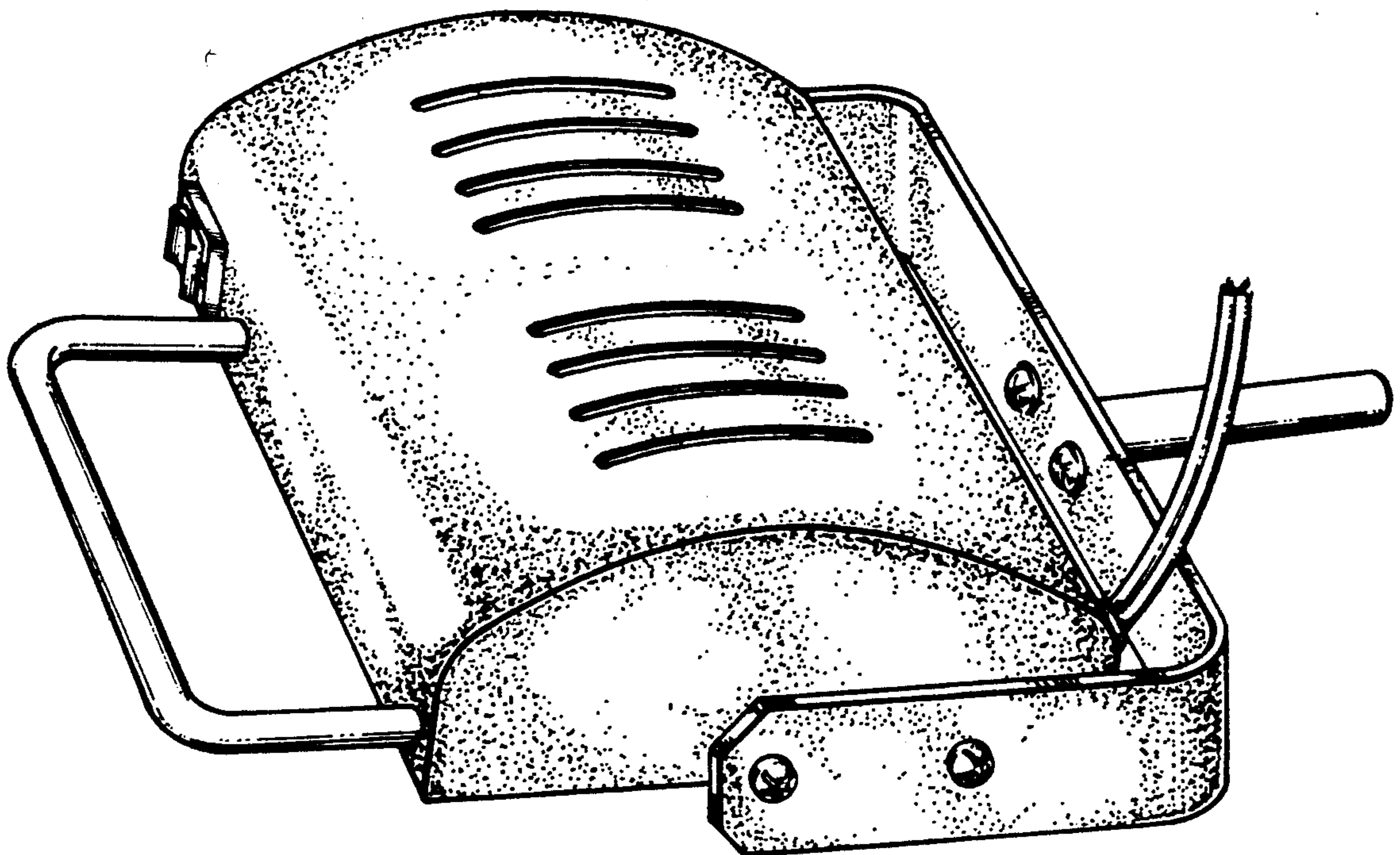

FIG. 1

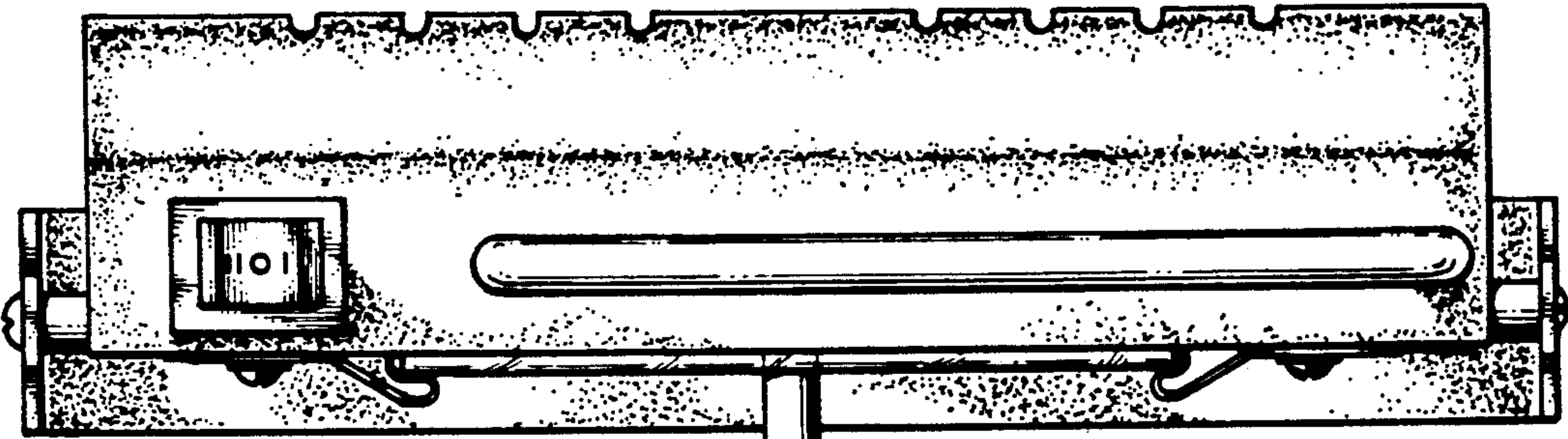
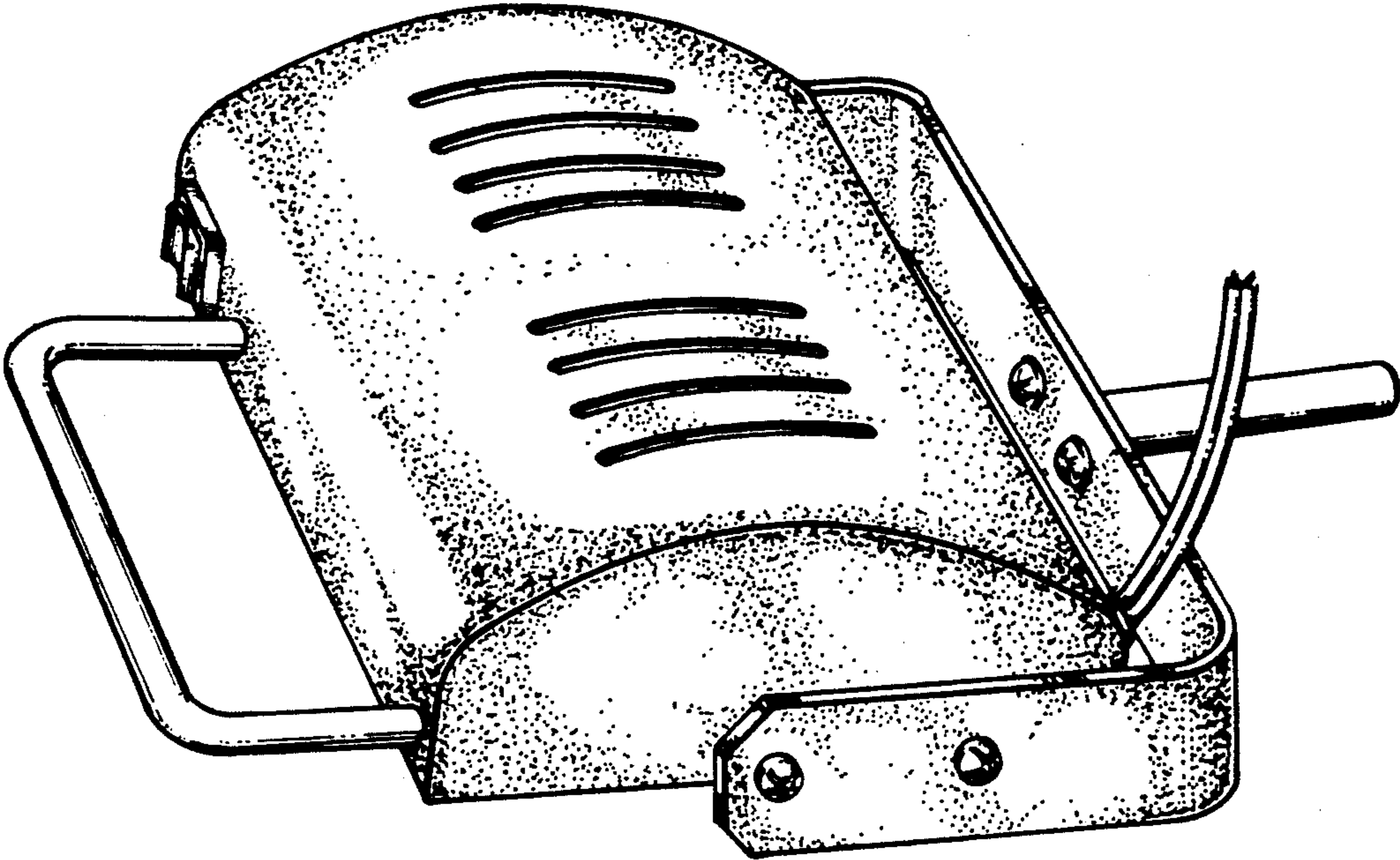

FIG. 2

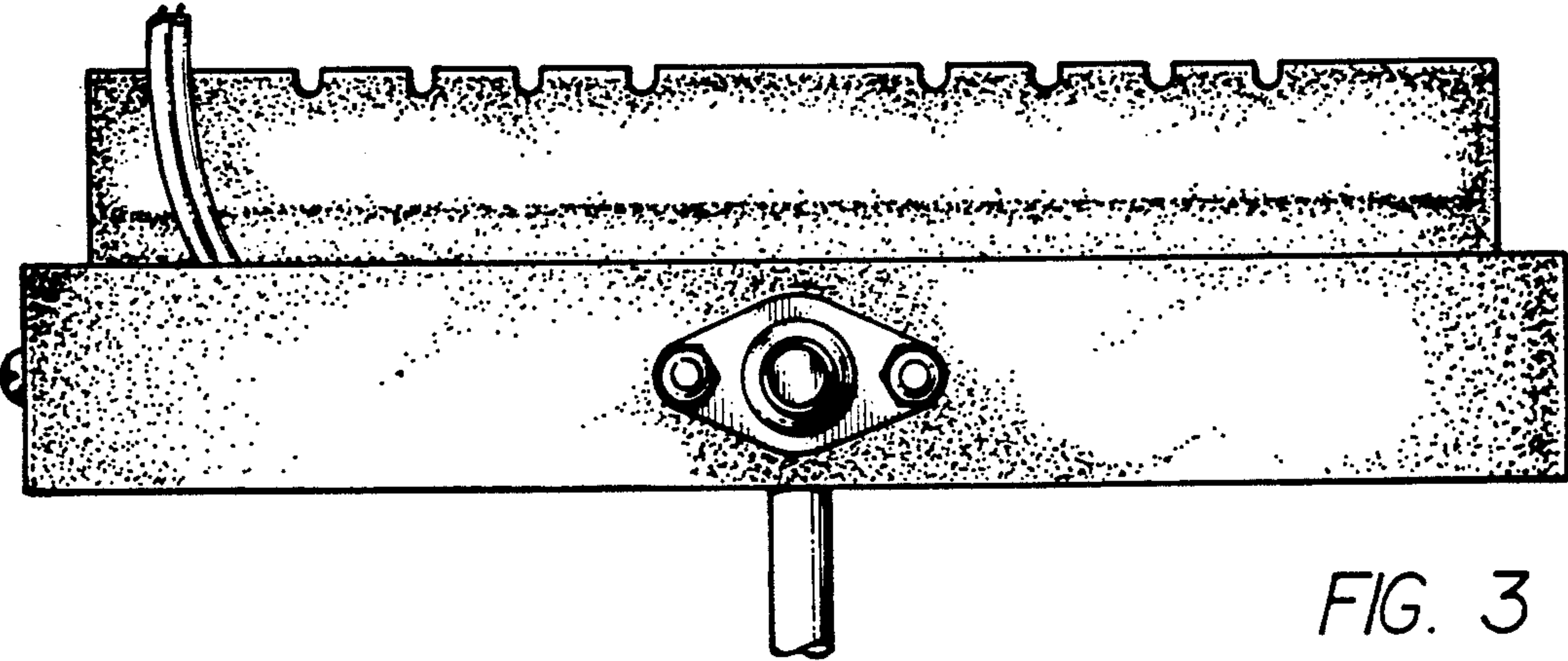

FIG. 3

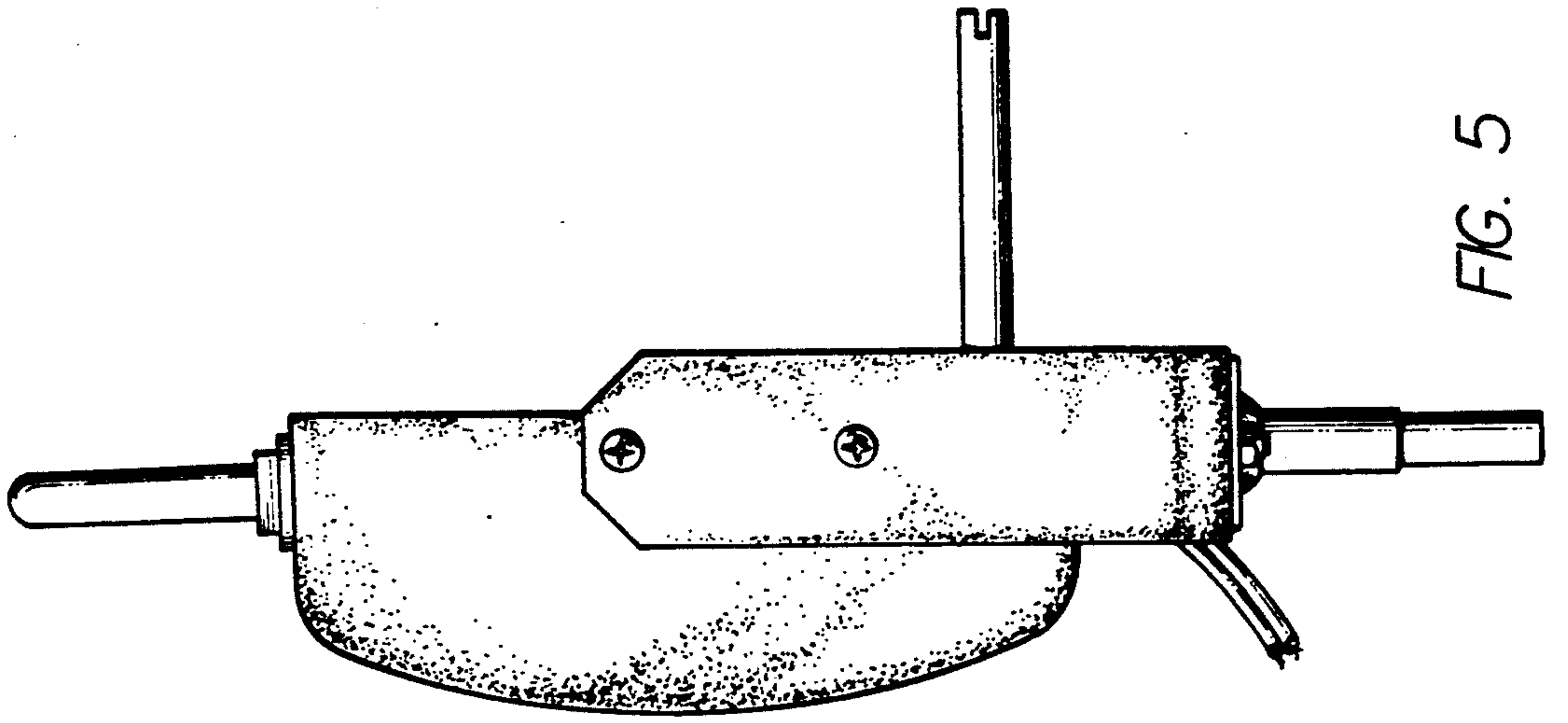

FIG. 5

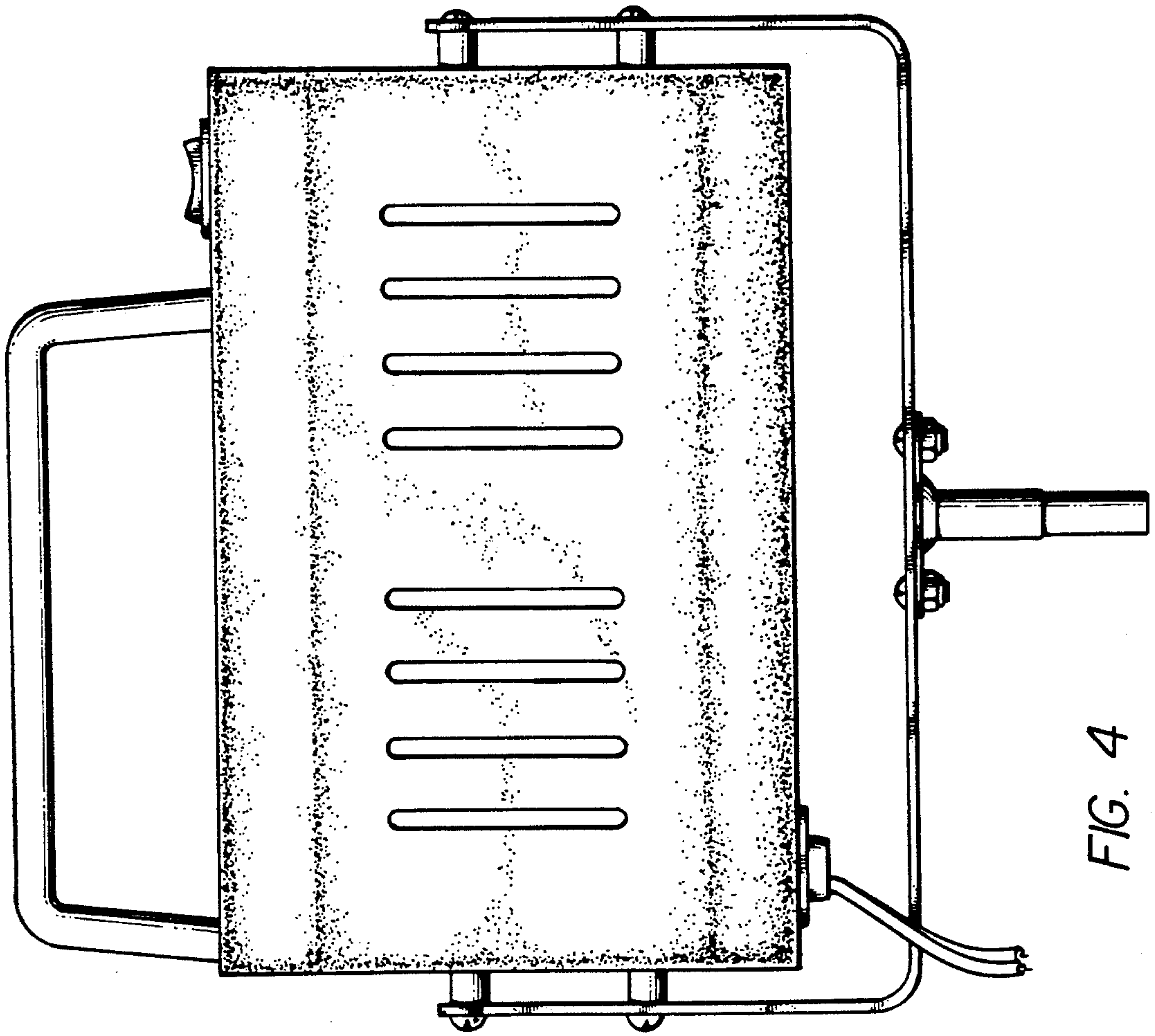

FIG. 4

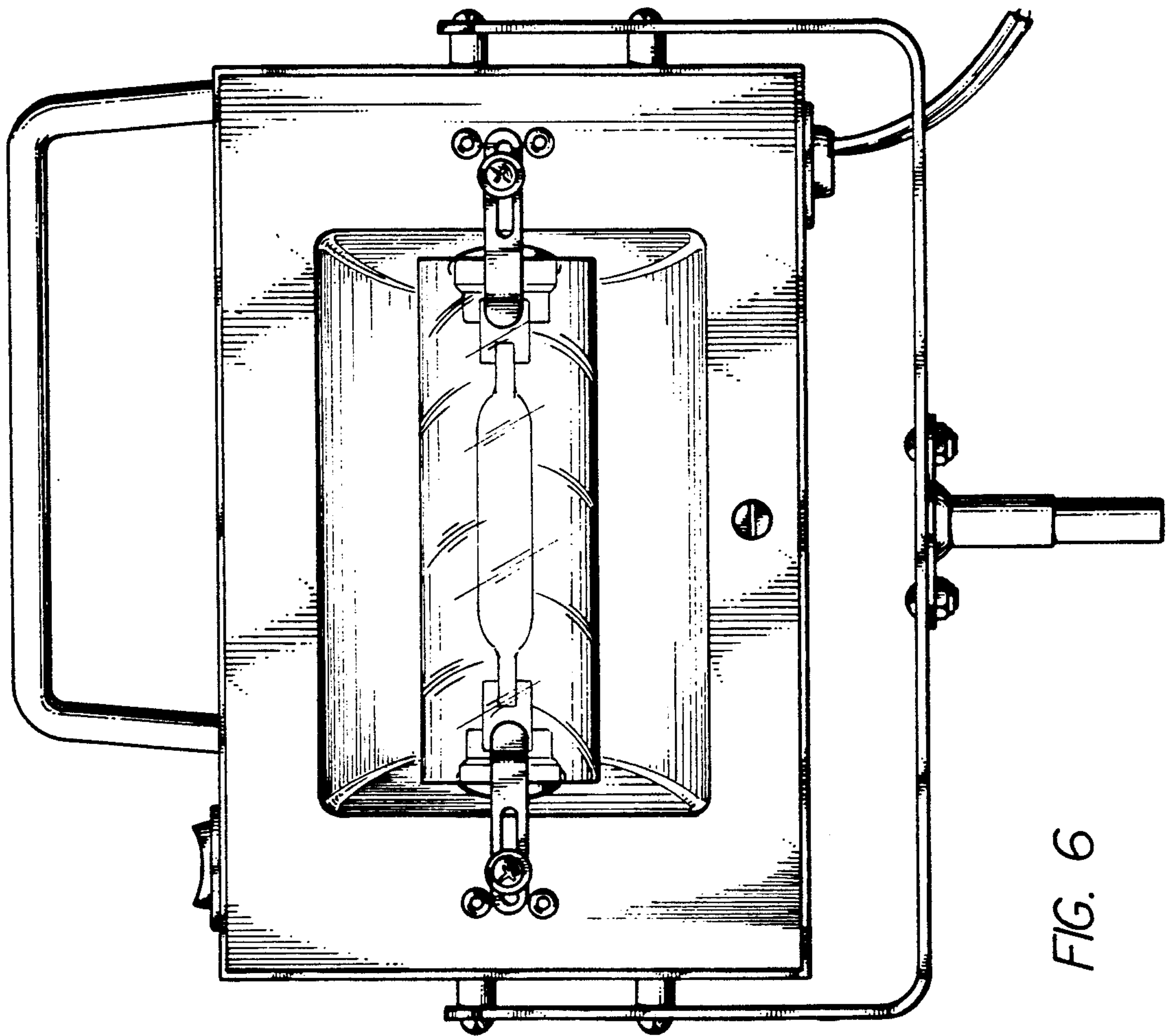
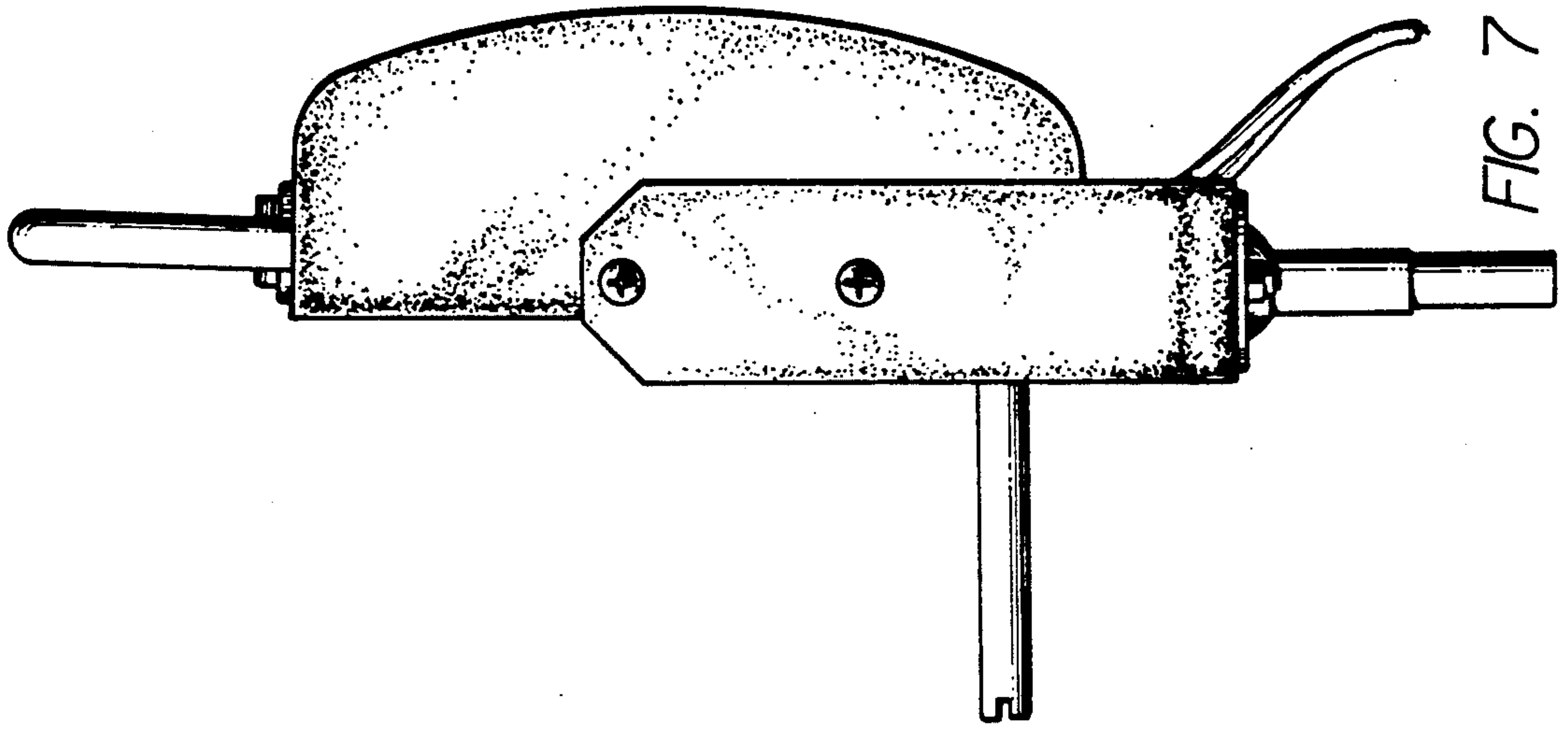

FIG. 8

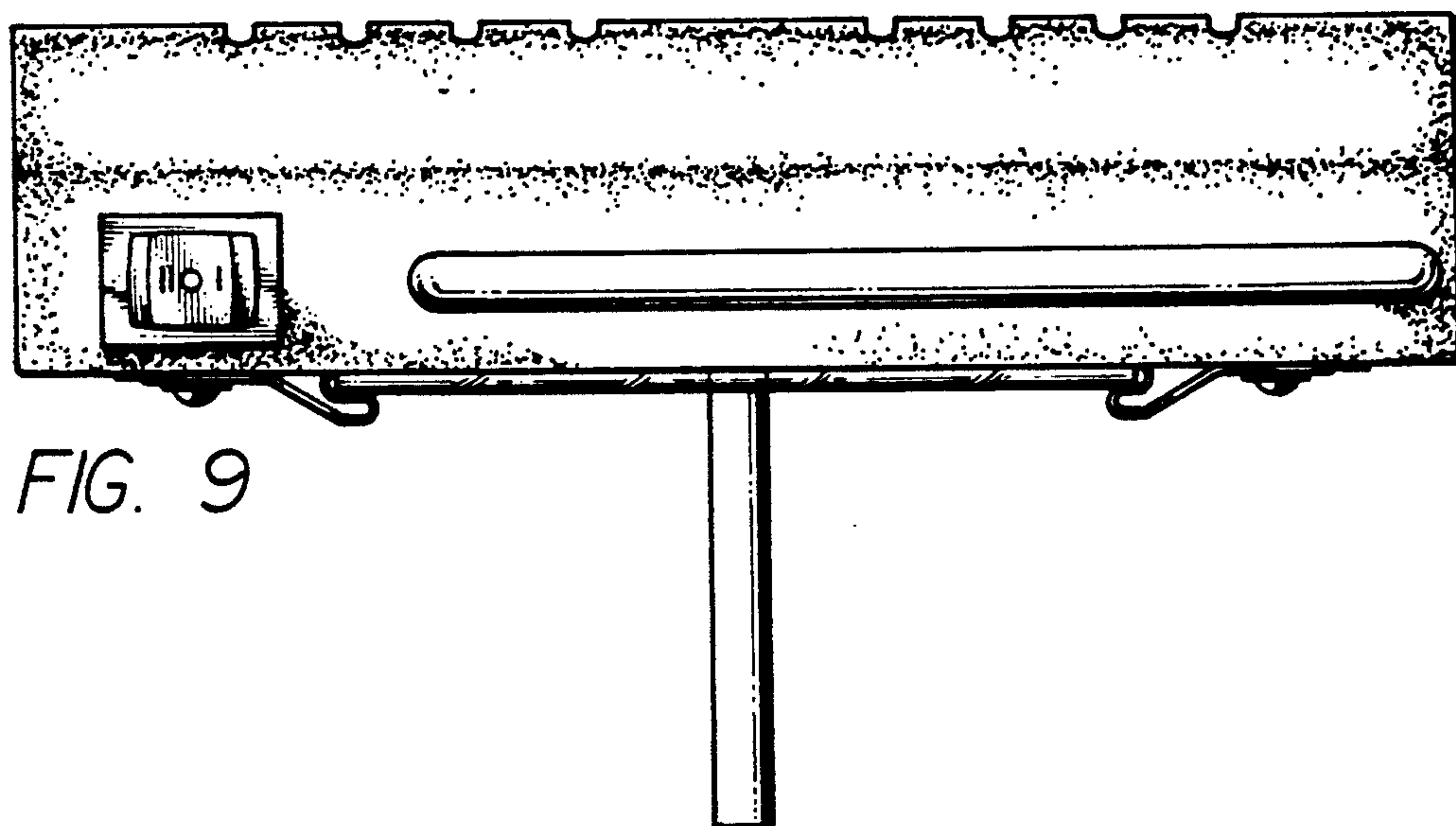
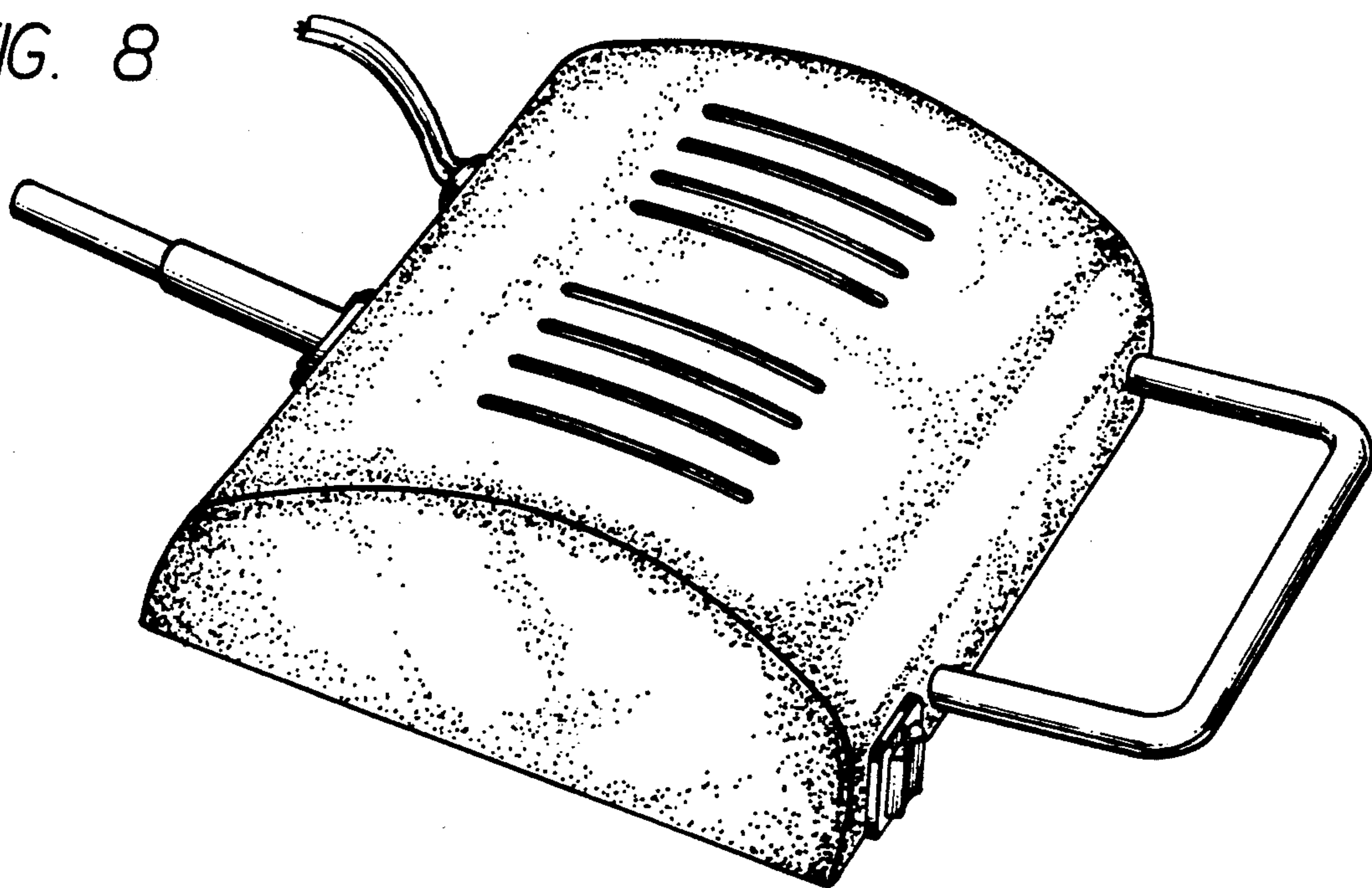

FIG. 9

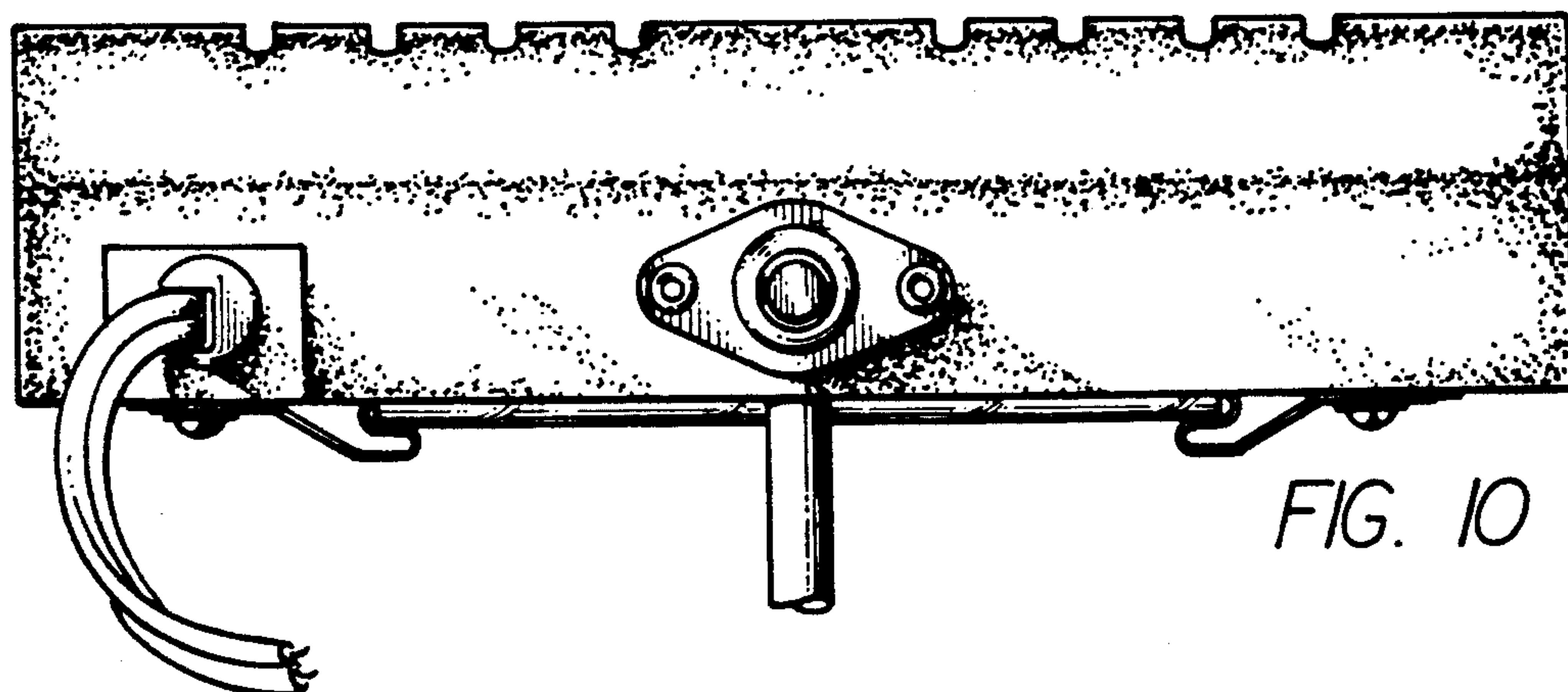

FIG. 10

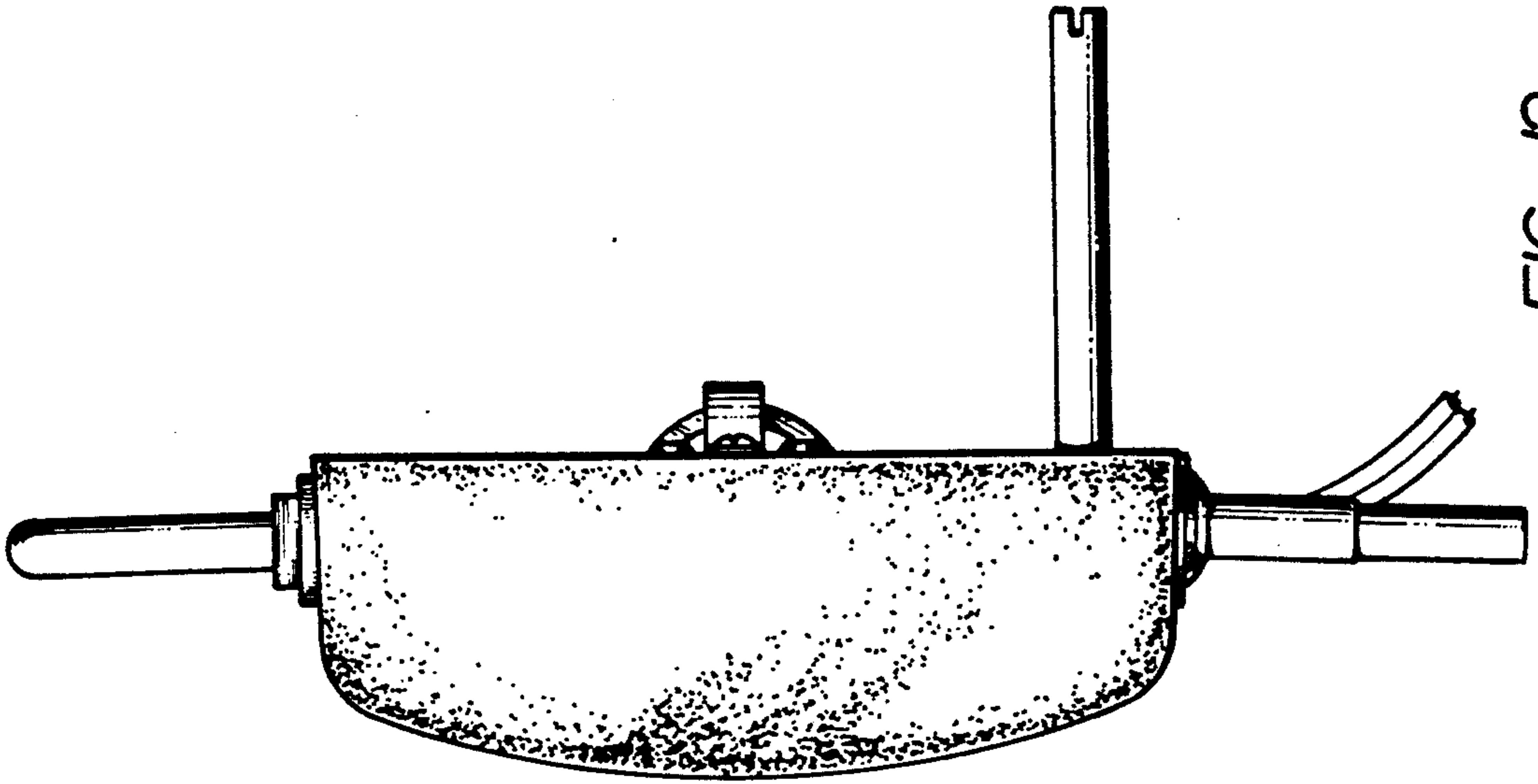

FIG. 12

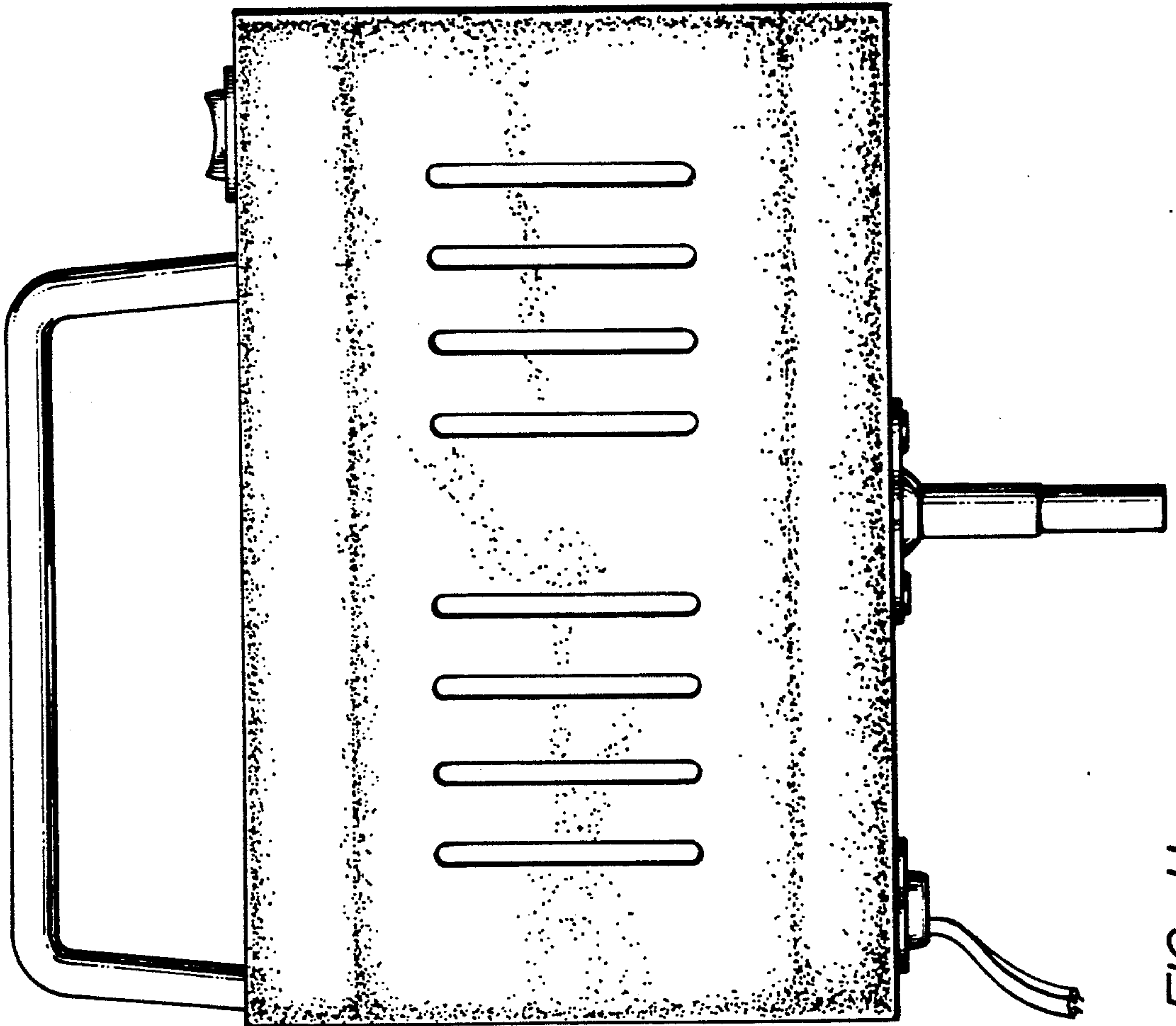

FIG. 11

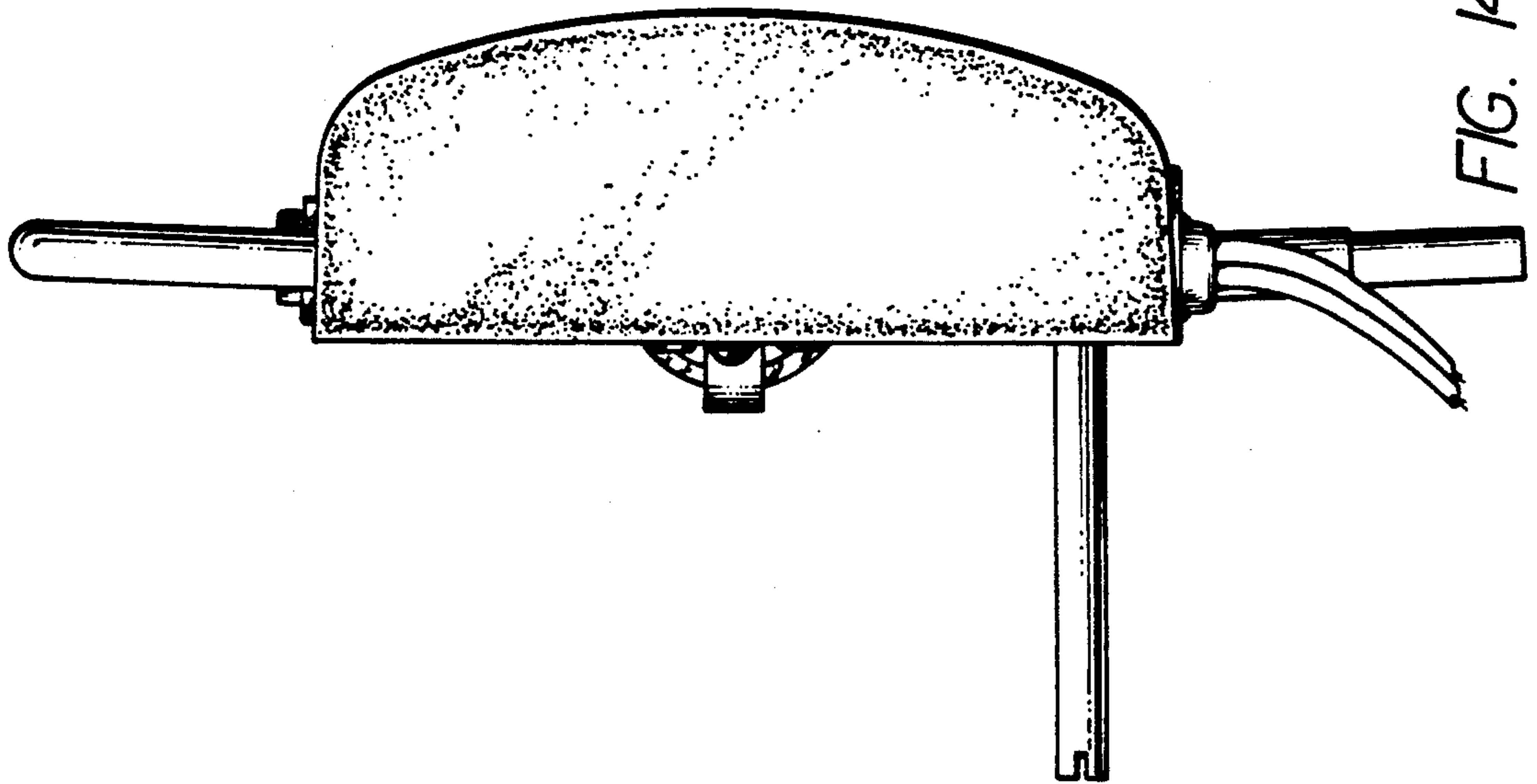

FIG. 14

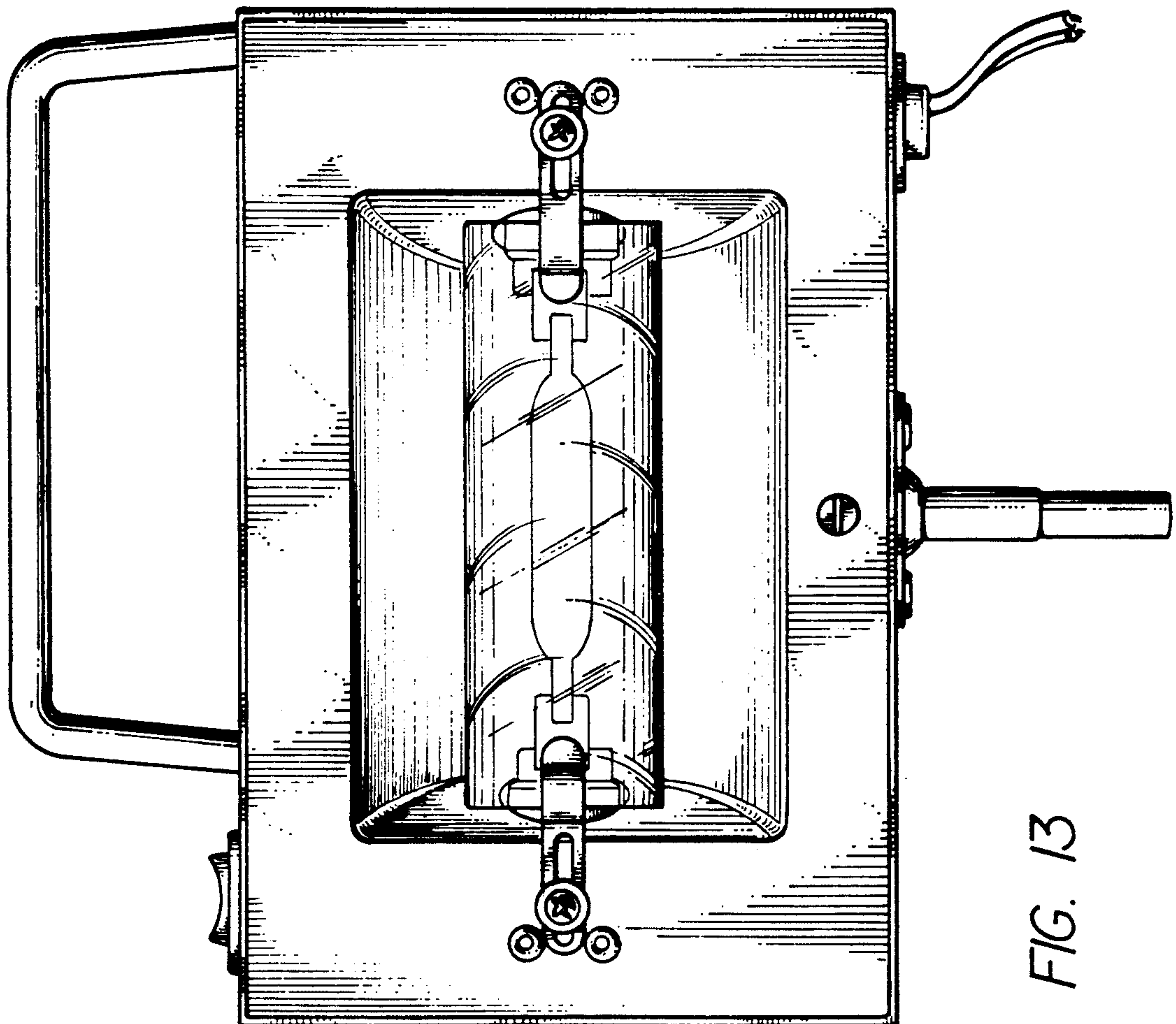

FIG. 13