



US00D339587S

United States Patent [19]

[11] Patent Number: **Des. 339,587**

Ito et al.

[45] Date of Patent: **** Sep. 21, 1993**

[54] **COMBINED DIGITAL AUDIO DISK PLAYER AND TAPE RECORDER**

D. 317,308 6/1991 Aoki et al. D14/168
D. 327,684 7/1992 Totsuka D14/168

[75] Inventors: **Masafumi Ito, Tokyo; Minoru Sube, Hachioji; Haruki Takita, Tokyo; Hiroyuki Watanabe, Oume; Yukio Iikura, Aska, all of Japan**

OTHER PUBLICATIONS

HFD, May 23, 1988, p. 97, Quasar Compact Stereo.
JVC brochure for MEZZO A3, published Sep., 1990.

[73] Assignee: **TEAC Corporation, Japan**

Primary Examiner—Theodore M. Shooman
Attorney, Agent, or Firm—Andrus, Scales, Starke & Sawall

[**] Term: **14 Years**

[21] Appl. No.: **812,357**

[57] CLAIM

The ornamental design for a combined digital audio disk player and tape recorder, as shown and described.

[22] Filed: **Dec. 20, 1991**

[30] Foreign Application Priority Data

Jun. 21, 1991 [JP] Japan 3-18522

DESCRIPTION

[52] U.S. Cl. **D14/168**

[58] Field of Search D14/124, 156, 160, 164-165,
D14/168-171, 188, 192-195, 197-198, 299;
455/344, 350-351

FIG. 1 is a front view of a combined digital audio disk player and tape recorder showing our new design;
FIG. 2 is a plan view thereof;
FIG. 3 is a right side view thereof;
FIG. 4 is a left side view thereof;
FIG. 5 is a rear view thereof;
FIG. 6 is a bottom view thereof;
FIG. 7 is section view taken along the line A—A of FIG. 1; and,
FIG. 8 is a perspective view thereof in a state where the disc tray is extracted and the two cassette lids are opened.

[56] References Cited

U.S. PATENT DOCUMENTS

D. 310,837 9/1990 Takimoto D14/168
D. 313,598 1/1991 Mori D14/168 X
D. 316,715 5/1991 Shibata D14/169

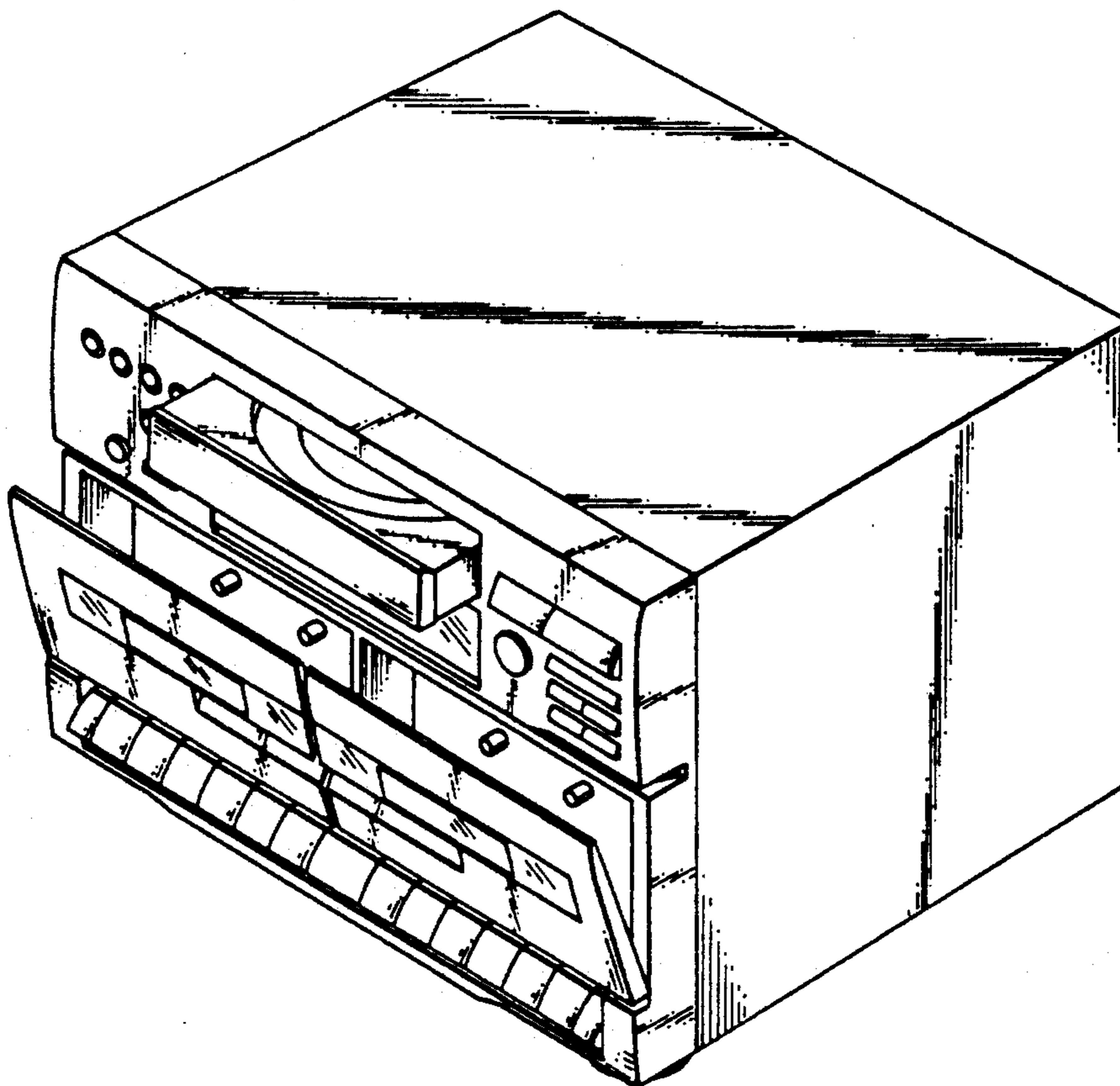
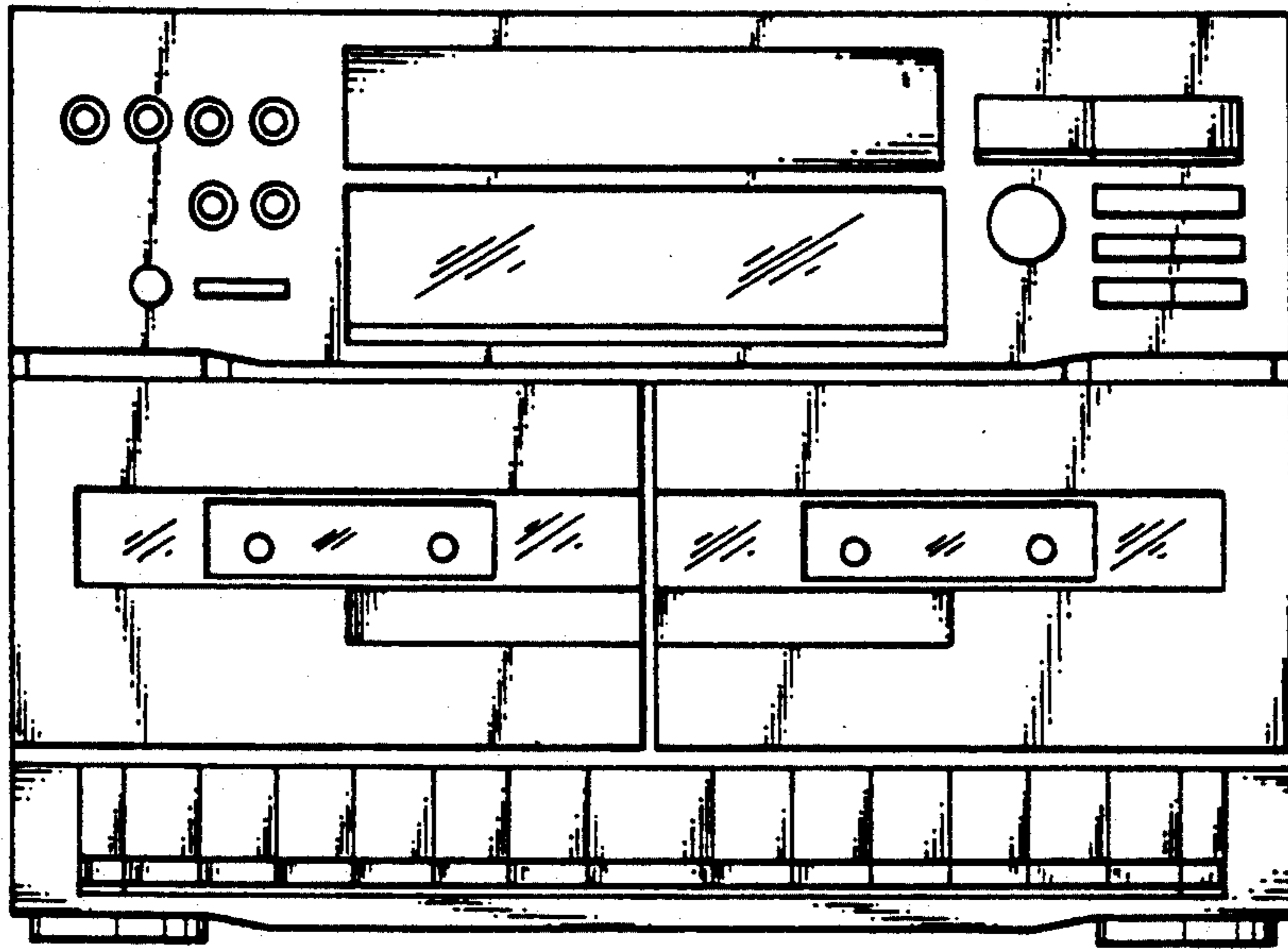

FIG.1

A ↖



A ↖

FIG.2

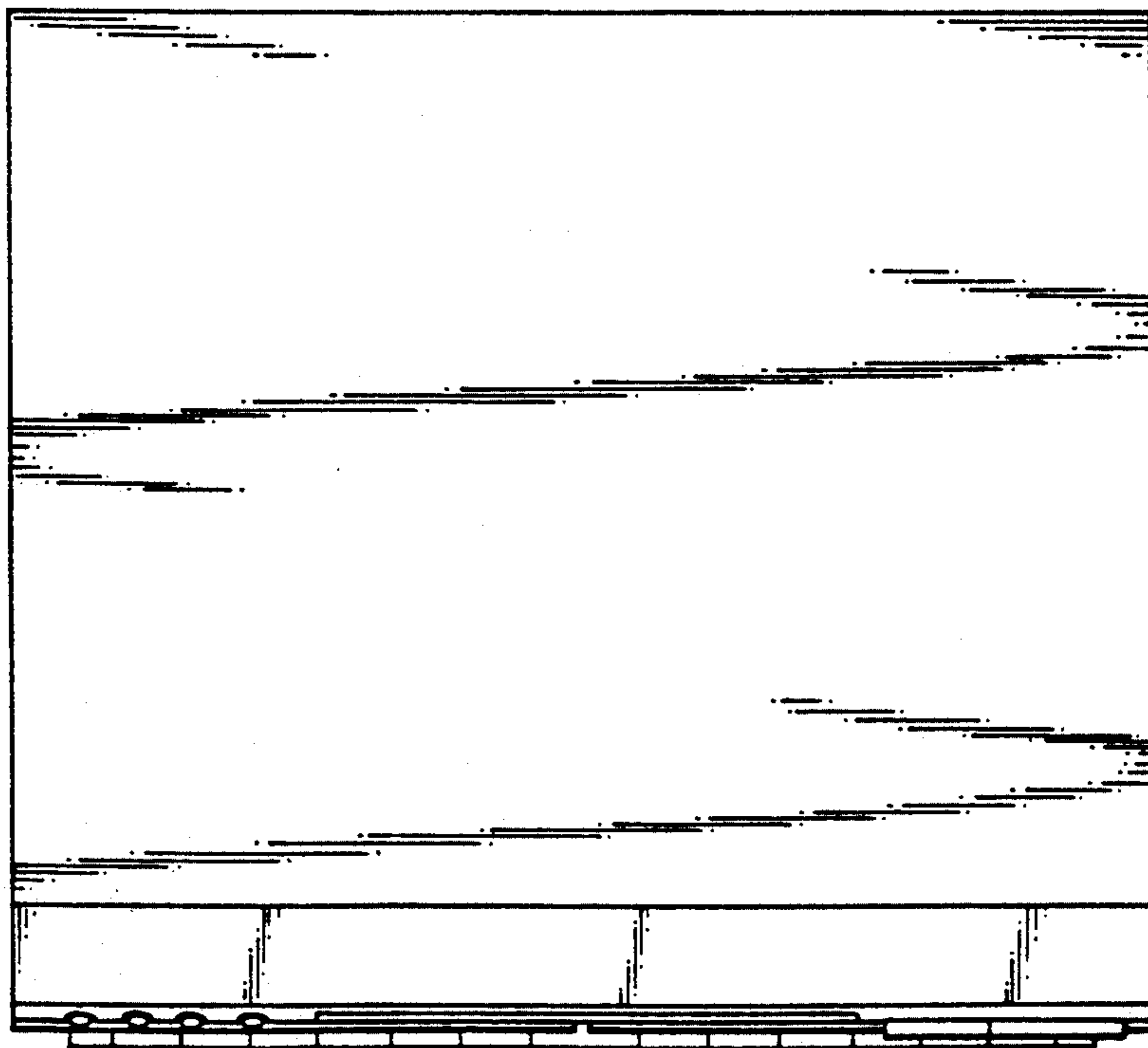

FIG.3

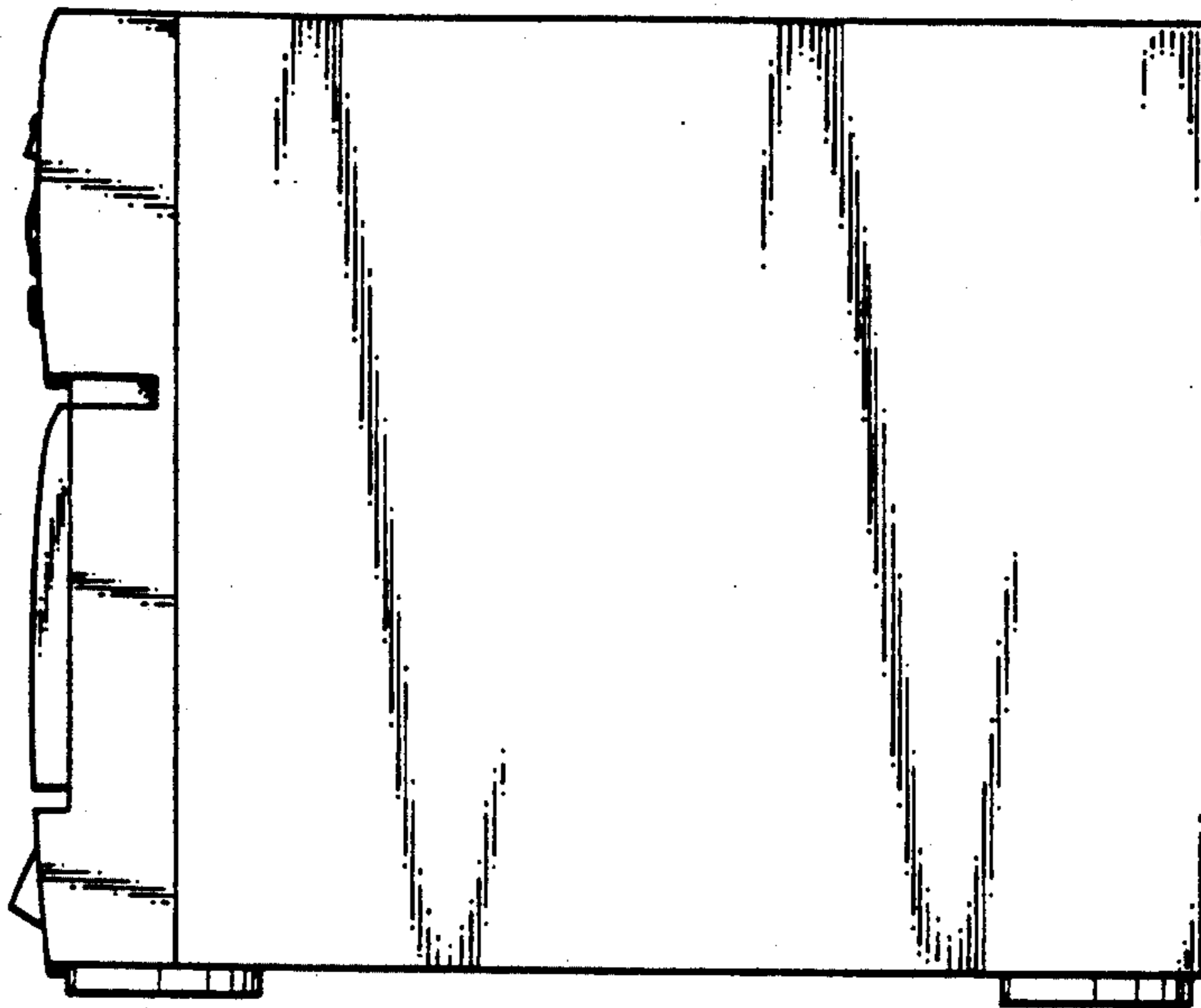

FIG.4

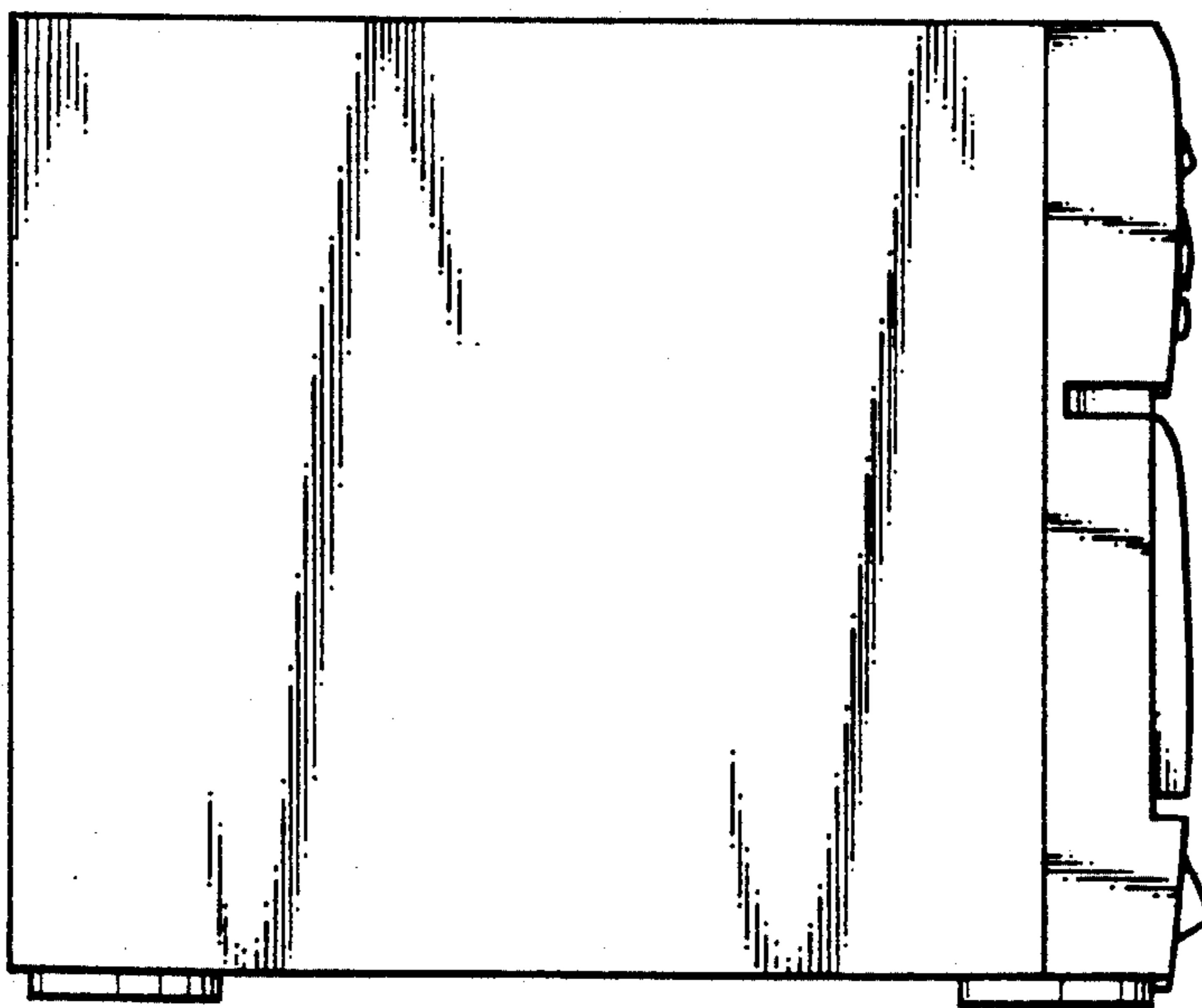

FIG.5

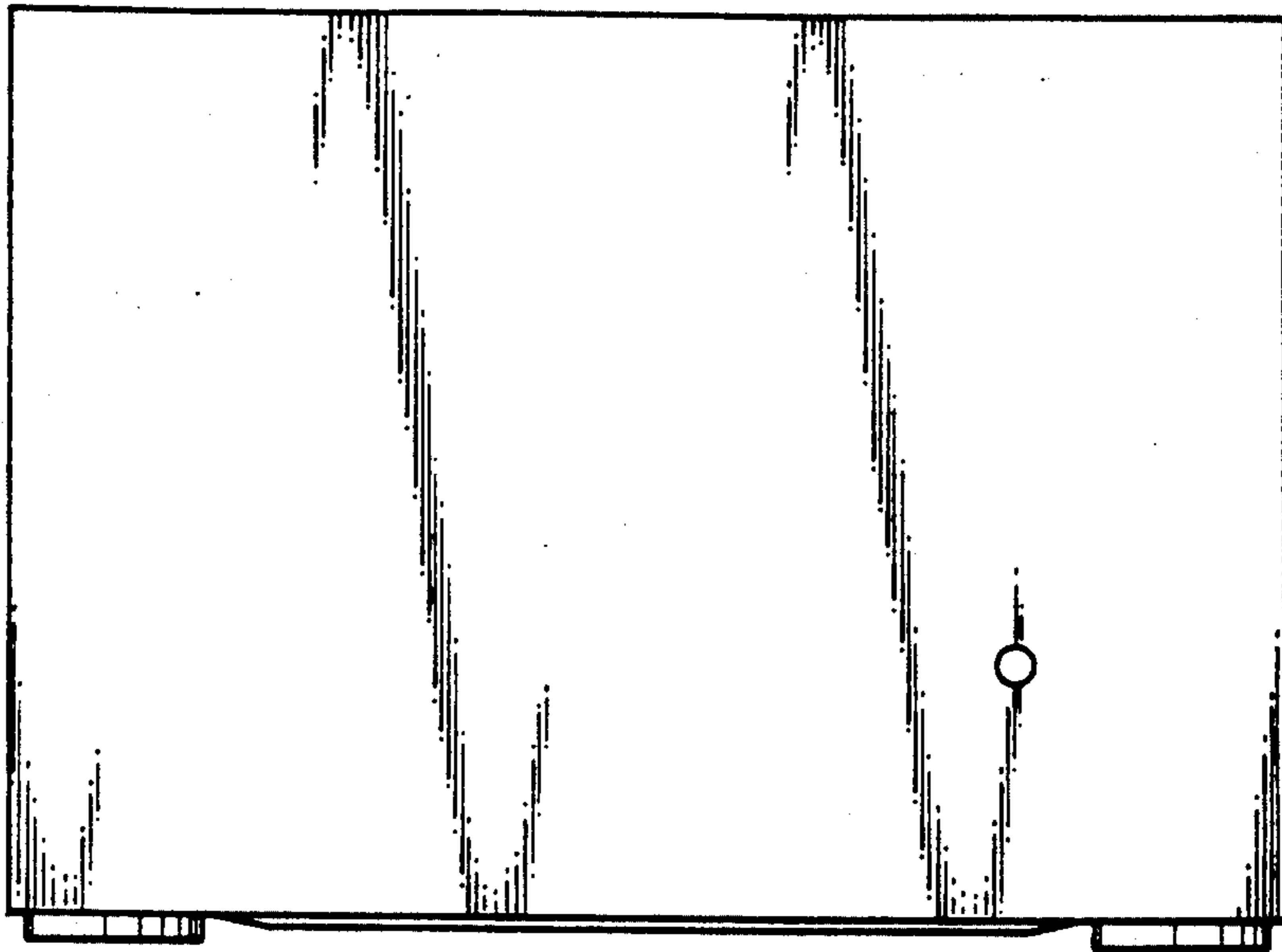

FIG.6

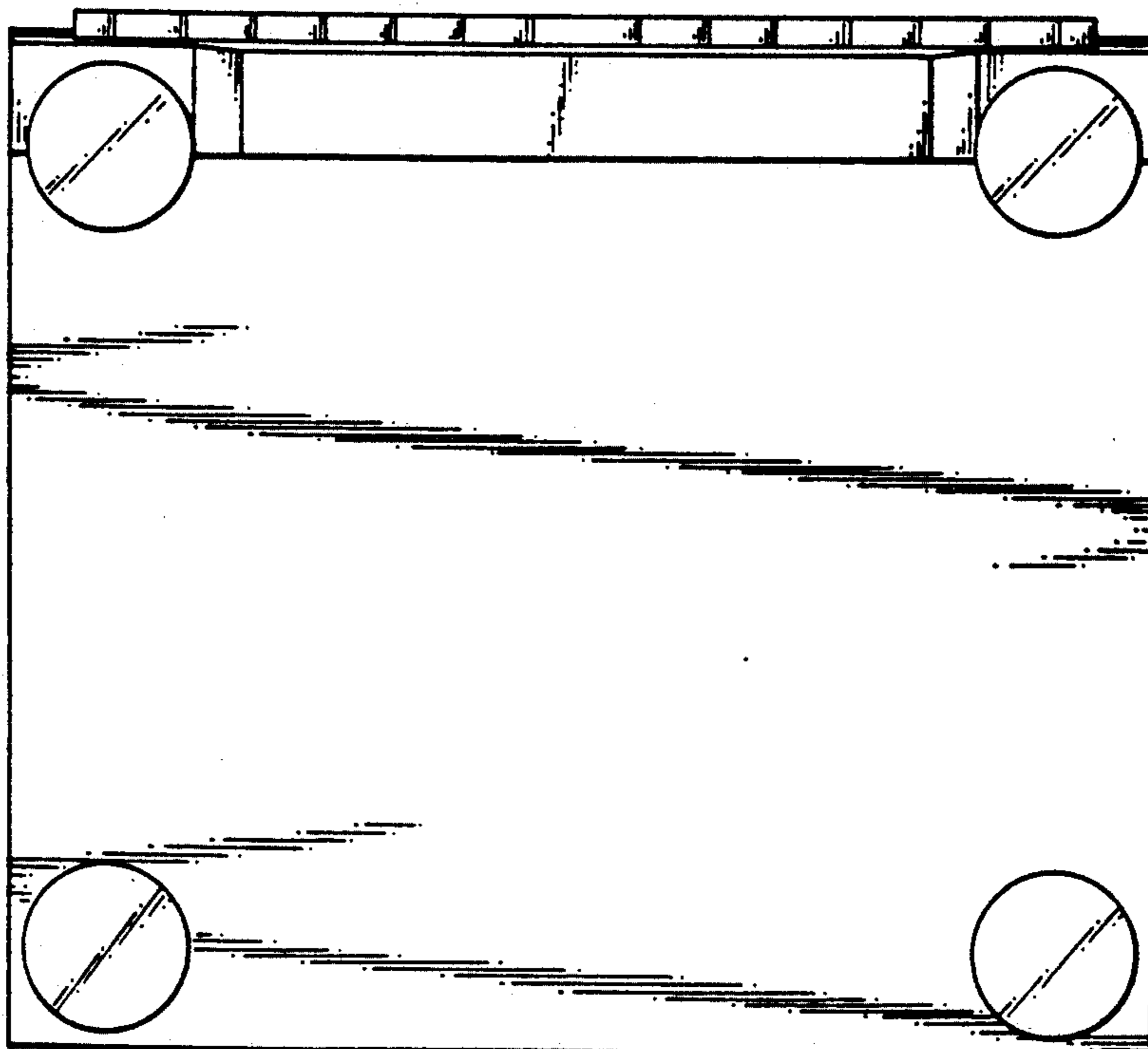

FIG.7

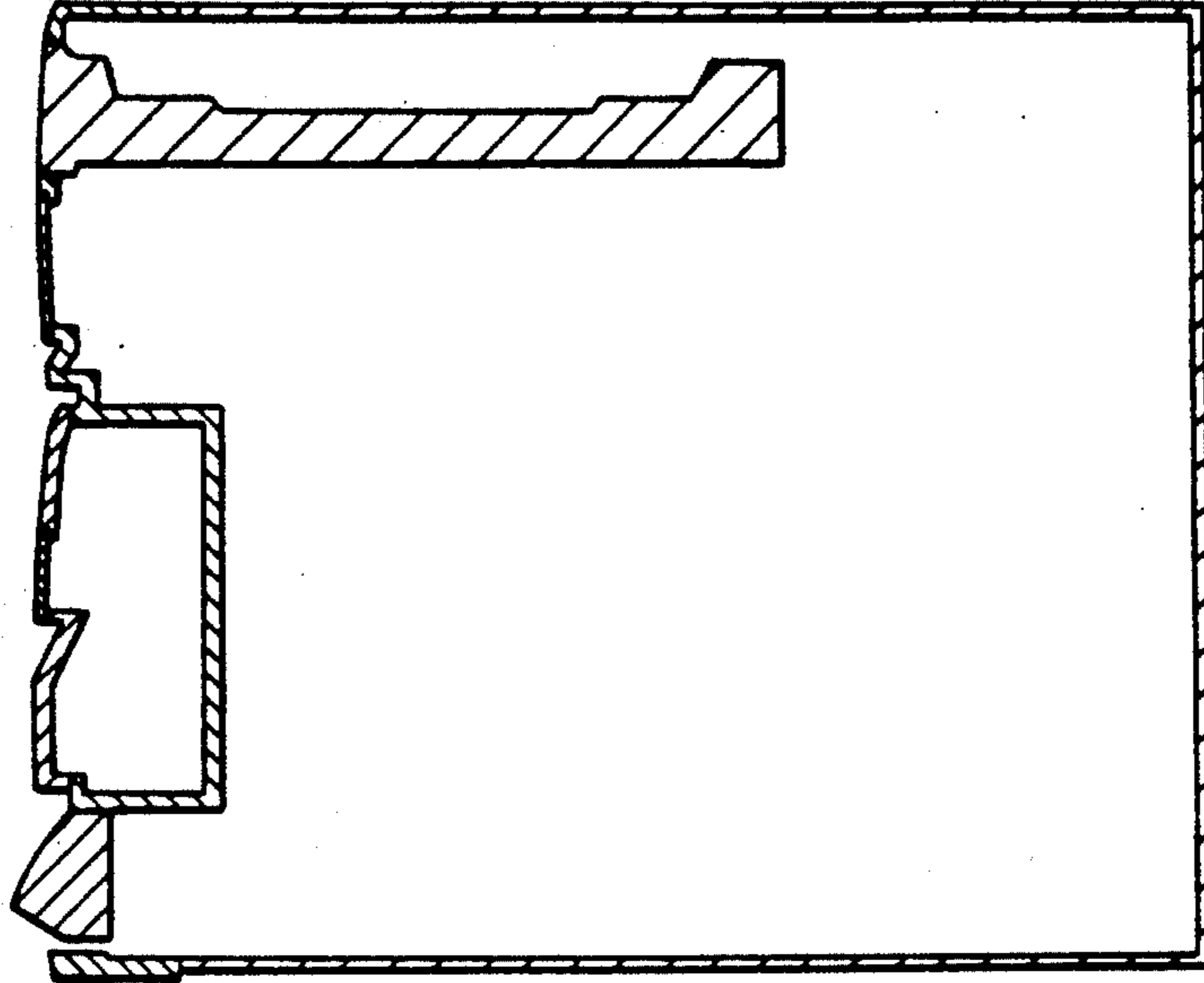

FIG.8

