



US00D339510S

# United States Patent [19]

[11] Patent Number: **Des. 339,510**

**Sakamoto et al.**

[45] Date of Patent: **\*\* Sep. 21, 1993**

[54] **PORTABLE ELECTRIC SAW**

[75] Inventors: **Masakazu Sakamoto; Toshiaki Saito,**  
both of Tokyo, Japan

[73] Assignee: **Ryobi Ltd., Hiroshima, Japan**

[\*\*] Term: **14 Years**

[21] Appl. No.: **793,676**

[22] Filed: **Nov. 18, 1991**

[30] **Foreign Application Priority Data**

May 20, 1991 [JP]	Japan .....	3-14766
[52] U.S. Cl. ....	<b>D8/64; D8/69</b>	
[58] Field of Search .....	<b>D8/64, 61; 30/392, 373,</b>	<b>30/374, 375, 377, 228, 241, 272</b>

[56] **References Cited**

**U.S. PATENT DOCUMENTS**

4,206,657	6/1980	Palm .....	30/392
4,747,212	5/1988	Cavdek .....	30/374
5,007,172	4/1991	Palm .....	30/392

**FOREIGN PATENT DOCUMENTS**

421482	4/1976	Japan .
536420	7/1980	Japan .

*Primary Examiner*—Alan P. Douglas  
*Assistant Examiner*—J. H. Musgrove  
*Attorney, Agent, or Firm*—Sughrue, Mion, Zinn,  
Macpeak & Seas

[57] **CLAIM**

The ornamental design for a portable electric saw, as shown.

**DESCRIPTION**

FIG. 1 is a front, top and right side perspective view of a portable electric saw showing our new design; FIG. 2 is a rear, top and left side perspective view thereof; FIG. 3 is a right side elevational view thereof; FIG. 4 is a left side elevational view thereof; FIG. 5 is a rear elevational view thereof; FIG. 6 is a front elevational view thereof; FIG. 7 is a top plan view thereof; and, FIG. 8 is a bottom plan view thereof.

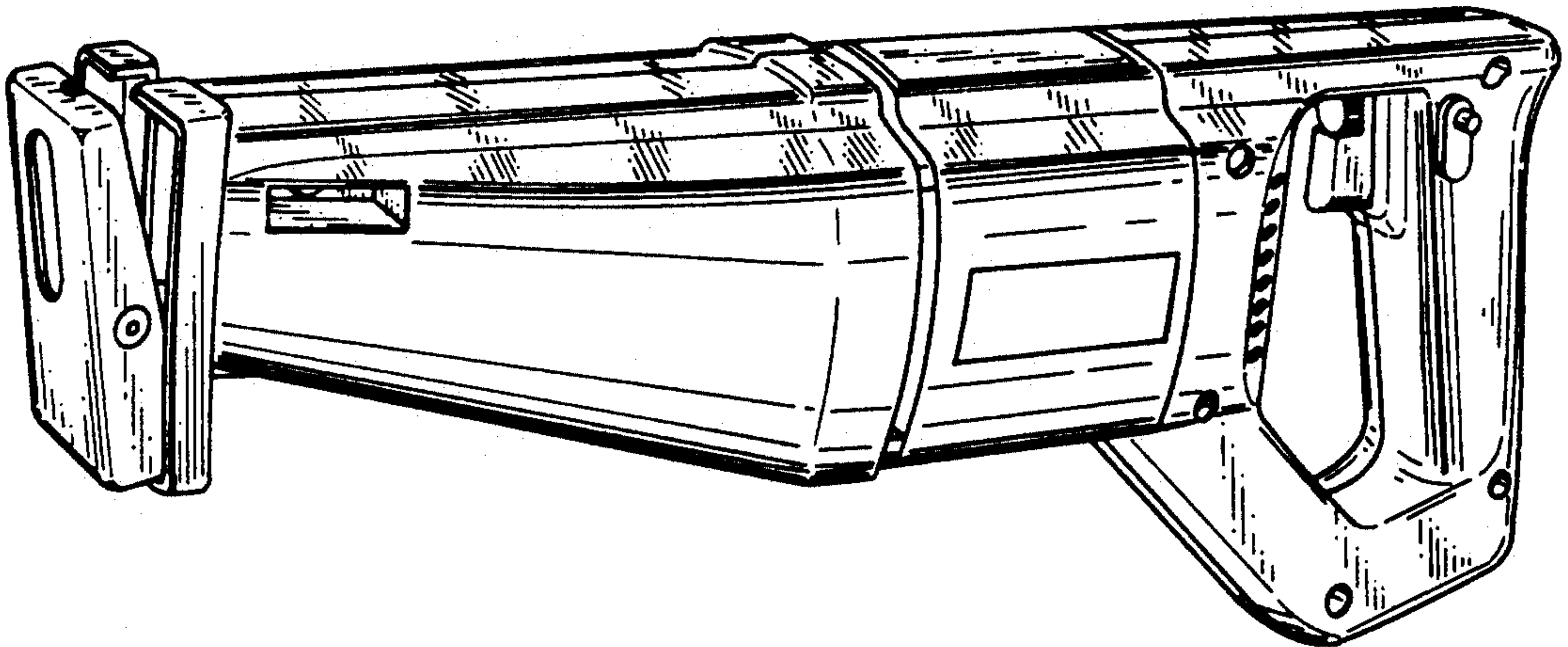

*Fig. 1*

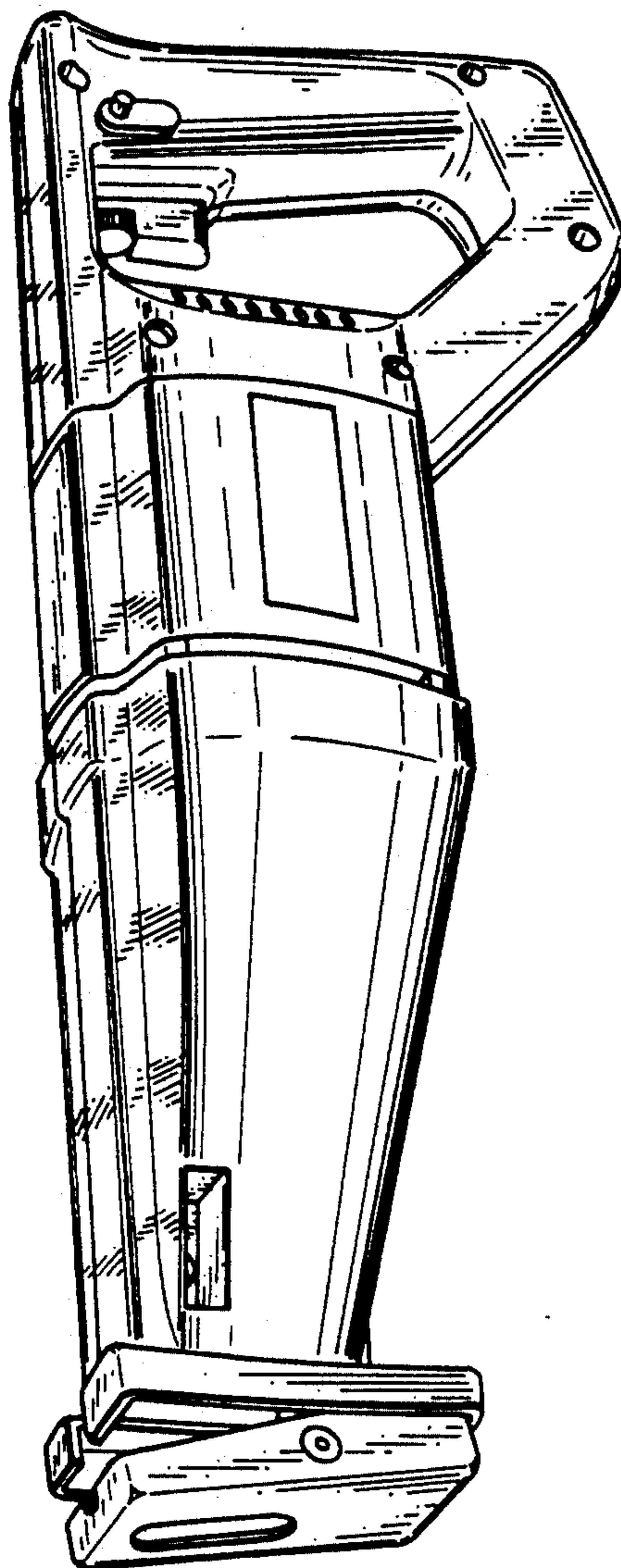

*Fig. 2*

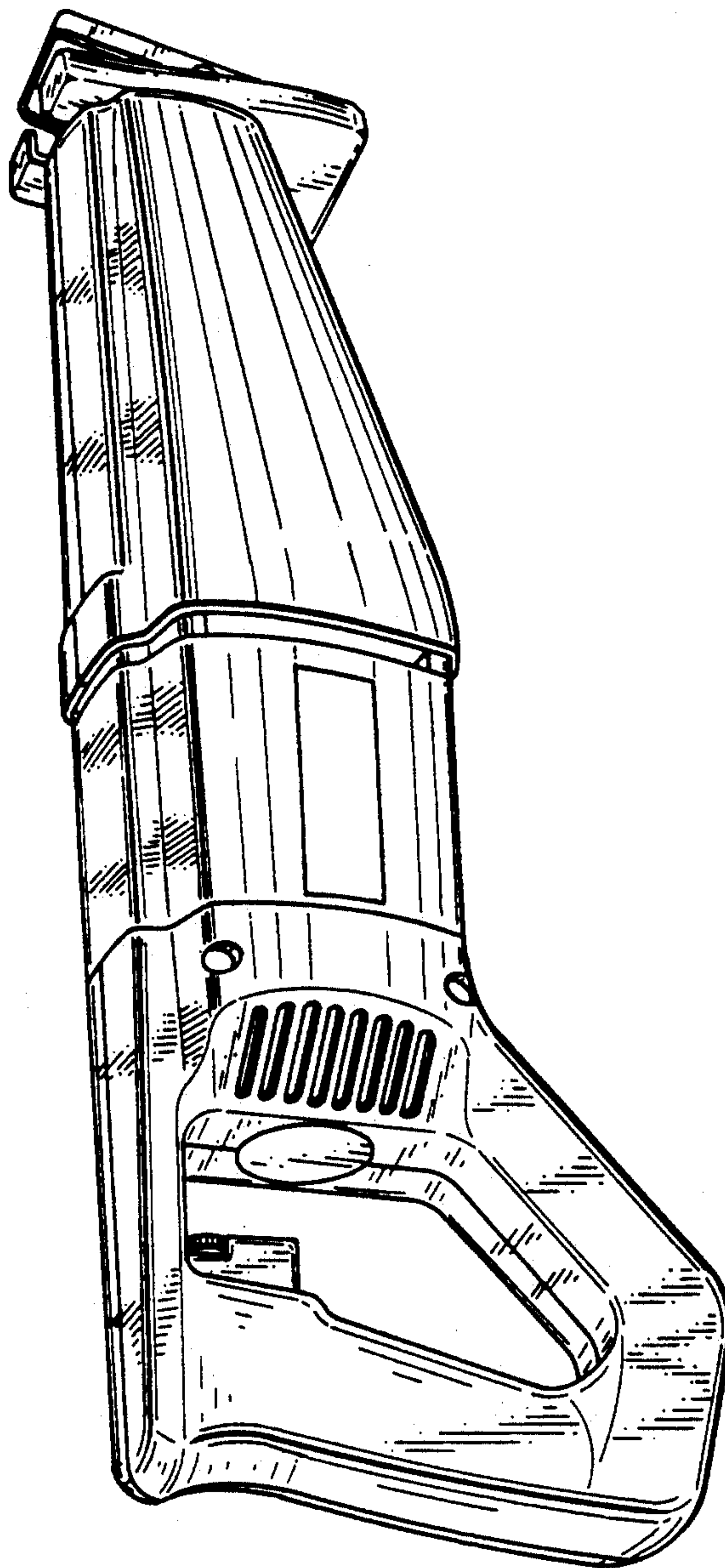

*Fig. 3*

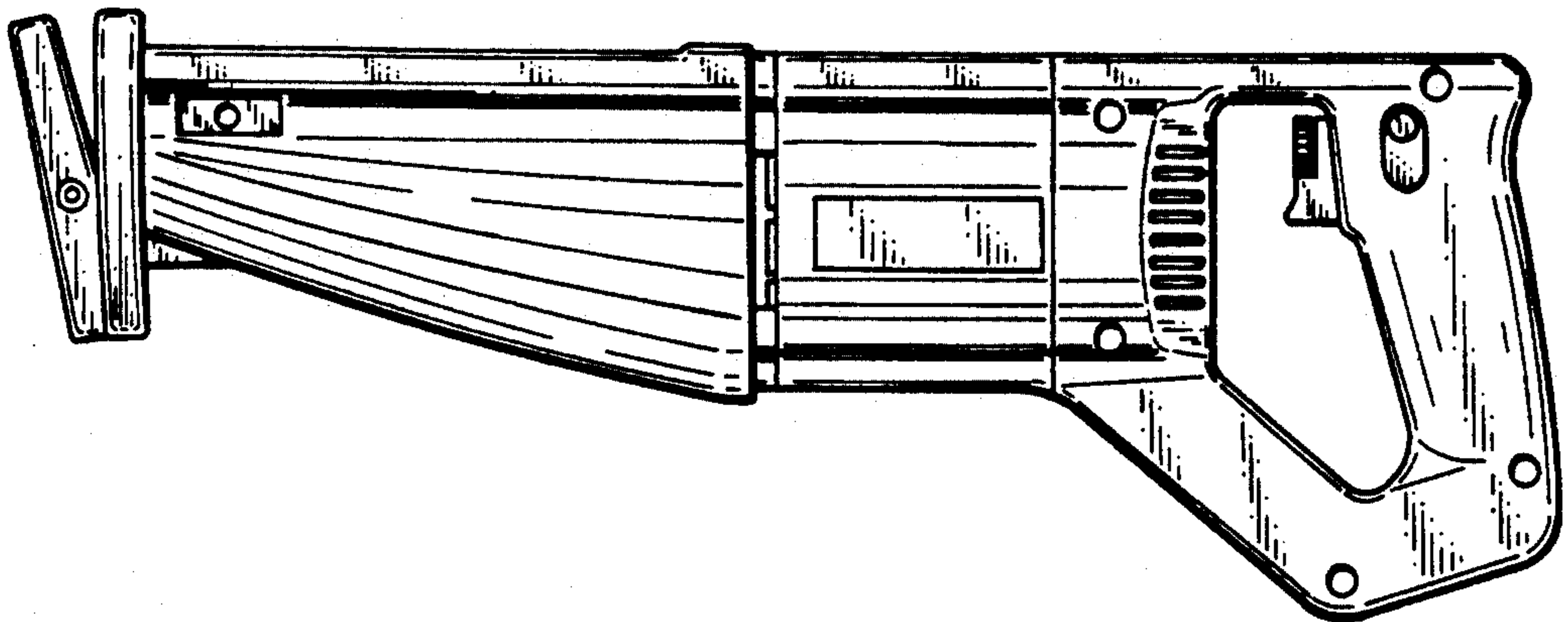

*Fig. 4*

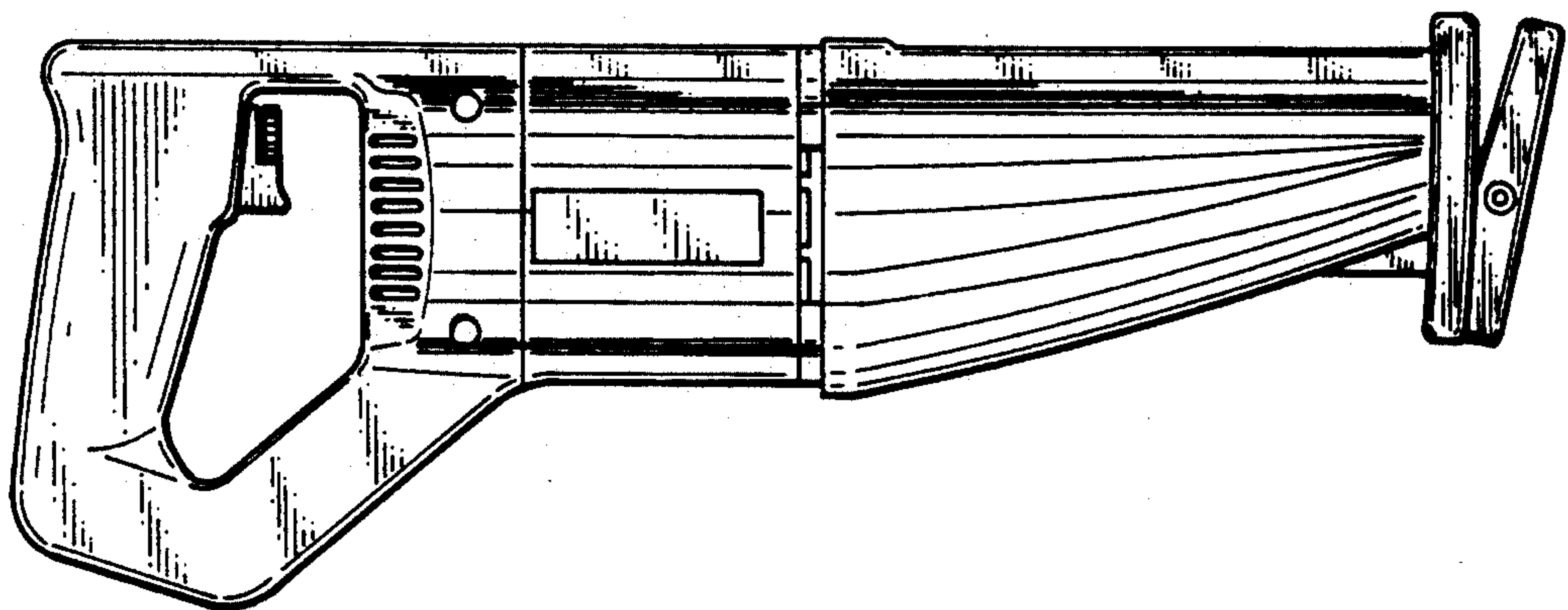

*Fig. 5*

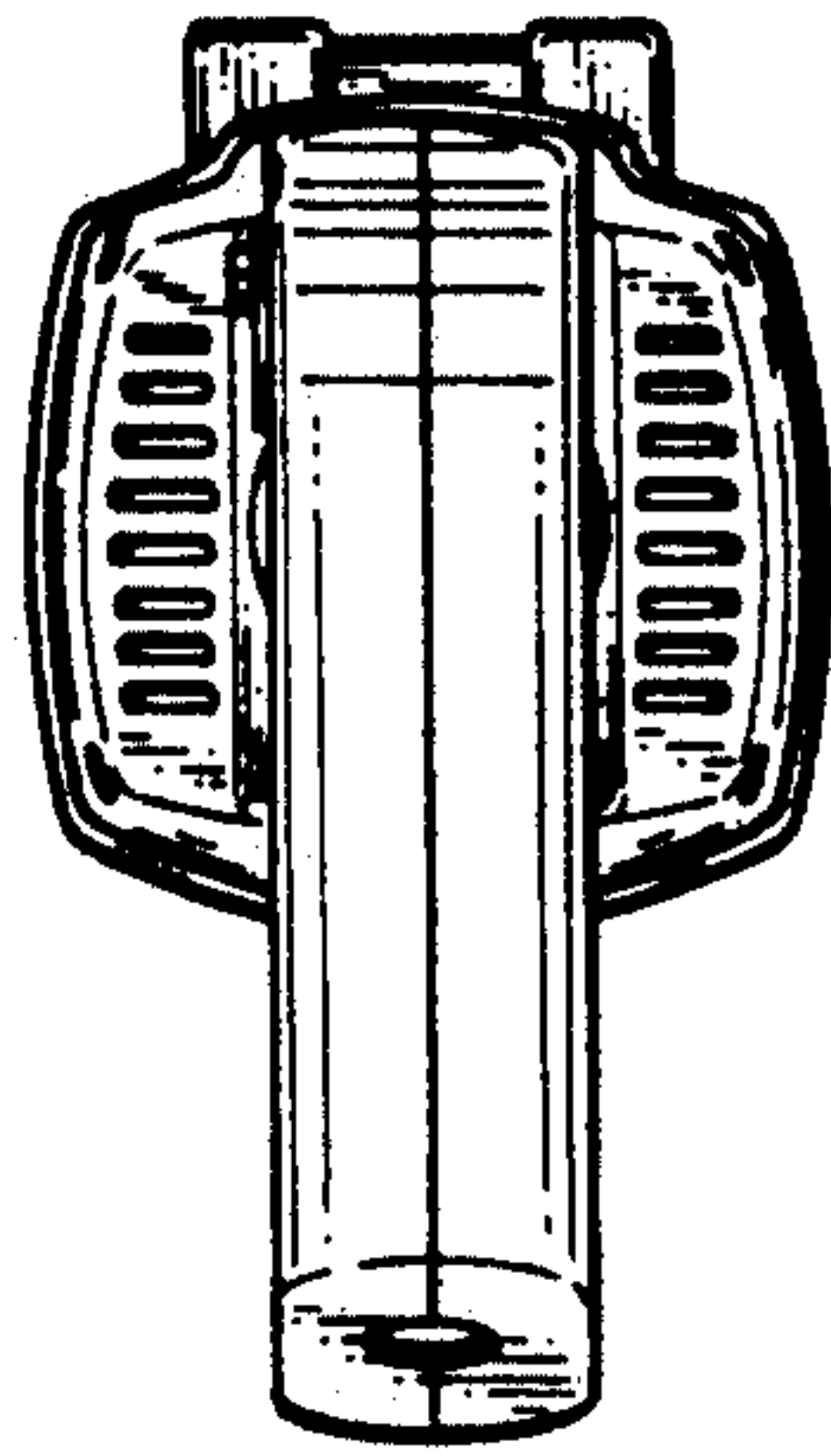

*Fig. 6*

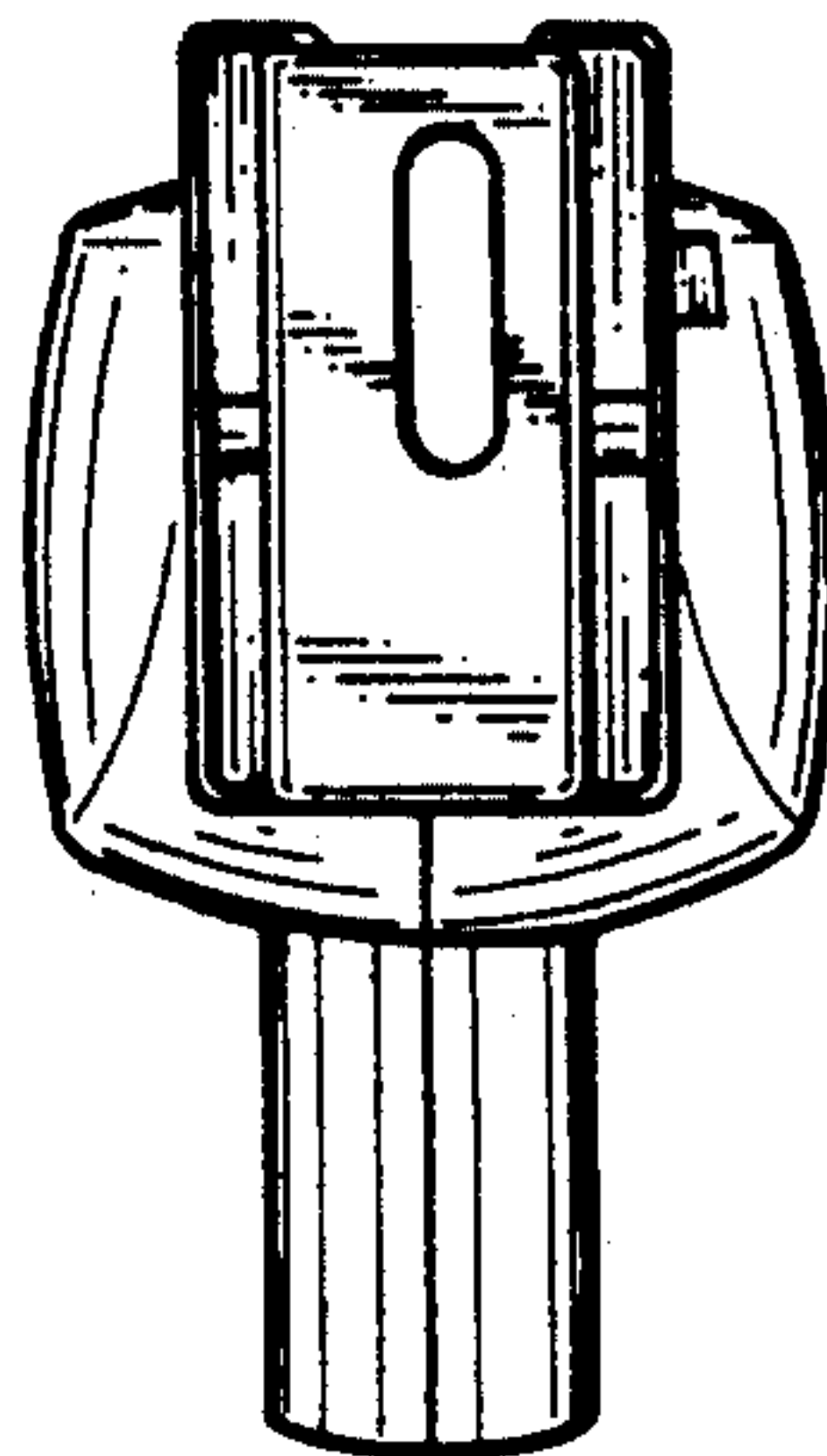



*Fig. 7*



*Fig. 8*

