



US00D339498S

United States Patent [19]

[11] Patent Number: **Des. 339,498**

Ancona et al.

[45] Date of Patent: **** Sep. 21, 1993**

[54] CARAFE

D. 311,110 10/1990 Hess D7/302

[76] Inventors: **Bruce Ancona; Jane Ancona**, both of 21 E. 22nd St., Apartment 6K, New York City, N.Y. 10010

OTHER PUBLICATIONS

"Gifts & Decorative Accessories", p. 38, Oct. 1979, Celadon Cat. Pitcher by Takahashi.

[**] Term: **14 Years**

Primary Examiner—Alan P. Douglas
Assistant Examiner—M. N. Pandozzi
Attorney, Agent, or Firm—James A. Drobile; Robert A. Koons; Robert Rosenthal

[21] Appl. No.: **924,112**

[22] Filed: **Aug. 10, 1992**

[52] U.S. Cl. **D7/302; D7/599**

[58] Field of Search **D7/302, 301, 604, 318, D7/516, 623, 606, 599, 598, 316, 317; D11/158**

[57] CLAIM

The ornamental design for a carafe, as shown.

[56] References Cited

DESCRIPTION

U.S. PATENT DOCUMENTS

D. 94,012	8/1934	Wright	D7/543
D. 148,056	12/1947	Falk	D44/21
D. 166,603	11/1951	Hartman	D7/302
D. 167,068	6/1952	Chase	D11/158
D. 277,069	1/1985	Ostergard	D7/302
D. 282,339	1/1986	Wei	D7/77
D. 288,889	3/1987	Mantani	D7/312

FIG. 1 is a perspective view of a carafe showing our new design;

FIG. 2 is a front elevational view thereof;

FIG. 3 is a rear elevational view thereof;

FIG. 4 is a top plan view thereof;

FIG. 5 is a bottom plan view thereof;

FIG. 6 is a left side elevational view thereof; and,

FIG. 7 is a right side elevational view thereof.

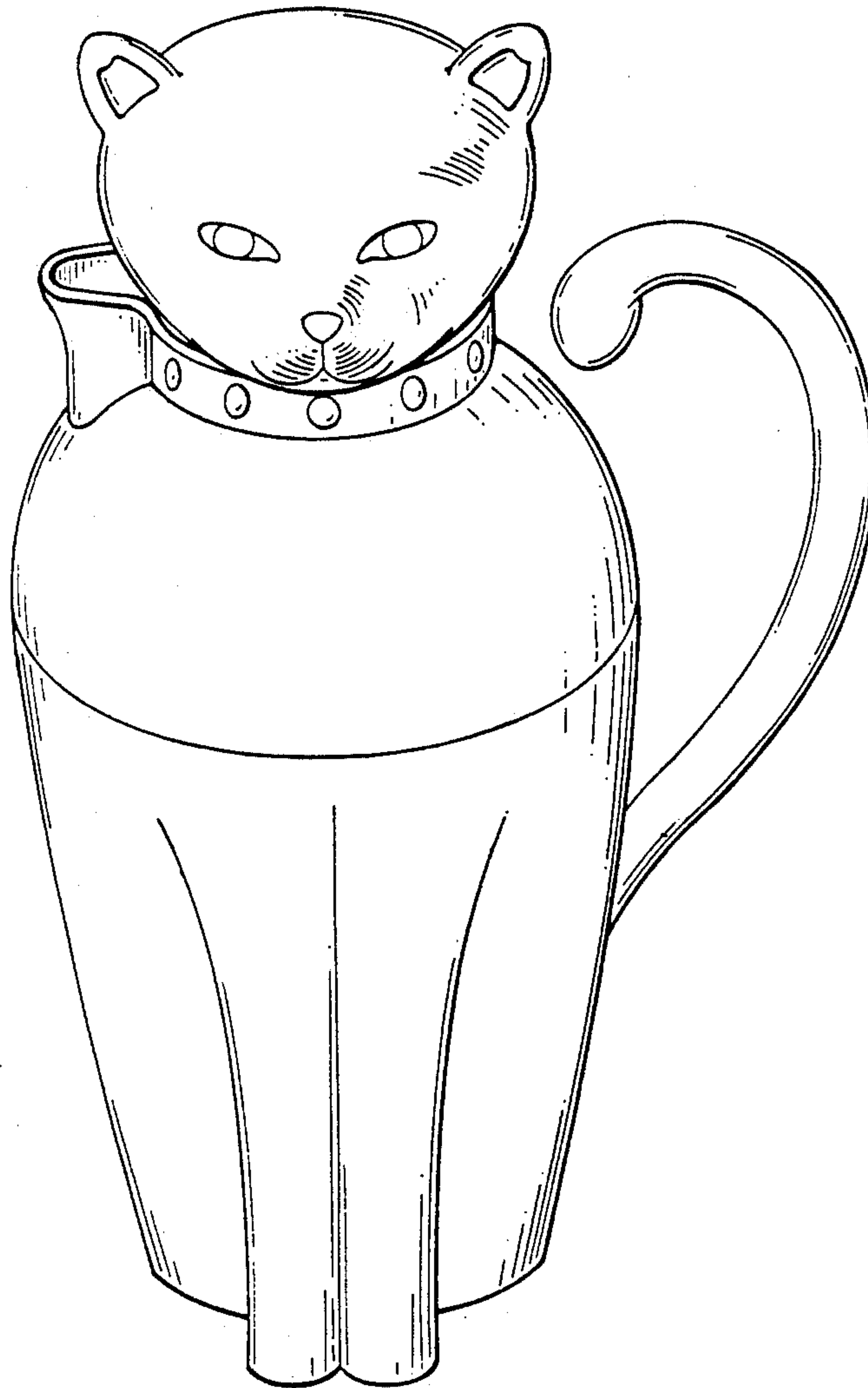

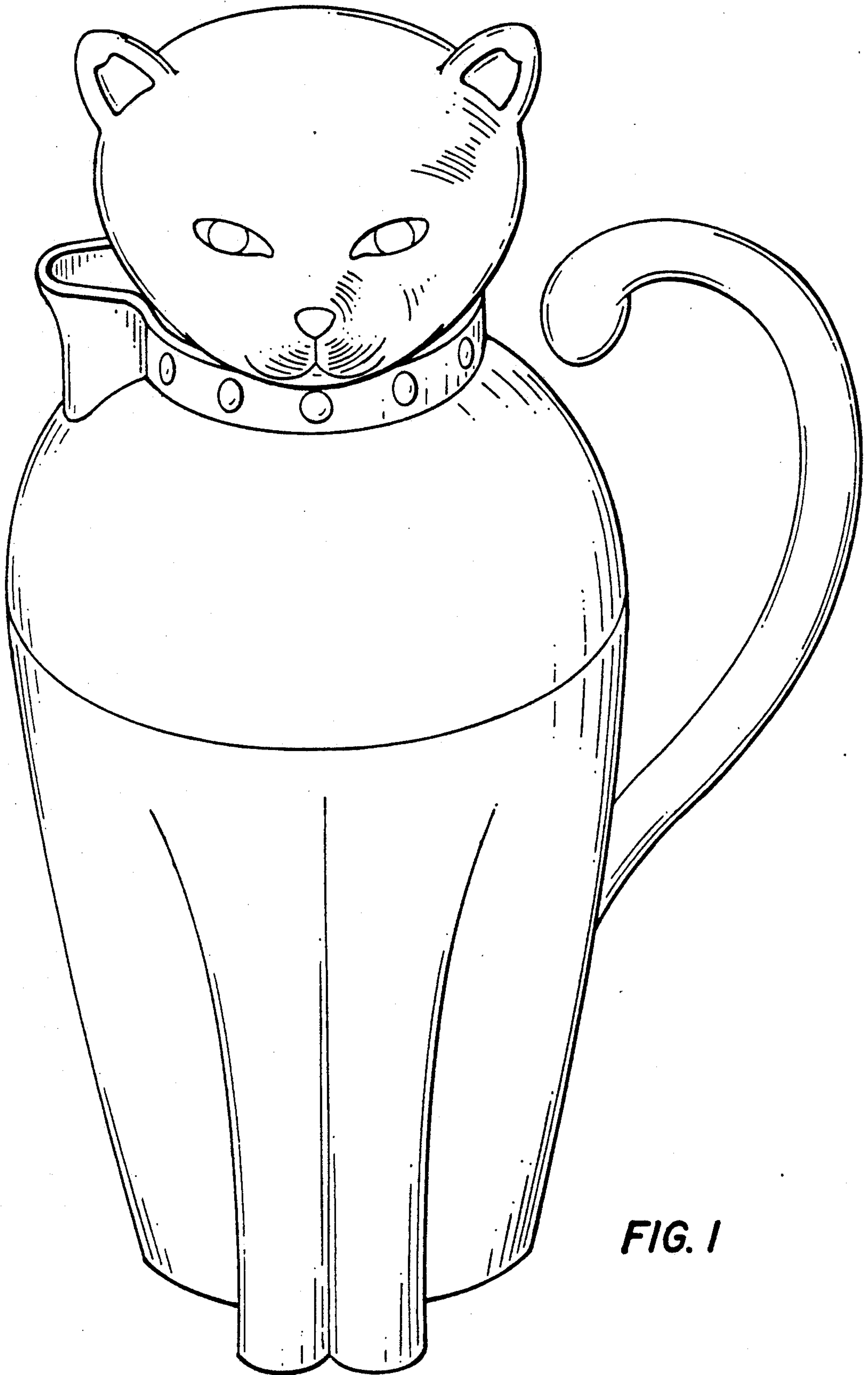

FIG. 1

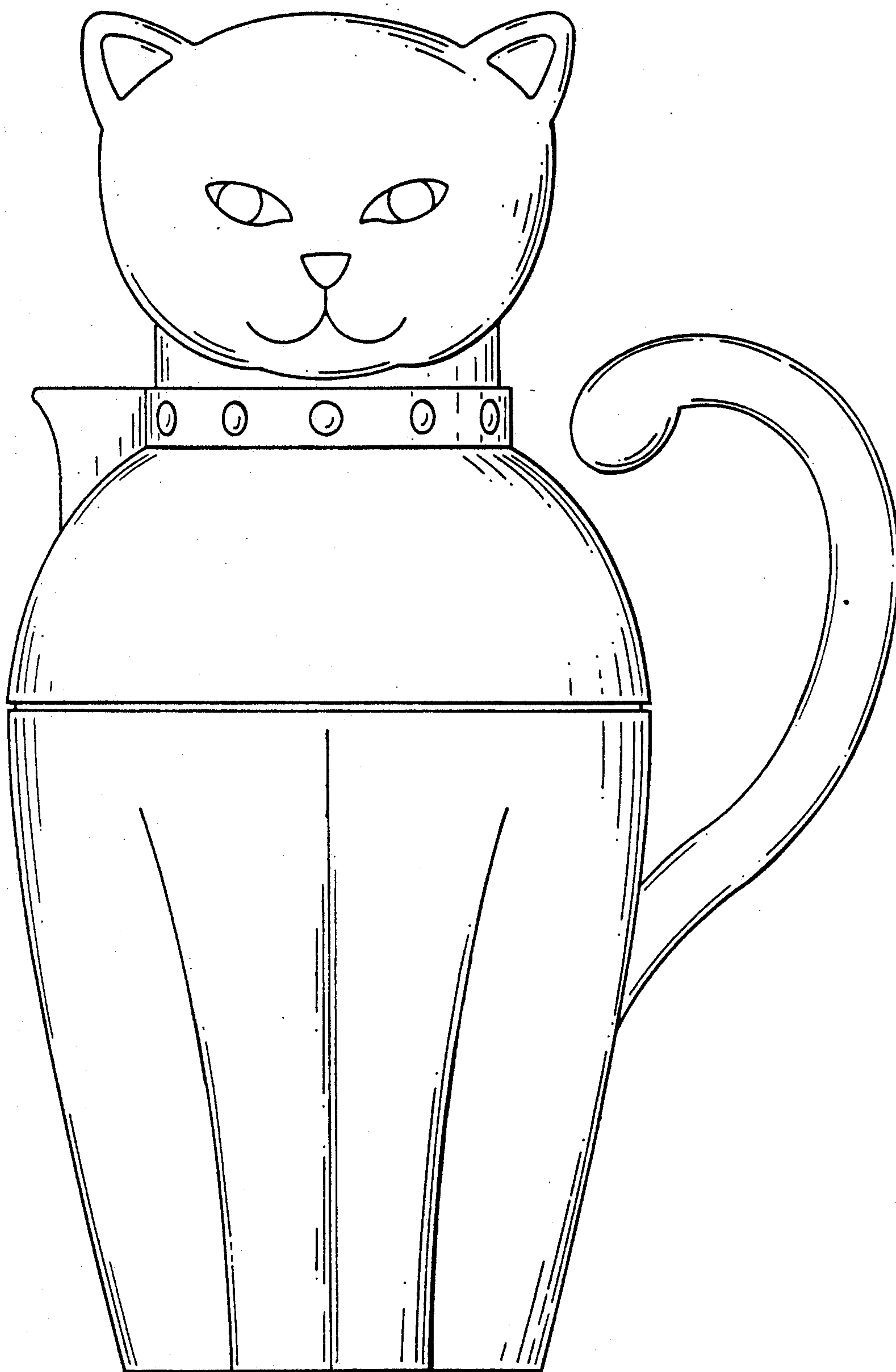

FIG. 2

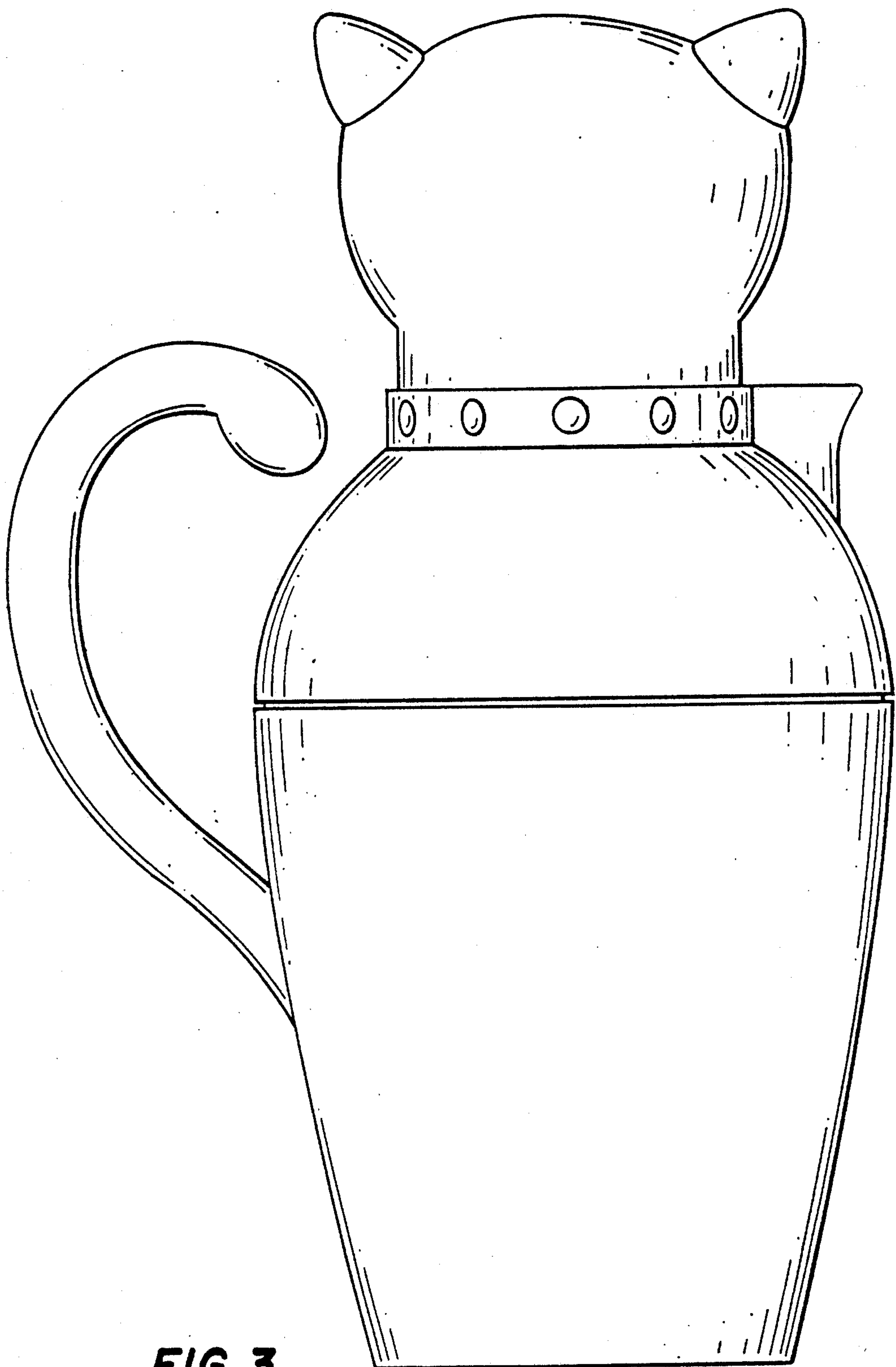

FIG. 3

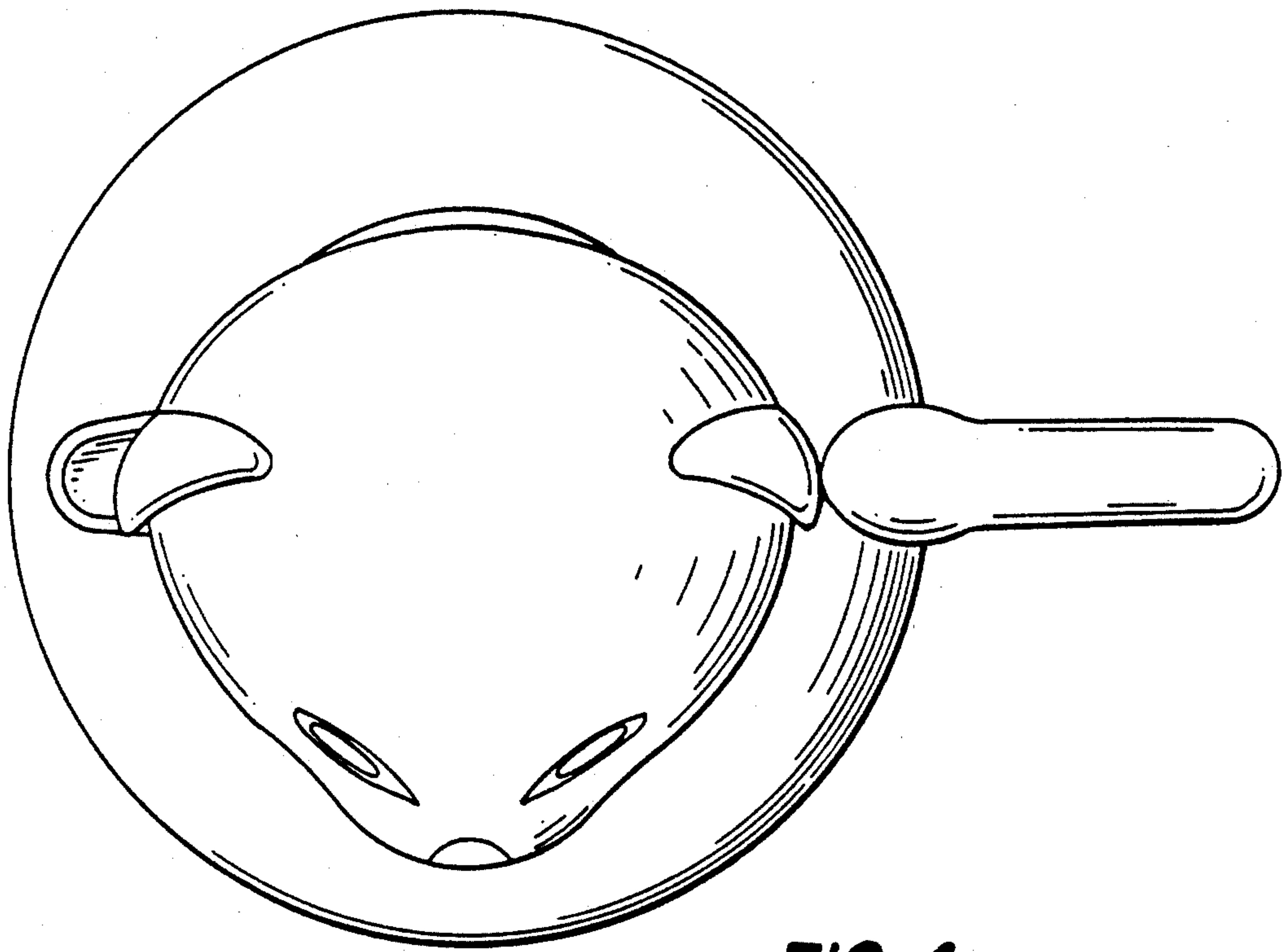

FIG. 4

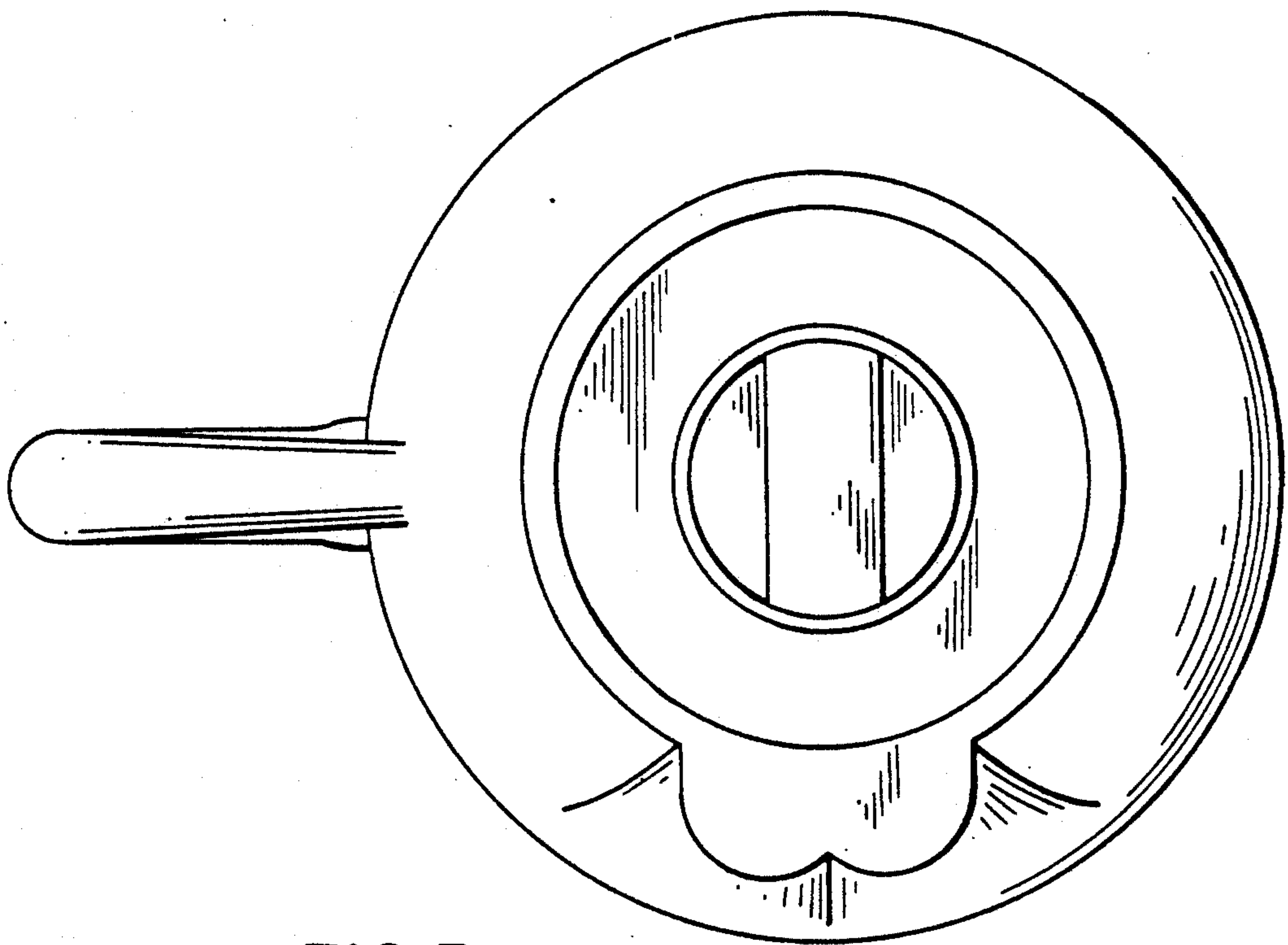

FIG.5

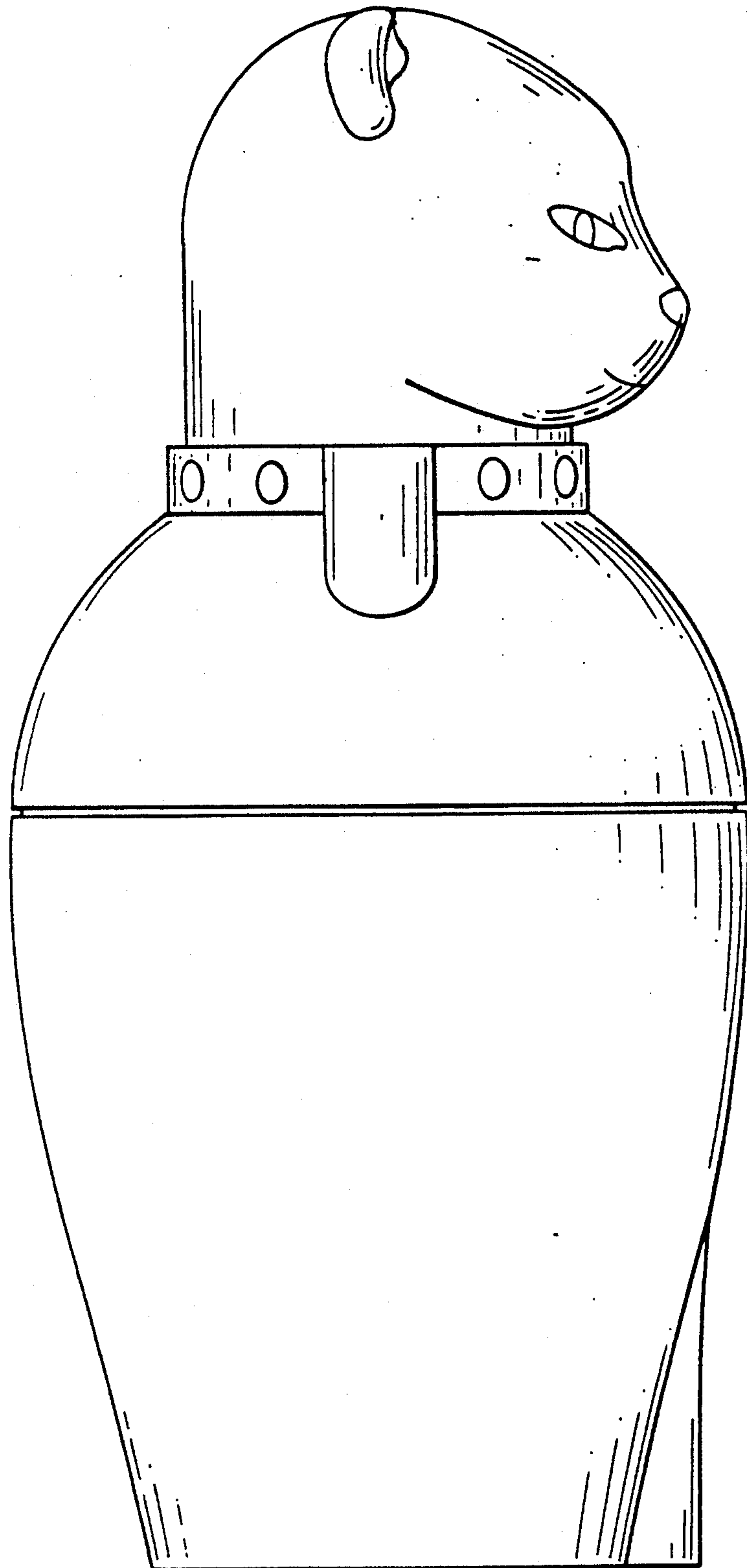

FIG. 6

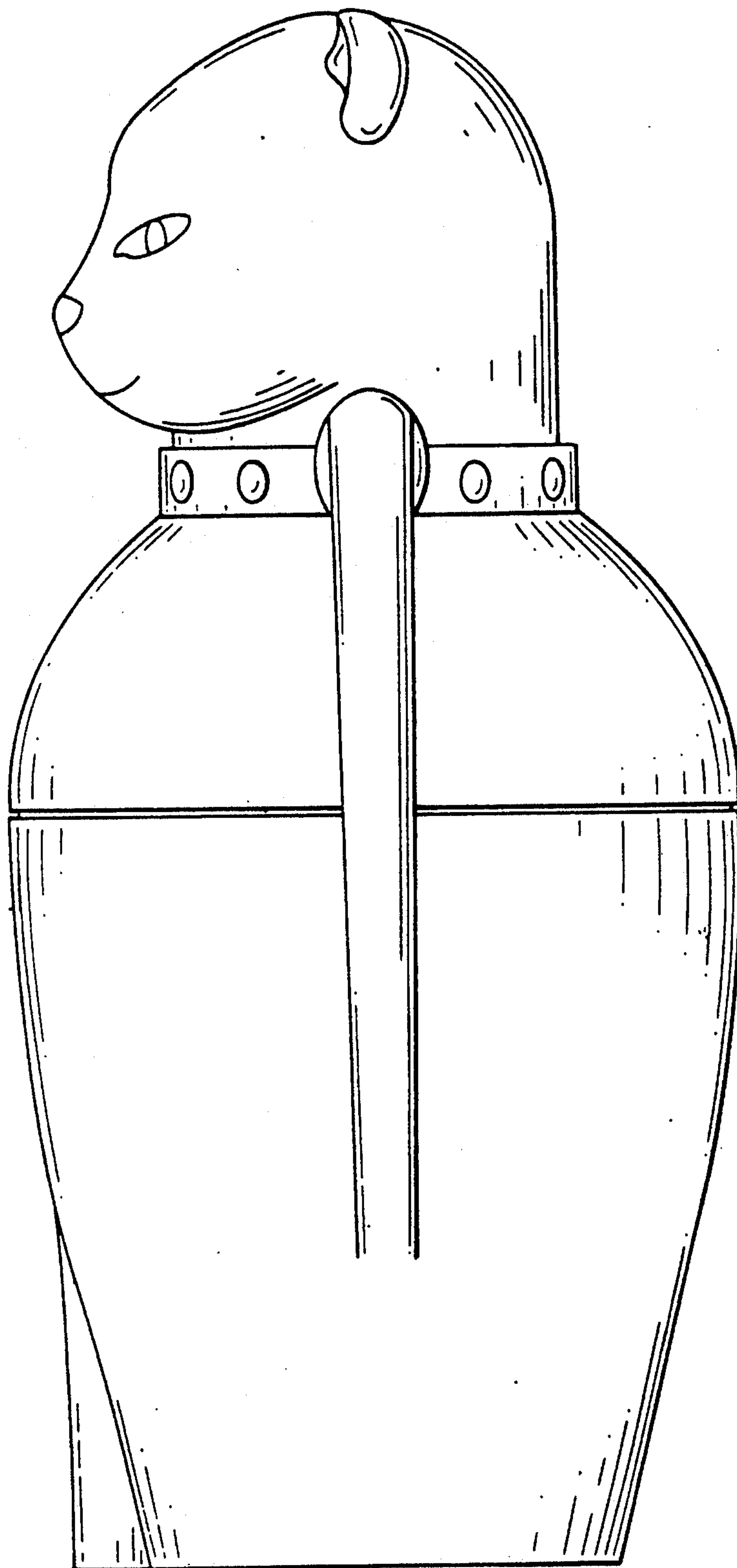

FIG. 7