



US00D339433S

United States Patent [19]

Stein et al.

[11] Patent Number: **Des. 339,433**

[45] Date of Patent: **** Sep. 14, 1993**

[54] **VACUUM CLEANER**

[75] Inventors: **Klaus Stein; Heinz Kaulig**, both of Velbert, Fed. Rep. of Germany

[73] Assignee: **Stein & Co. GmbH**, Velbert, Fed. Rep. of Germany

[**] Term: **14 Years**

[21] Appl. No.: **748,453**

[22] Filed: **Aug. 22, 1991**

Related U.S. Application Data

[63] Continuation-in-part of Ser. No. 747,185, Mar. 19, 1991.

Foreign Application Priority Data

Apr. 18, 1991 [DE] Fed. Rep. of Germany 9104750

[52] U.S. Cl. **D32/22**

[58] Field of Search **D32/21-22, D32/32-34; 15/323-326, 327.6, 335, 350-351, 361, 377, 412**

References Cited

U.S. PATENT DOCUMENTS

D. 248,762	8/1978	Burgess et al.	D32/22
D. 293,728	1/1988	Ohhira et al.	D32/22
D. 301,784	6/1989	Petralia et al.	D32/22
D. 309,806	8/1990	Chieda et al.	D32/22
D. 316,167	4/1991	Petralia et al.	D32/22
D. 319,517	8/1991	Sovis et al.	D32/22
4,955,106	9/1990	Stein et al.	15/323

Primary Examiner—Ruth McInroy

Attorney, Agent, or Firm—Nils H. Ljungman & Associates

[57] CLAIM

The ornamental design for a vacuum cleaner, as shown and described.

DESCRIPTION

FIG. 1 is a front perspective view of a vacuum cleaner showing our new design;

FIG. 2 is a rear perspective view thereof;

FIG. 3 is a front elevational view thereof;

FIG. 4 is a left side elevational view thereof;

FIG. 5 is a right side elevational view thereof;

FIG. 6 is a top plan view thereof;

FIG. 7 is a bottom plan view thereof;

FIG. 8 is a front perspective view of a second embodiment thereof;

FIG. 9 is a rear perspective view thereof;

FIG. 10 is a front elevational view thereof;

FIG. 11 is a left side elevational view thereof;

FIG. 12 is a right side elevational view thereof;

FIG. 13 is a top plan view thereof;

FIG. 14 is a bottom plan view thereof;

FIG. 15 is a front perspective view of a third embodiment thereof;

FIG. 16 is a rear perspective view thereof;

FIG. 17 is a front elevational view thereof;

FIG. 18 is a left side elevational view thereof;

FIG. 19 is a top plan view thereof; and,

FIG. 20 is a bottom plan view thereof.

The electric cord is shown broken away in FIGS. 18-20 for ease of illustration and is understood to look like the cord in FIG. 16.

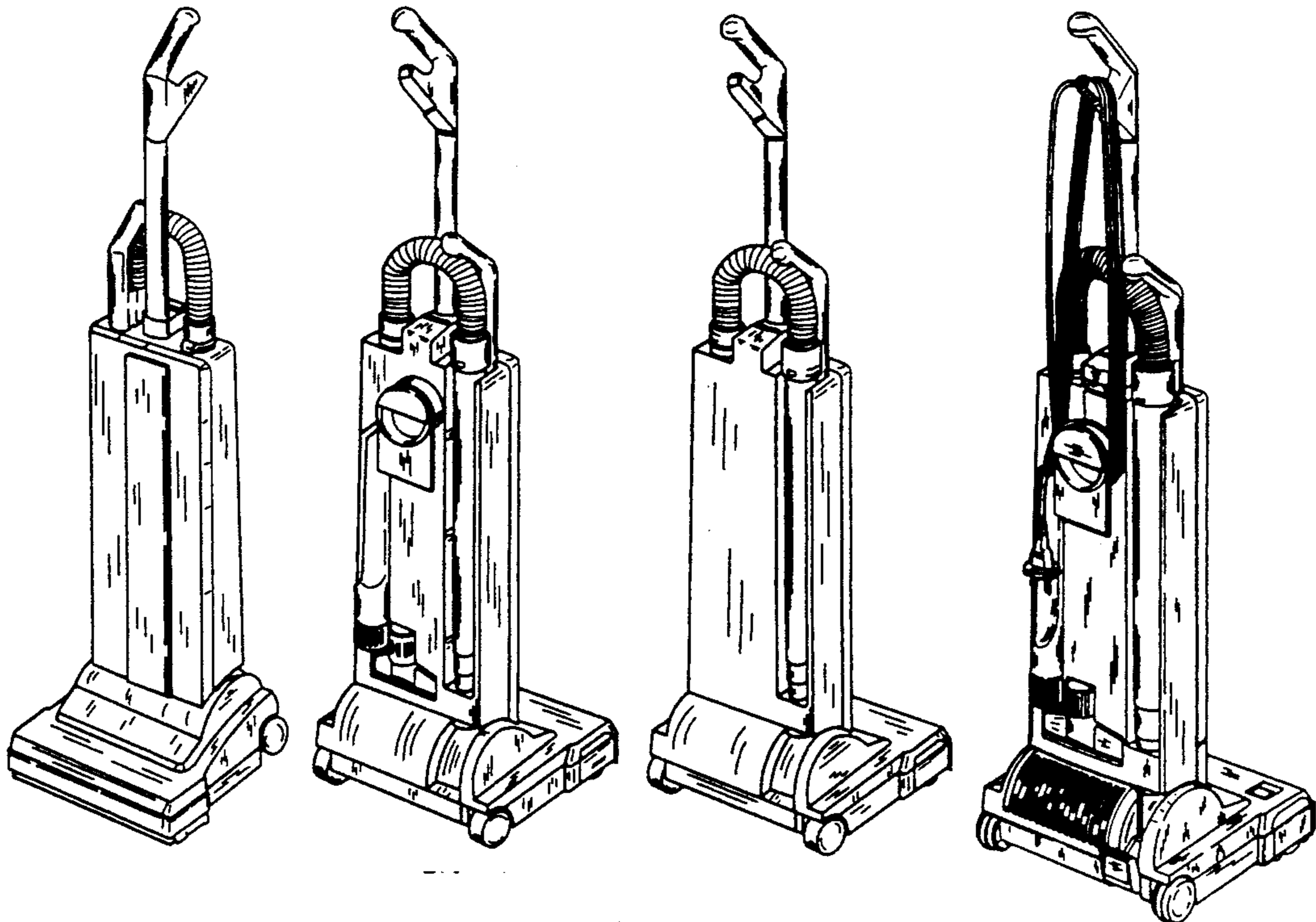

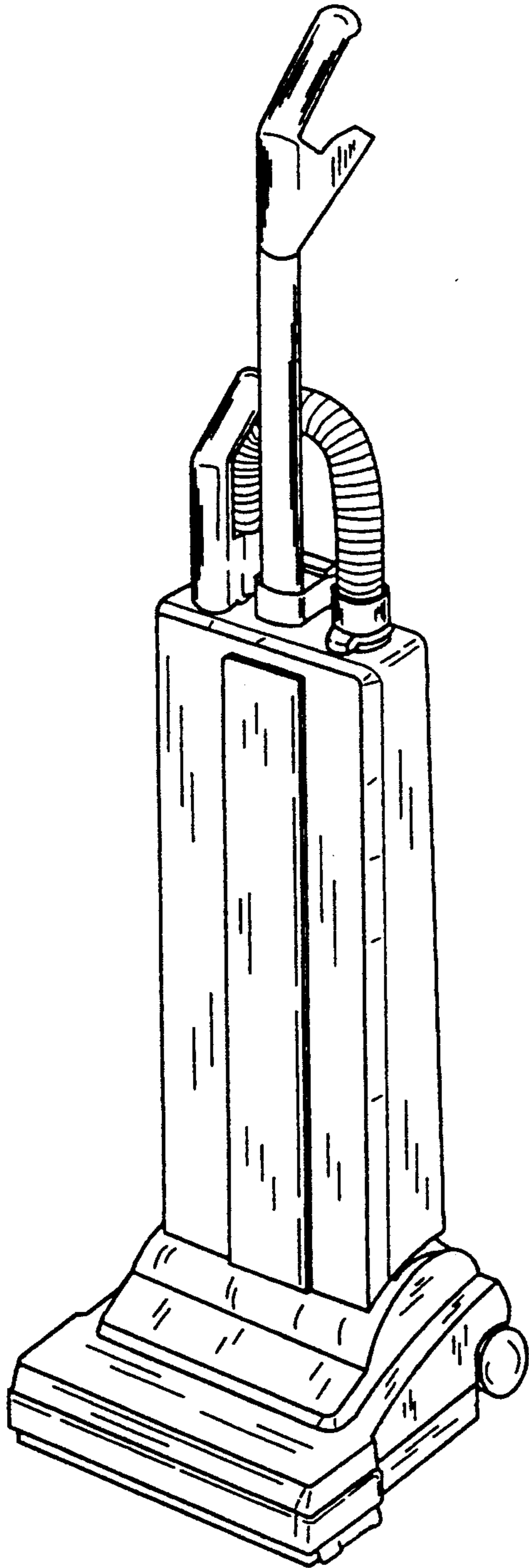

FIG. 1

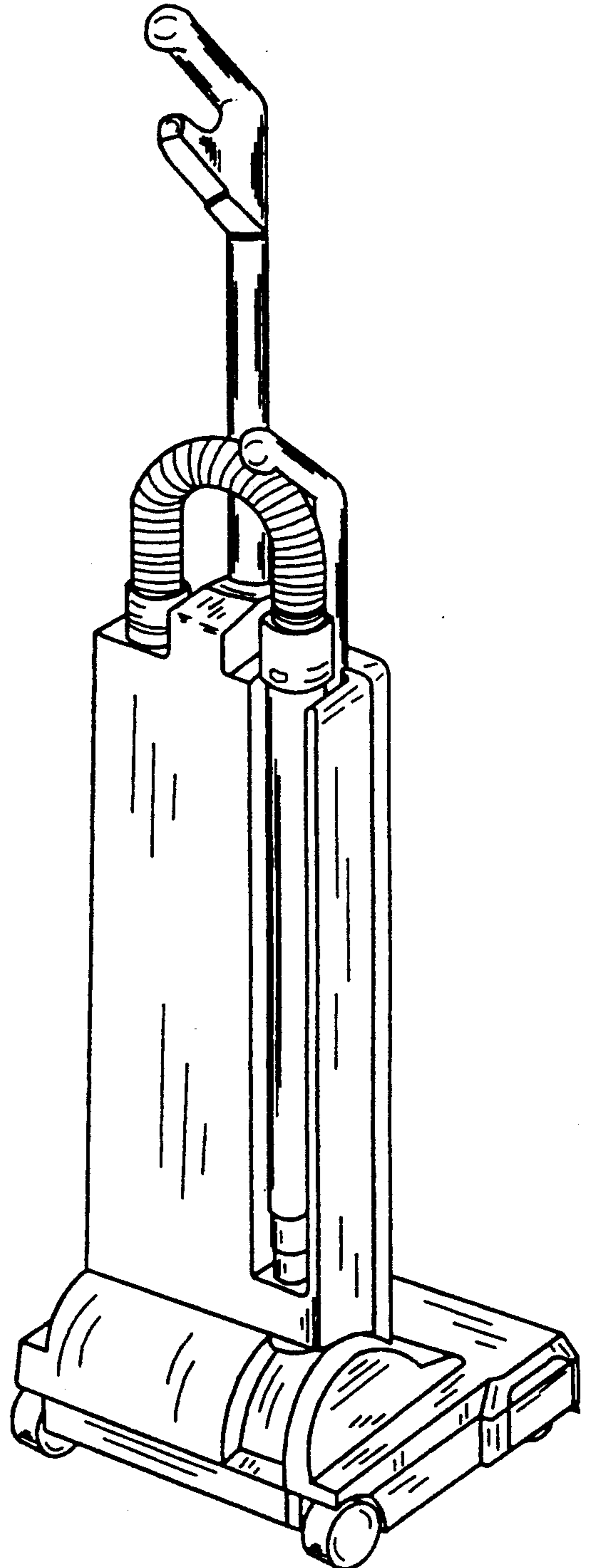

FIG. 2

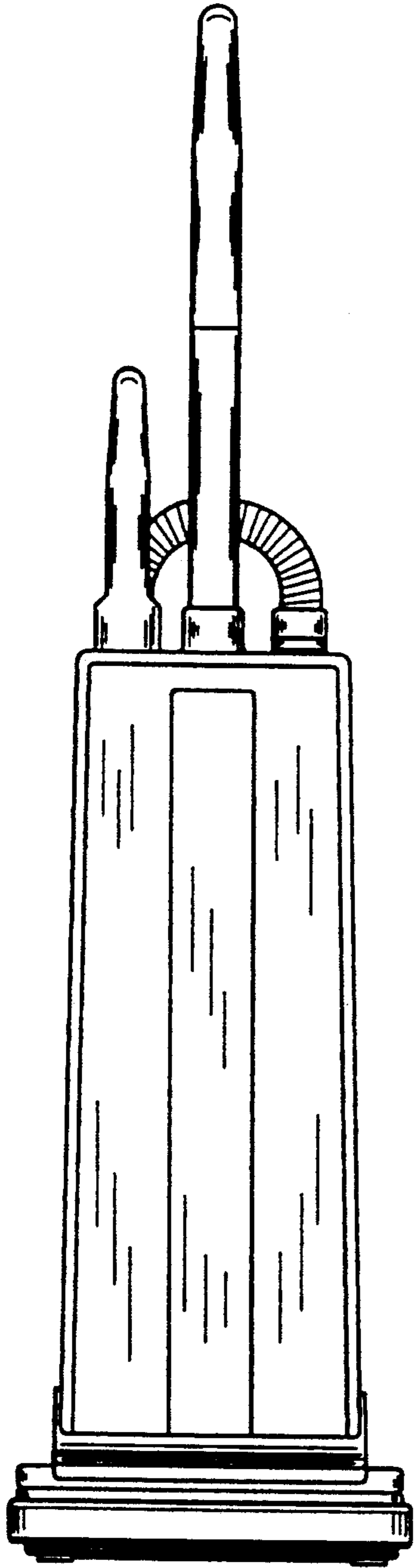

FIG. 3

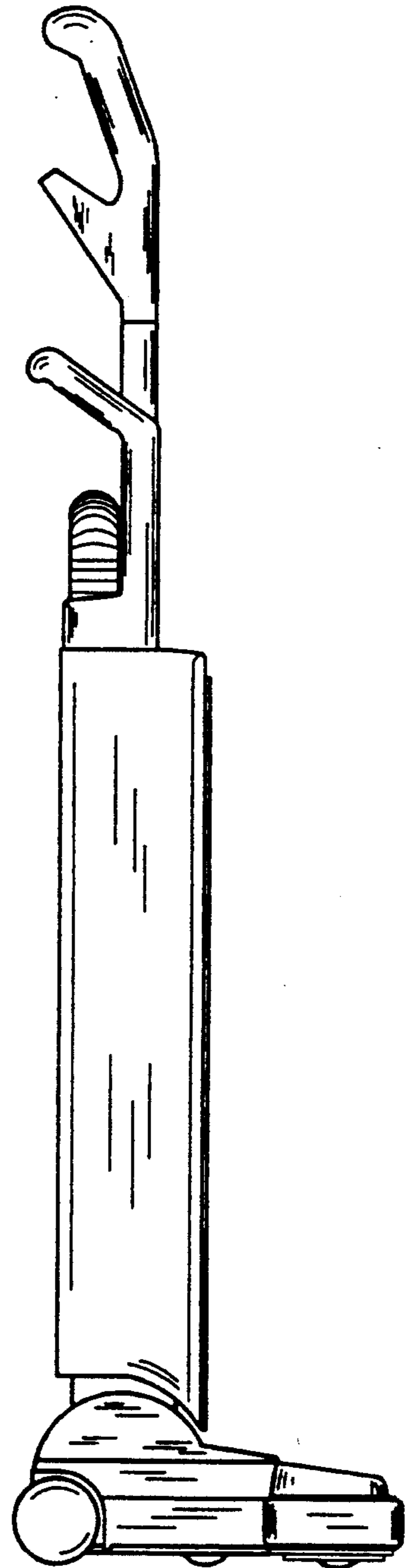

FIG. 4

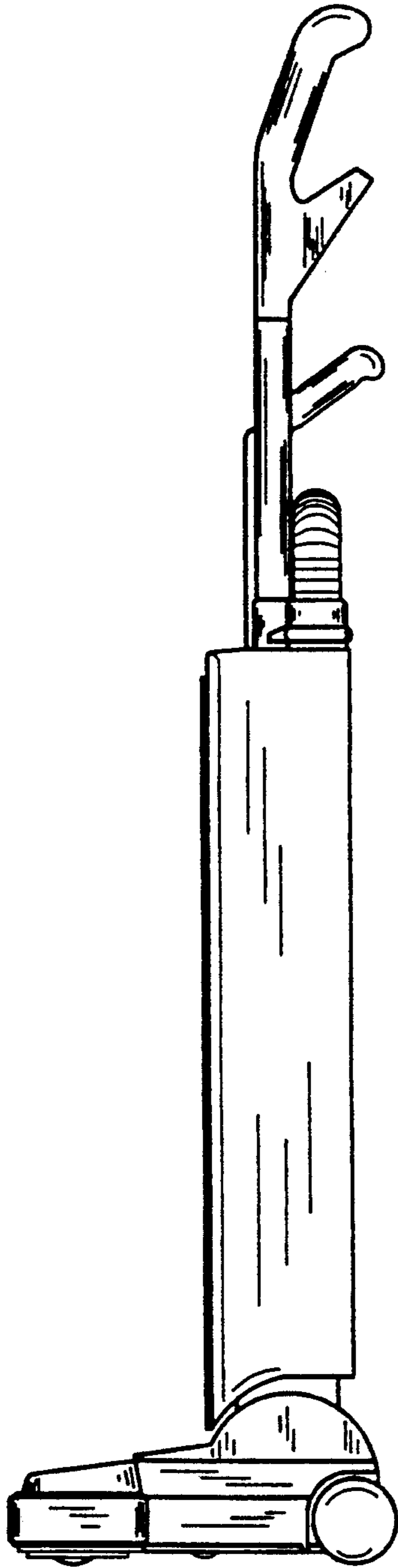

FIG. 5

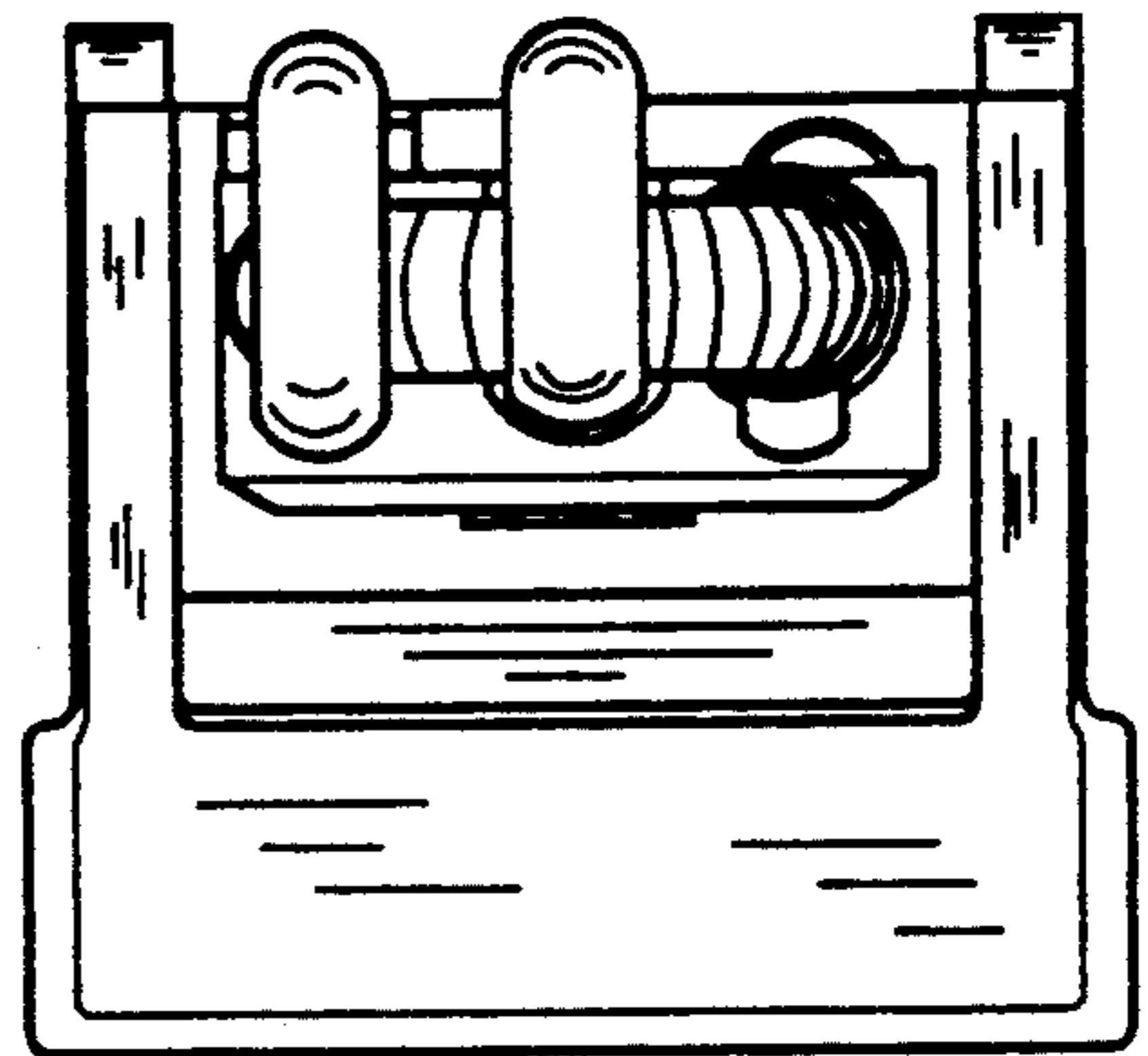

FIG. 6

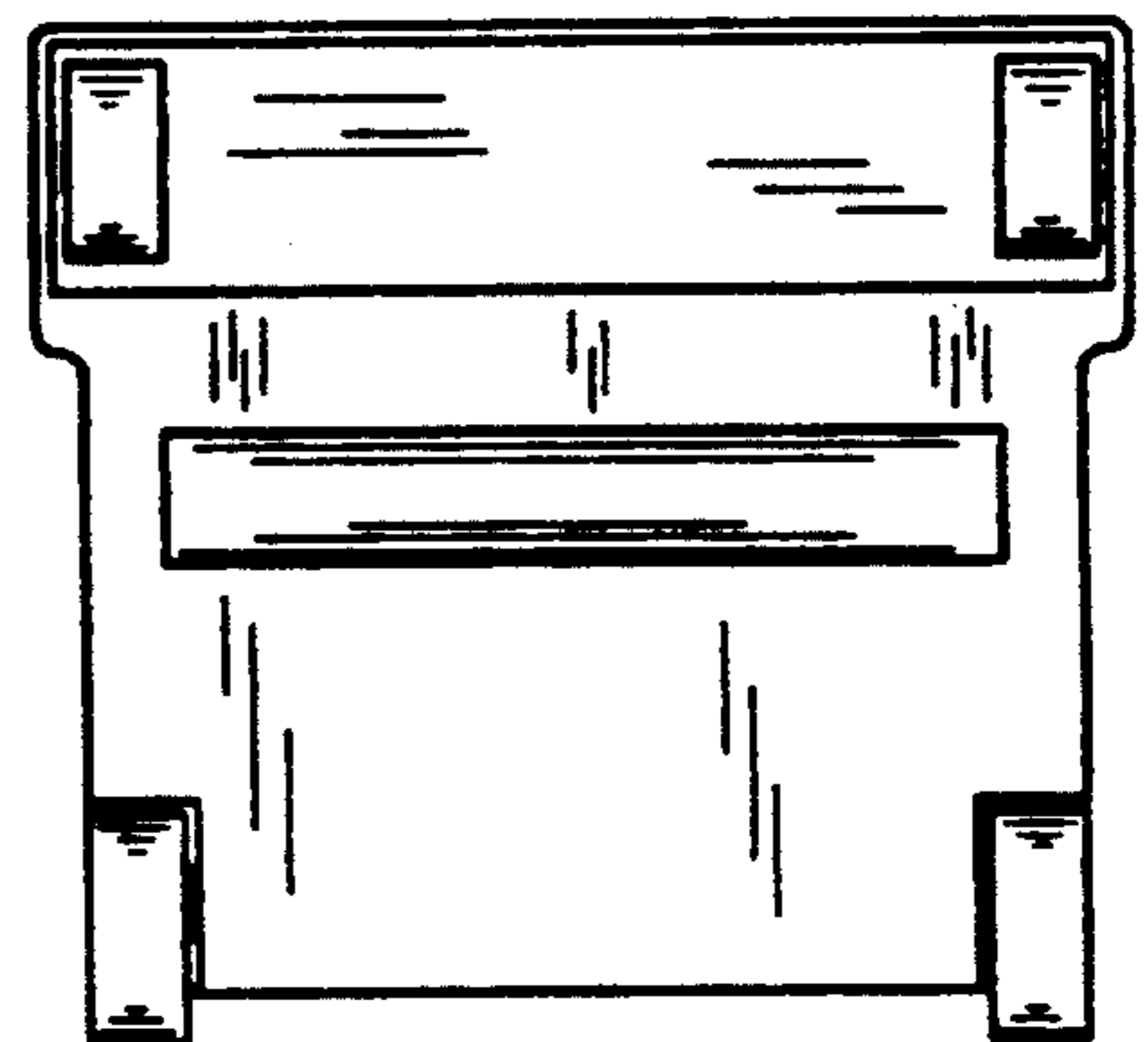

FIG. 7

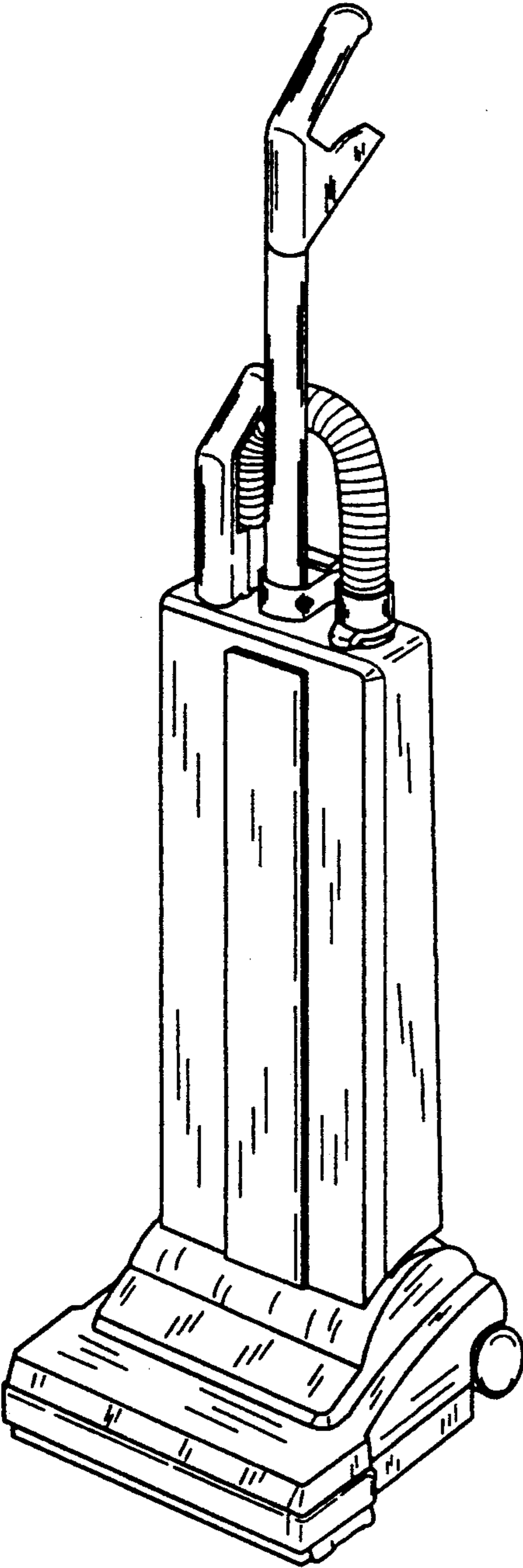

FIG. 8

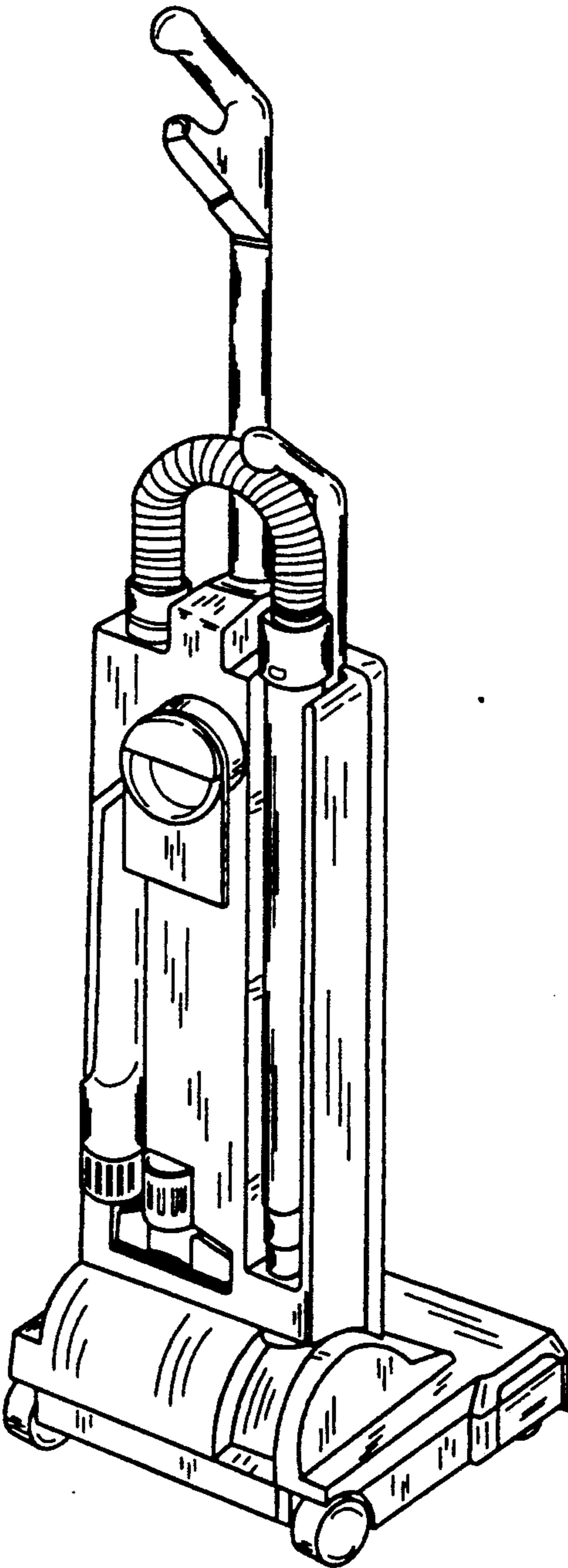

FIG. 9

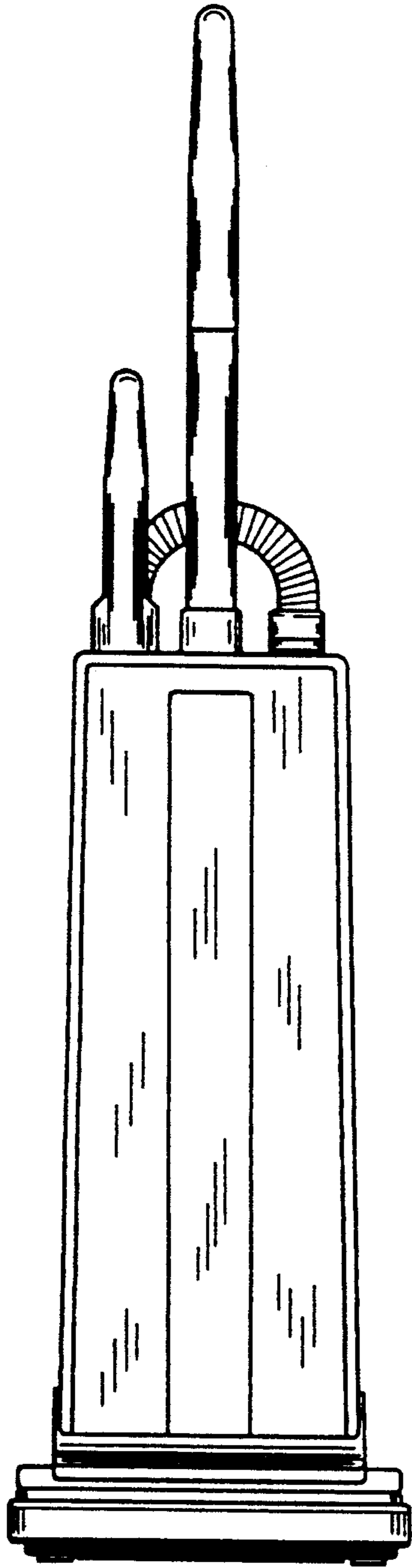

FIG. 10

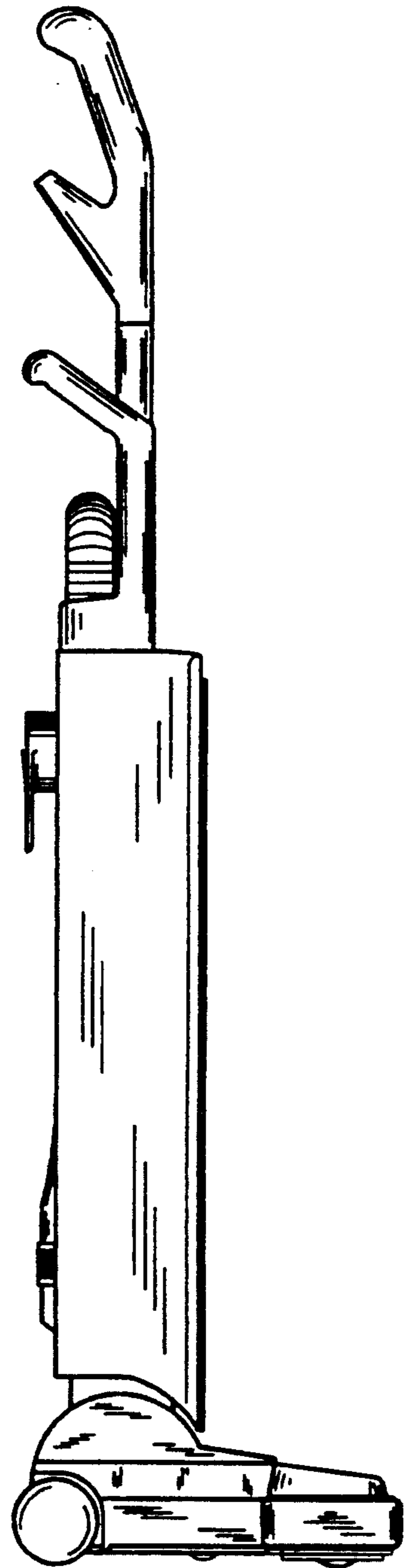

FIG. 11

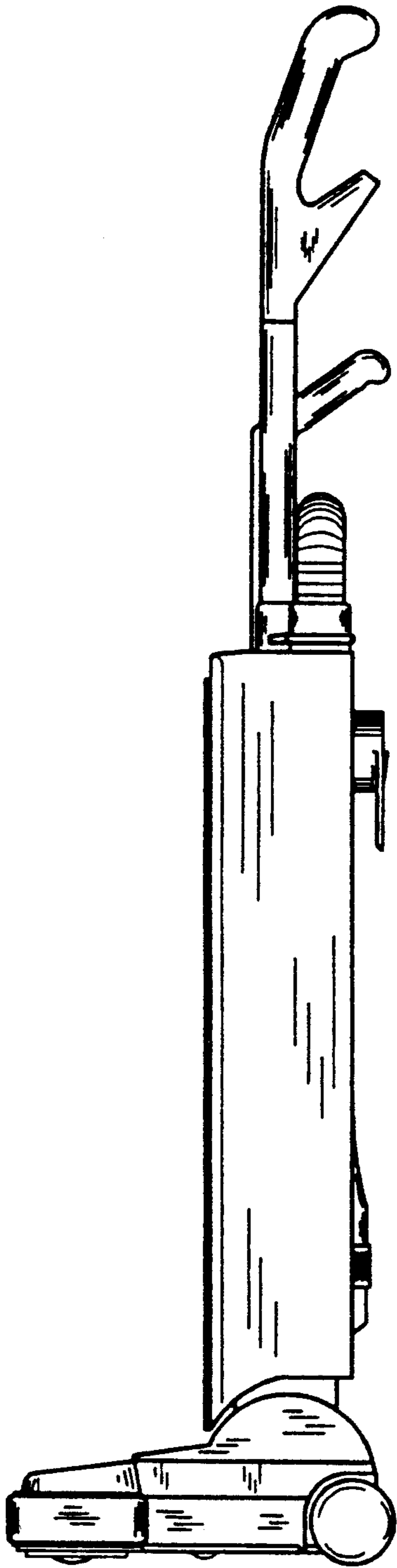

FIG. 12

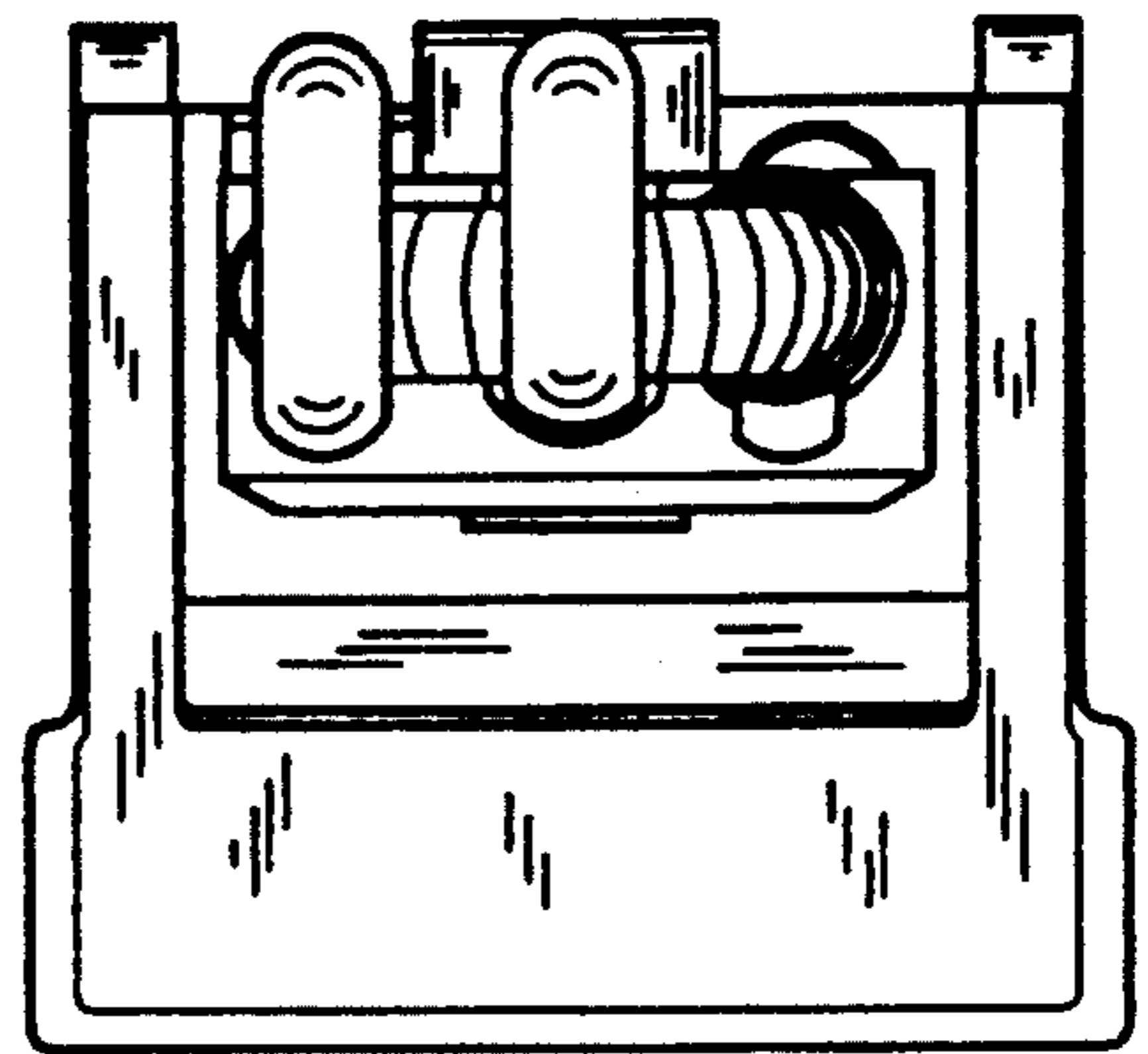

FIG. 13

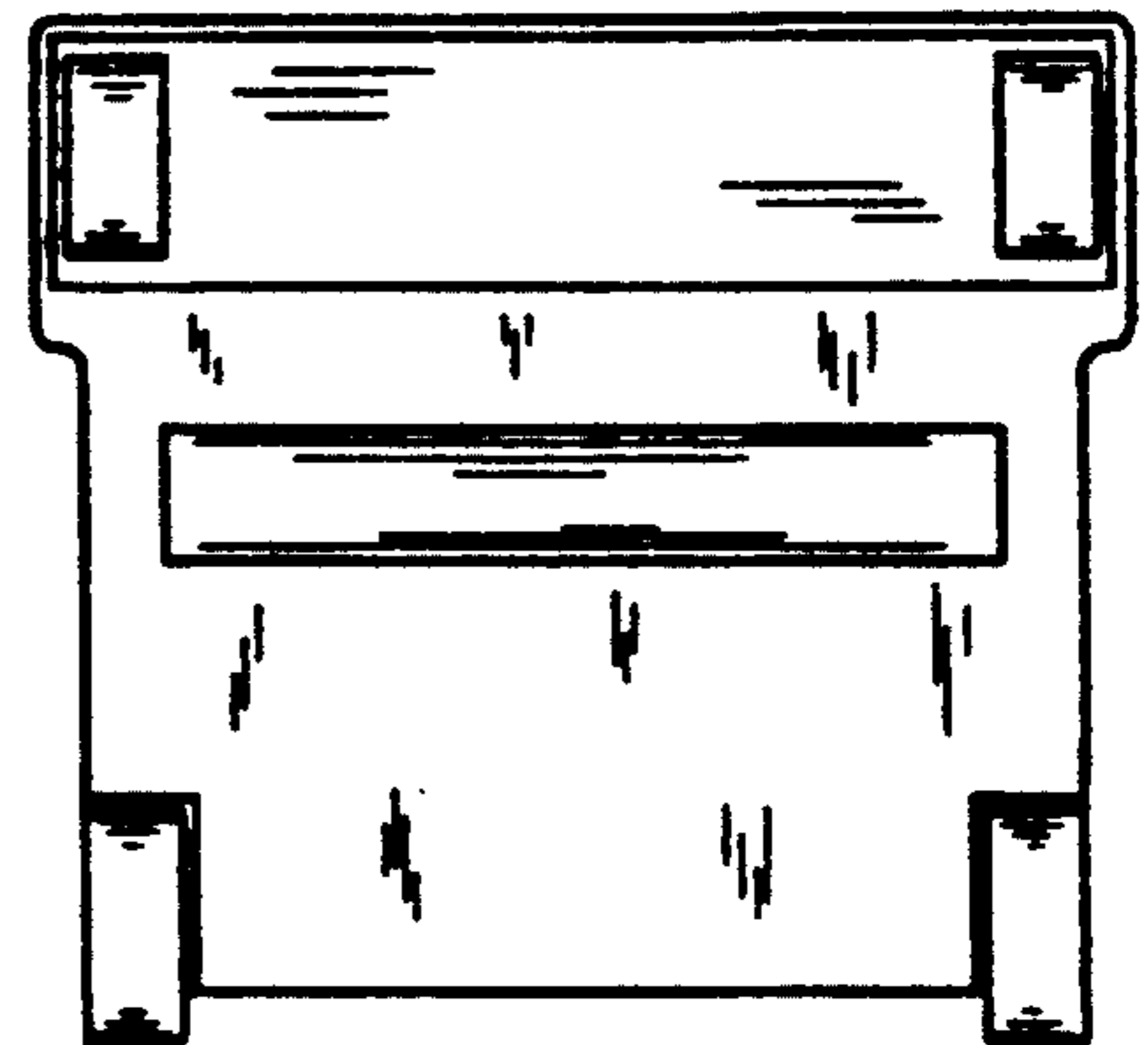

FIG. 14

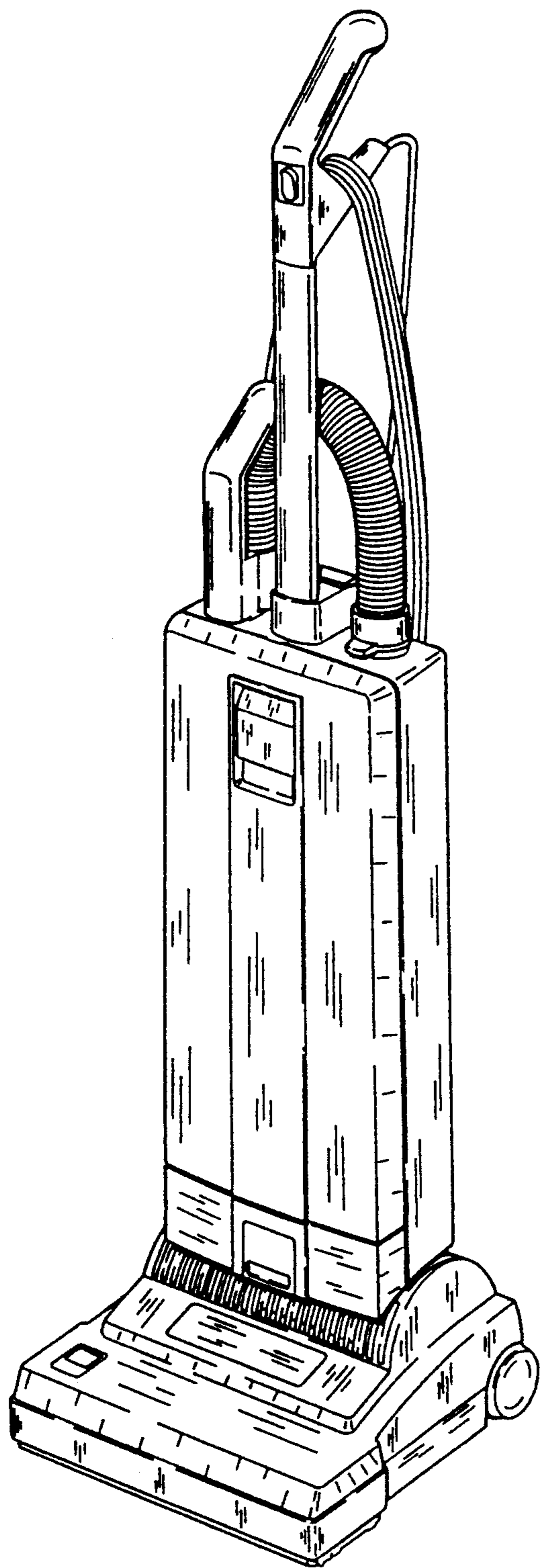

FIG. 15

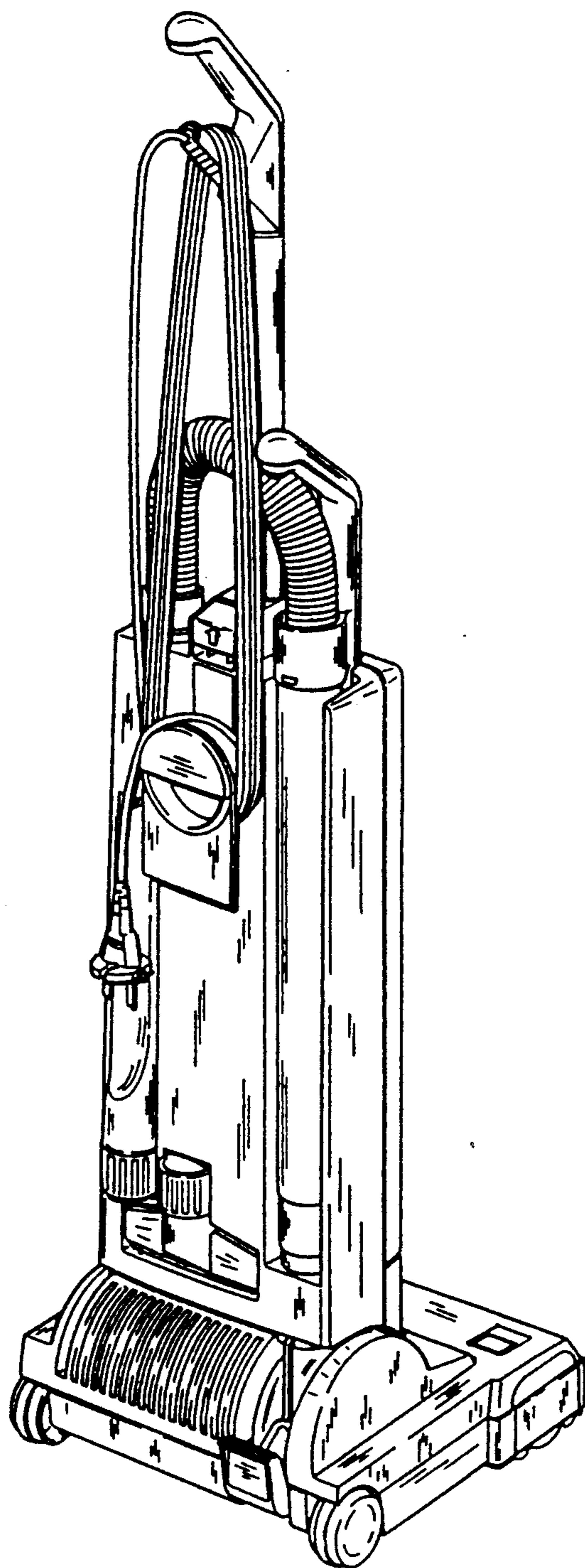

FIG. 16

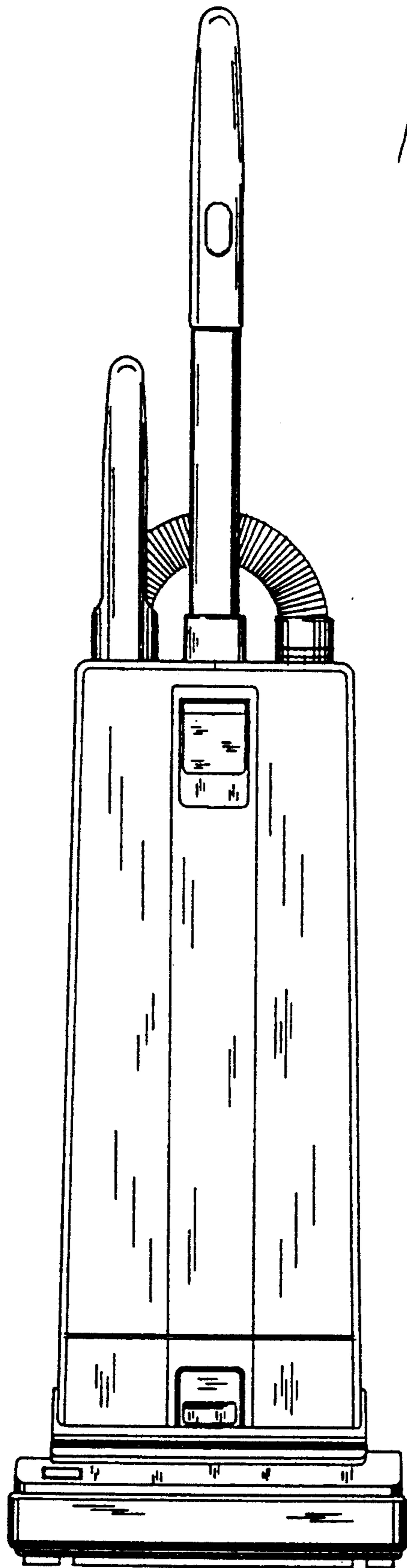

FIG. 17

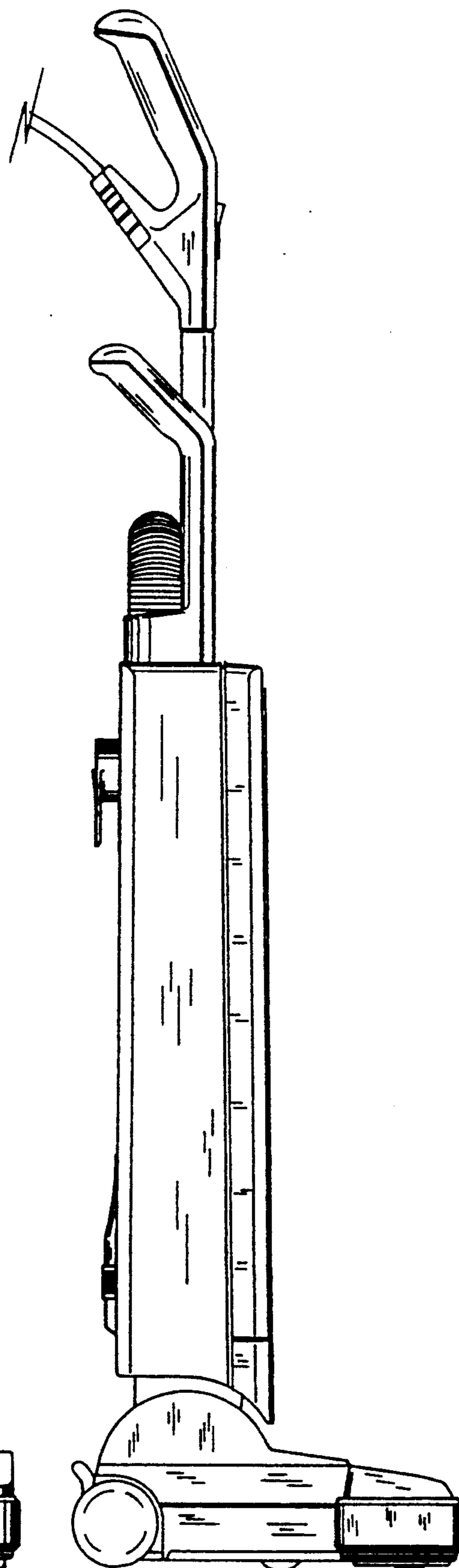

FIG. 18

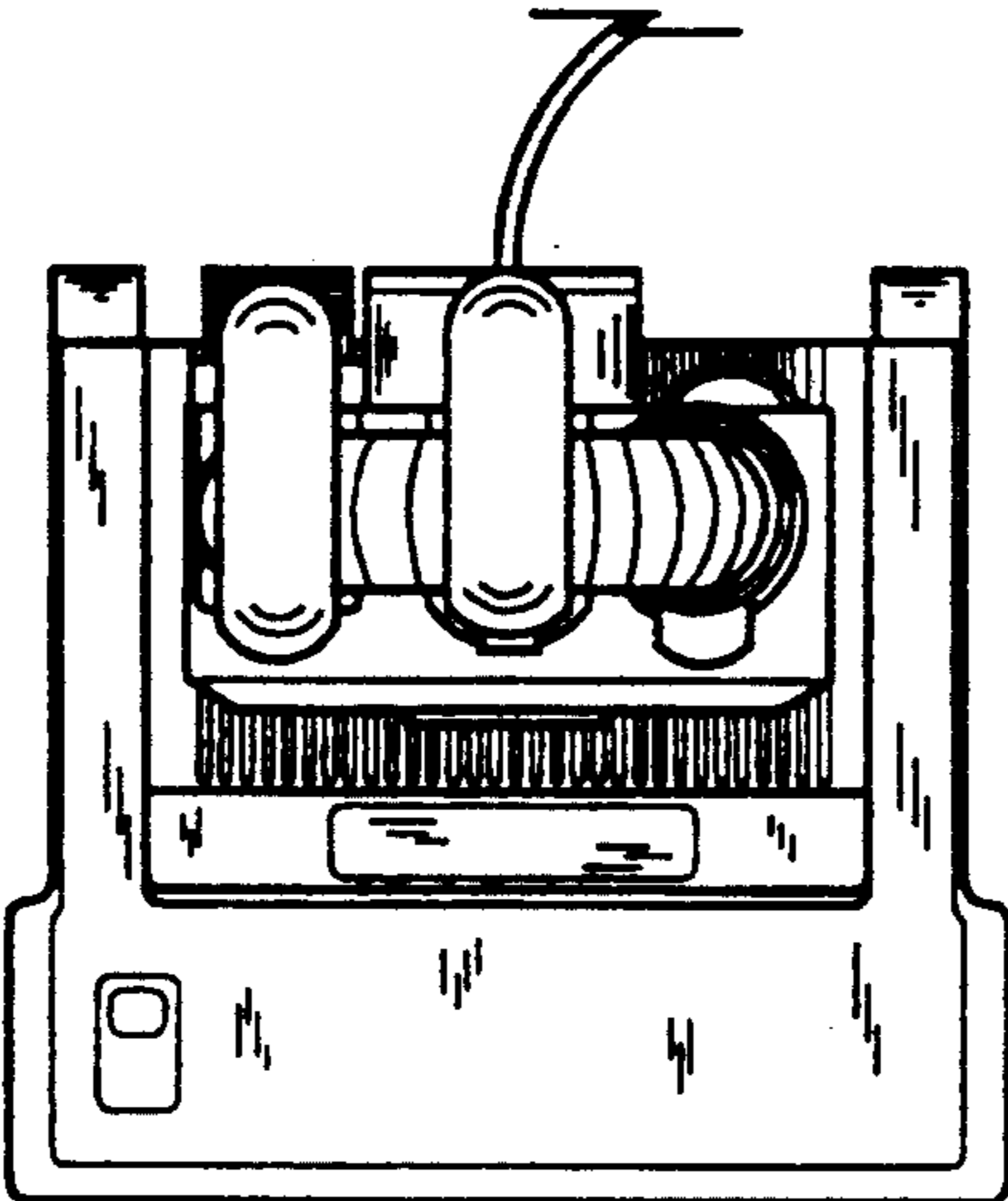

FIG. 19

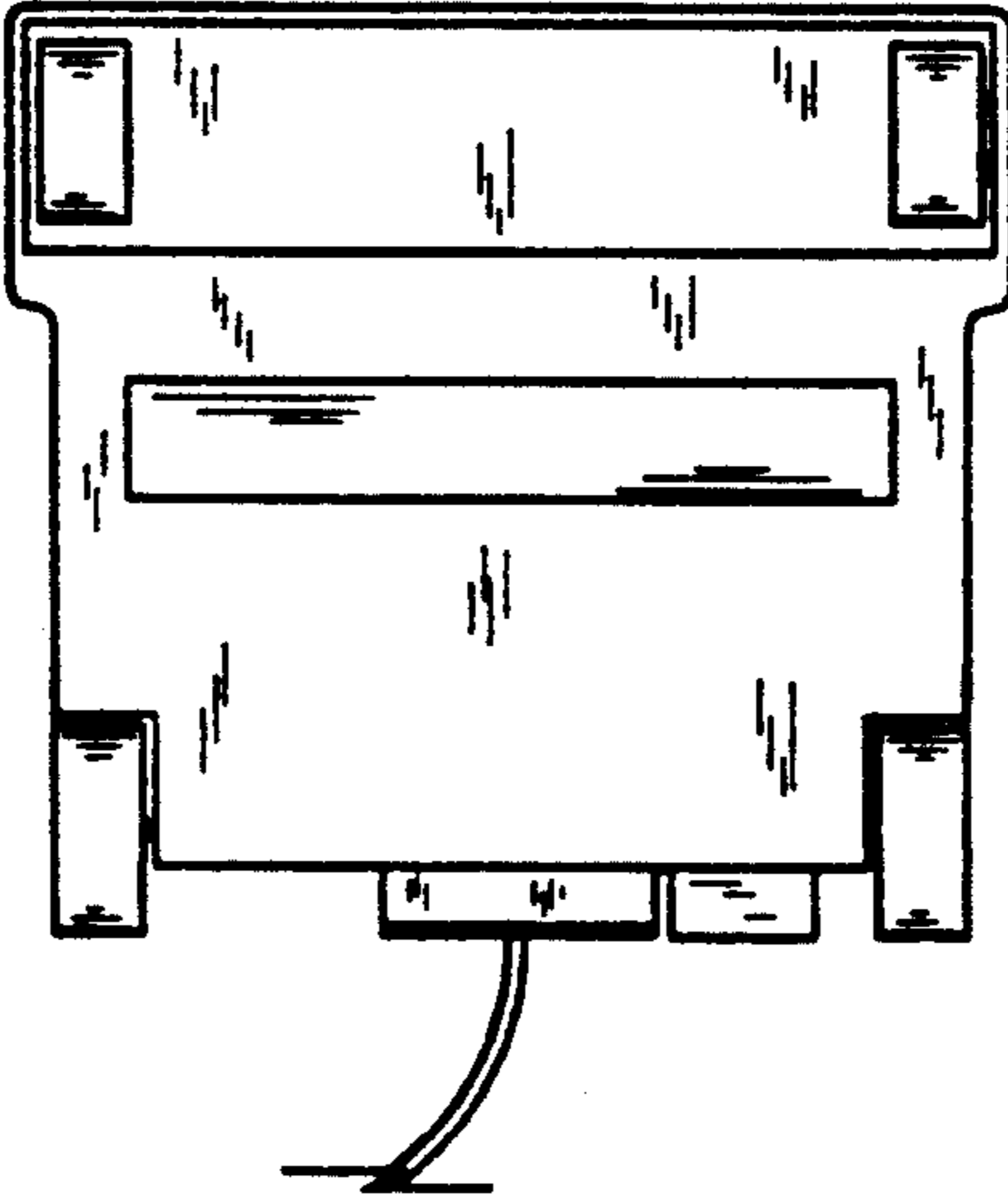

FIG. 20