



US00D339415S

United States Patent [19]

[11] Patent Number: **Des. 339,415**

Kiras

[45] Date of Patent: **** Sep. 14, 1993**

[54] **DRAIN GRATING**

[76] Inventor: **Chester A. Kiras**, 395 Springbank Ave., Unit 4, Woodstock, Ontario, Canada, N4T 1P8

[**] Term: **14 Years**

[21] Appl. No.: **731,031**

[22] Filed: **Jul. 16, 1991**

[30] **Foreign Application Priority Data**

Jan. 22, 1991 [CA] Canada 2201913

[52] U.S. Cl. **D23/397; D25/152**

[58] Field of Search **D25/156, 36; D23/397, D23/261; 210/163; 404/2, 4; 52/660-669, 209**

[56] **References Cited**

U.S. PATENT DOCUMENTS

D. 33,201	9/1900	Truesdell	D23/397
D. 263,511	3/1982	Bartscher	D25/156
D. 269,380	6/1983	d'Avila	D25/152
1,494,823	5/1924	Tappen	52/660

1,665,846	4/1928	Denni	52/660
2,701,027	2/1955	Scoville	404/4
4,367,142	1/1983	Blecher	404/2
4,515,498	5/1985	Thomann et al.	52/662
4,630,962	12/1986	Thomann et al.	404/2
4,940,359	7/1990	Van Duyn et al.	404/2
5,024,550	6/1991	Mainville	404/4

Primary Examiner—A. Hugo Word
Assistant Examiner—Doris Clark
Attorney, Agent, or Firm—R. Craig Armstrong

[57] **CLAIM**

The ornamental design for drain crating, as shown.

DESCRIPTION

FIG. 1 is a top, front, and right side perspective view of a drain grating, showing my new design;
FIG. 2 is a top plan view thereof;
FIG. 3 is a right side elevational view thereof;
FIG. 4 is an end elevational view thereof;
FIG. 5 is a bottom plan view thereof; and,
FIG. 6 is a top, front, and right side perspective view of a variant thereof.

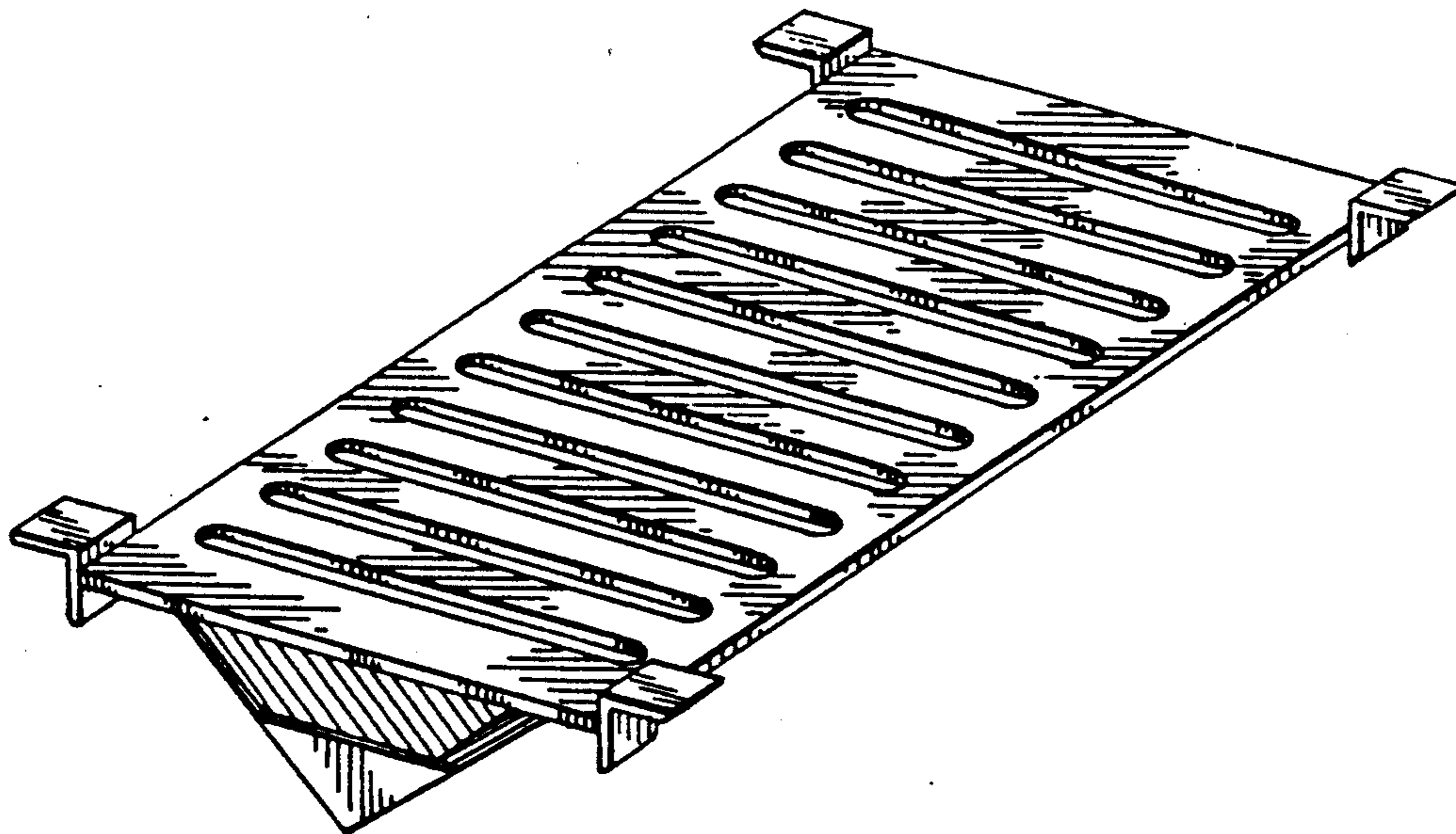

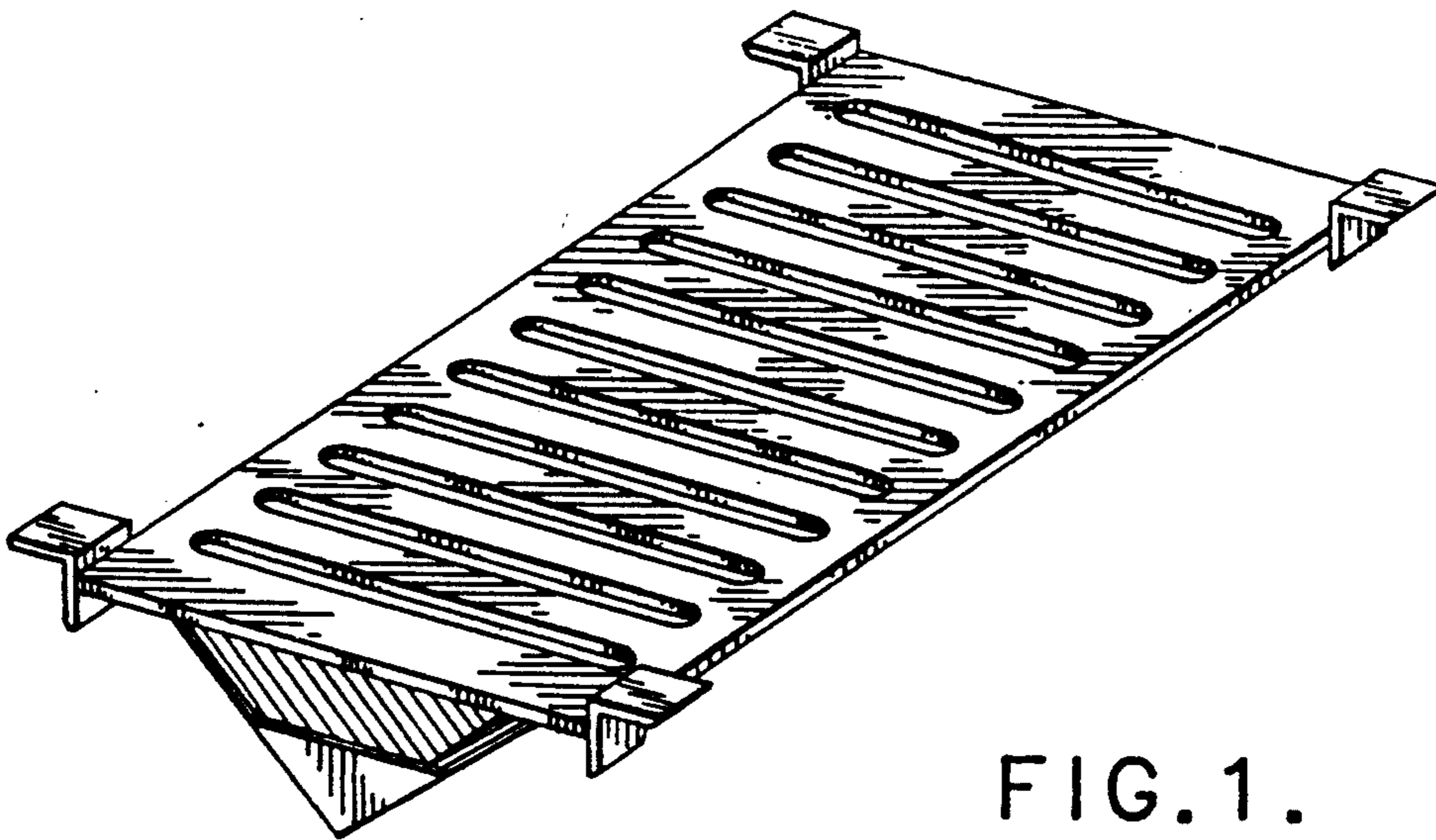

FIG. 1.

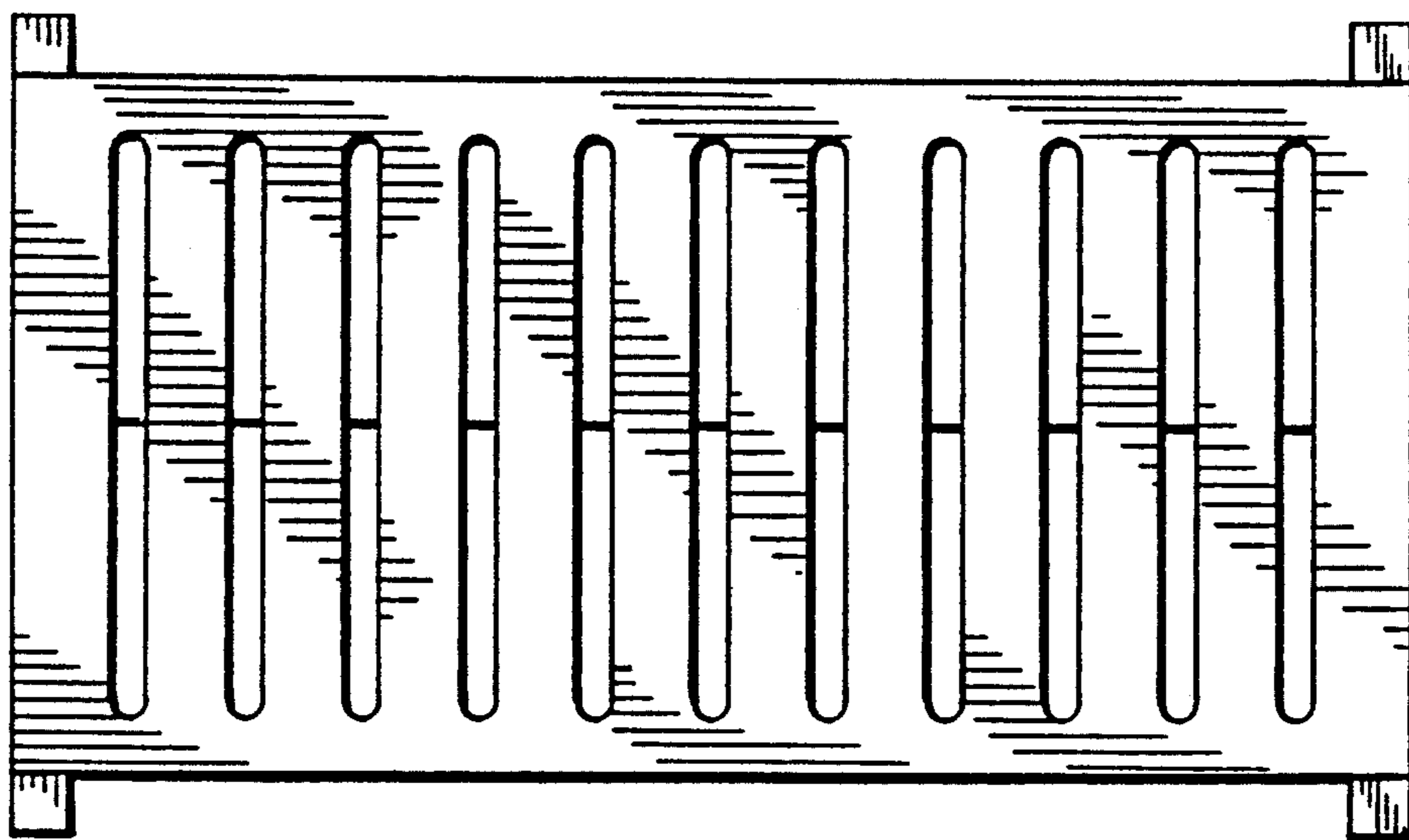

FIG. 2.

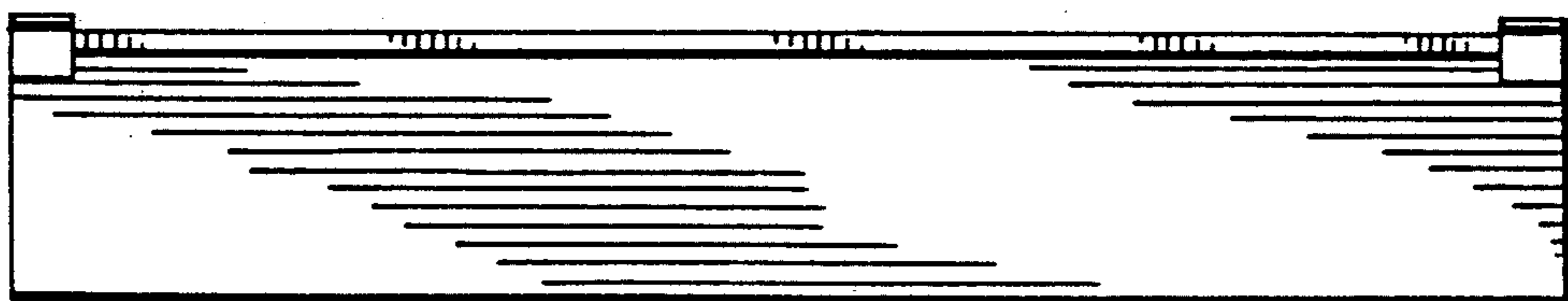

FIG. 3.

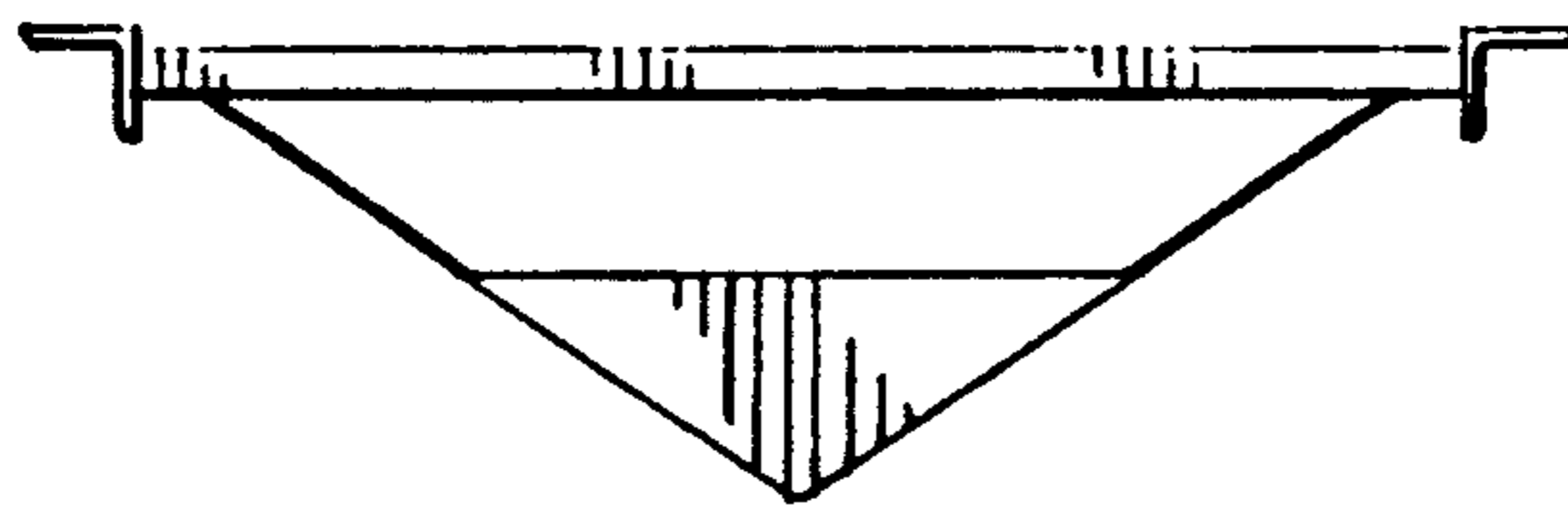

FIG. 4.

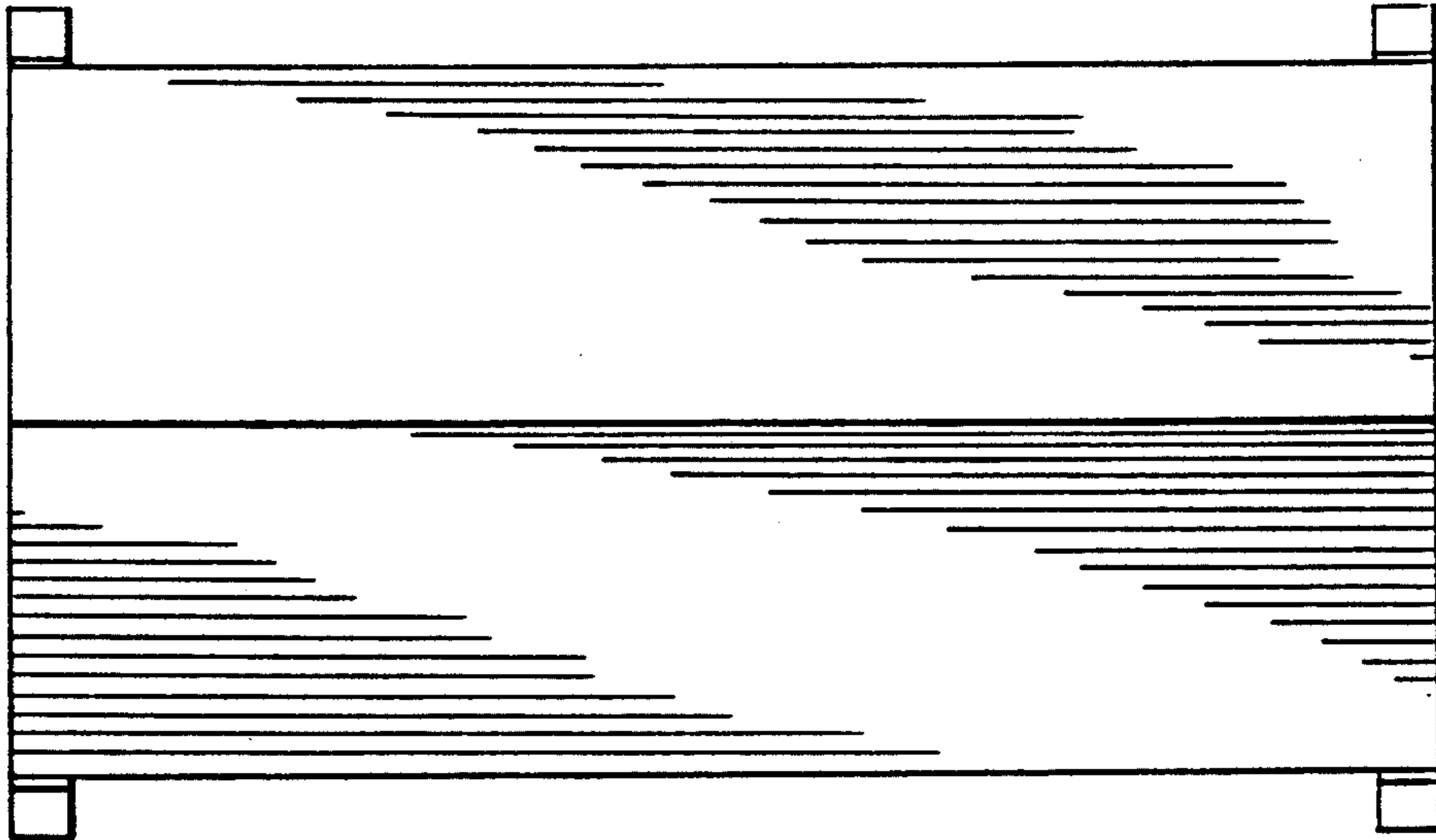

FIG. 5.

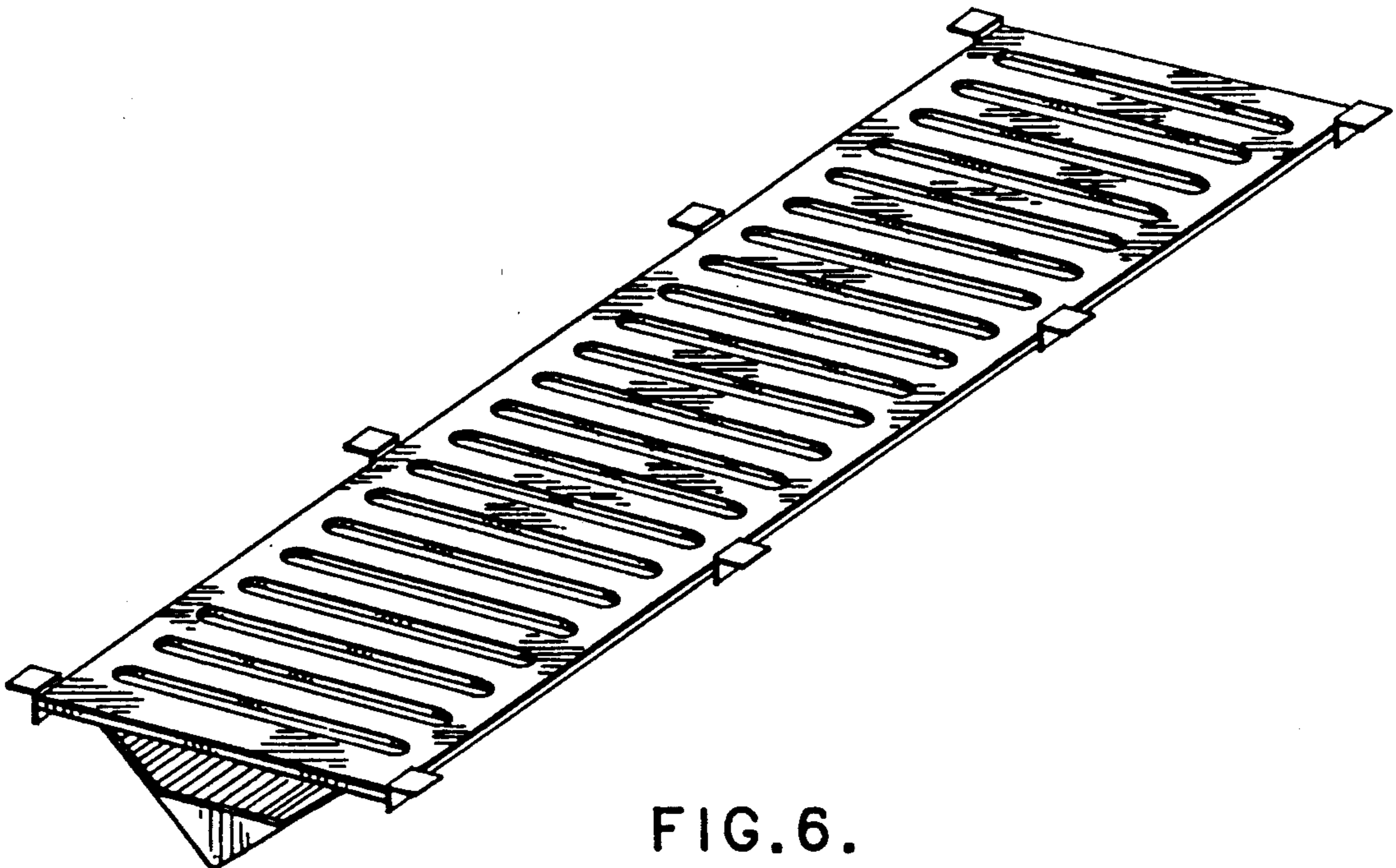

FIG. 6.