



US00D339409S

# United States Patent [19]

[11] Patent Number: **Des. 339,409**

Jans

[45] Date of Patent: **\*\* Sep. 14, 1993**

[54] FAUCET

[57] CLAIM

[75] Inventor: **Franz W. Jans**, Roedermark, Fed. Rep. of Germany

The ornamental design for a faucet, as shown and described.

[73] Assignee: **JADO Bathroom and Hardware Manufacturing Corp.**, Camarillo, Calif.

### DESCRIPTION

[\*\*] Term: **14 Years**

FIG. 1 is a perspective view of a faucet showing my new design;

[21] Appl. No.: **812,980**

FIG. 2 is a left side elevational view thereof;

[22] Filed: **Dec. 19, 1991**

FIG. 3 is a front elevational view thereof;

[52] U.S. Cl. .... **D23/238**

FIG. 4 is a right side elevational view thereof;

[58] Field of Search ..... **D23/238-243, D23/250, 225; 4/675-678; 137/625.17, 180**

FIG. 5 is a rear elevational view thereof;

FIG. 6 is a top plan view thereof;

FIG. 7 is a bottom plan view thereof;

FIG. 8 is a perspective view of a second embodiment thereof;

FIG. 9 is a left side elevational view of FIG. 7;

FIG. 10 is a front elevational view of FIG. 7;

FIG. 11 is a right side elevational view of FIG. 7;

FIG. 12 is a rear elevational view of FIG. 7;

FIG. 13 is a top plan view of FIG. 7;

FIG. 14 is a bottom plan view of FIG. 7;

FIG. 15 is a perspective view of a third embodiment thereof;

FIG. 16 is a left side elevational view of FIG. 15;

FIG. 17 is a front elevational view of FIG. 15;

FIG. 18 is a right side elevational view of FIG. 15;

FIG. 19 is a rear elevational view of FIG. 15;

FIG. 20 is a top plan view of FIG. 15;

FIG. 21 is a bottom plan view of FIG. 15;

FIG. 22 is a perspective view of a fourth embodiment thereof;

FIG. 23 is a left side elevational view of FIG. 22;

FIG. 24 is a front elevational view of FIG. 22;

FIG. 25 is a right side elevational view of FIG. 22;

FIG. 26 is a rear elevational view of FIG. 22;

FIG. 27 is a top plan view of view of FIG. 22; and,

FIG. 28 is a bottom plan view of FIG. 22.

### [56] References Cited

#### U.S. PATENT DOCUMENTS

D. 113,398	2/1939	Reinecke	.....	D23/238
D. 220,101	3/1971	Brown et al.	.....	D23/238
D. 227,762	7/1973	Arbon	.....	D23/238
D. 291,232	8/1987	Haug et al.	.....	D23/238
D. 291,234	8/1987	Bergmann et al.	.....	D23/238
D. 291,235	8/1987	Bergmann et al.	.....	D23/238
D. 292,607	11/1987	Wu	.....	D23/238
D. 301,162	5/1989	Oberdorfer	.....	D23/238
D. 317,646	6/1991	Yost	.....	D23/252
D. 321,038	10/1991	Delepine	.....	D23/238
D. 324,095	2/1992	Grohe	.....	D23/238
D. 324,725	3/1992	Lang et al.	.....	D23/252
D. 333,340	2/1993	Chretien	.....	D23/238

Primary Examiner—James R. Largen

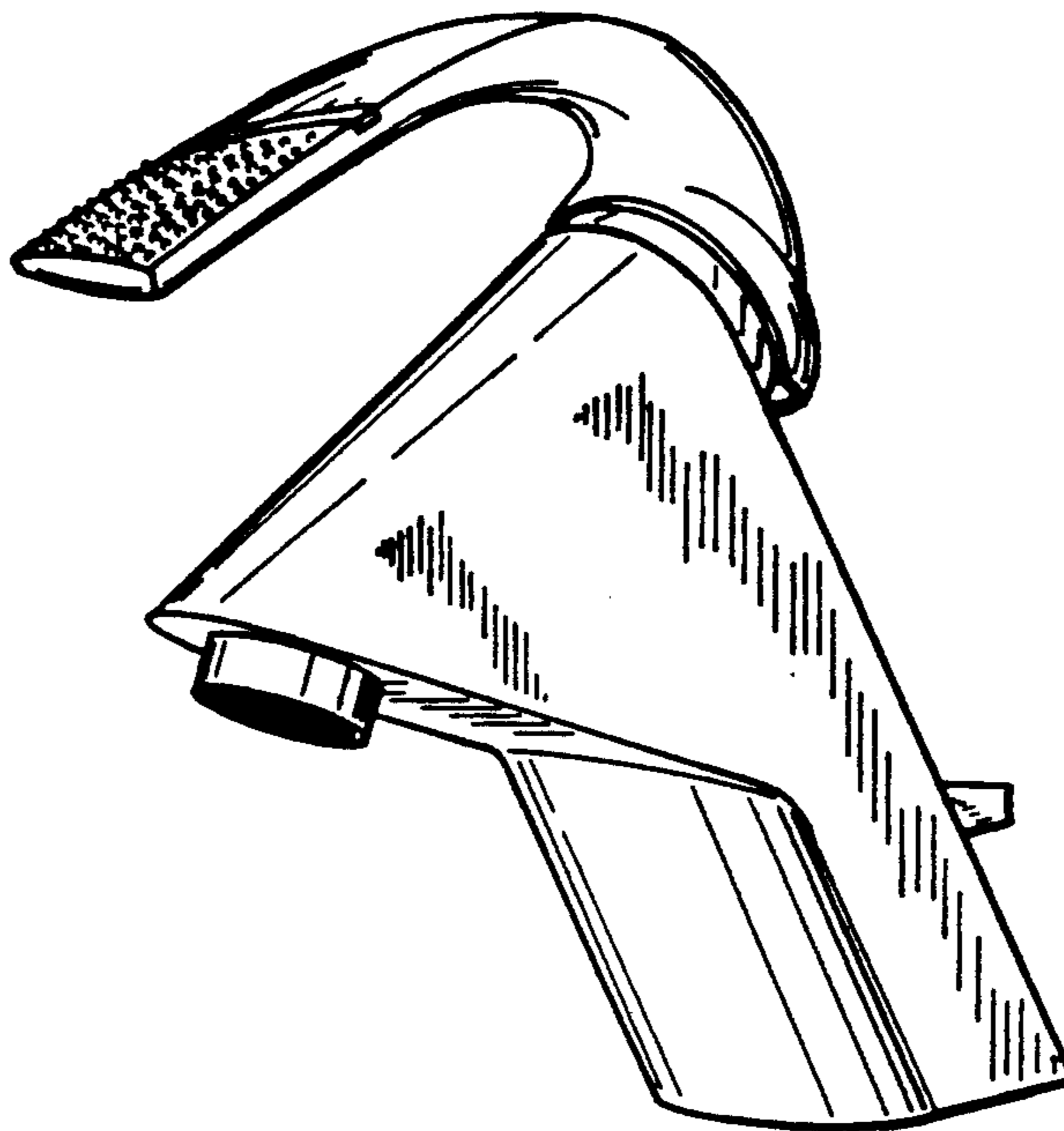

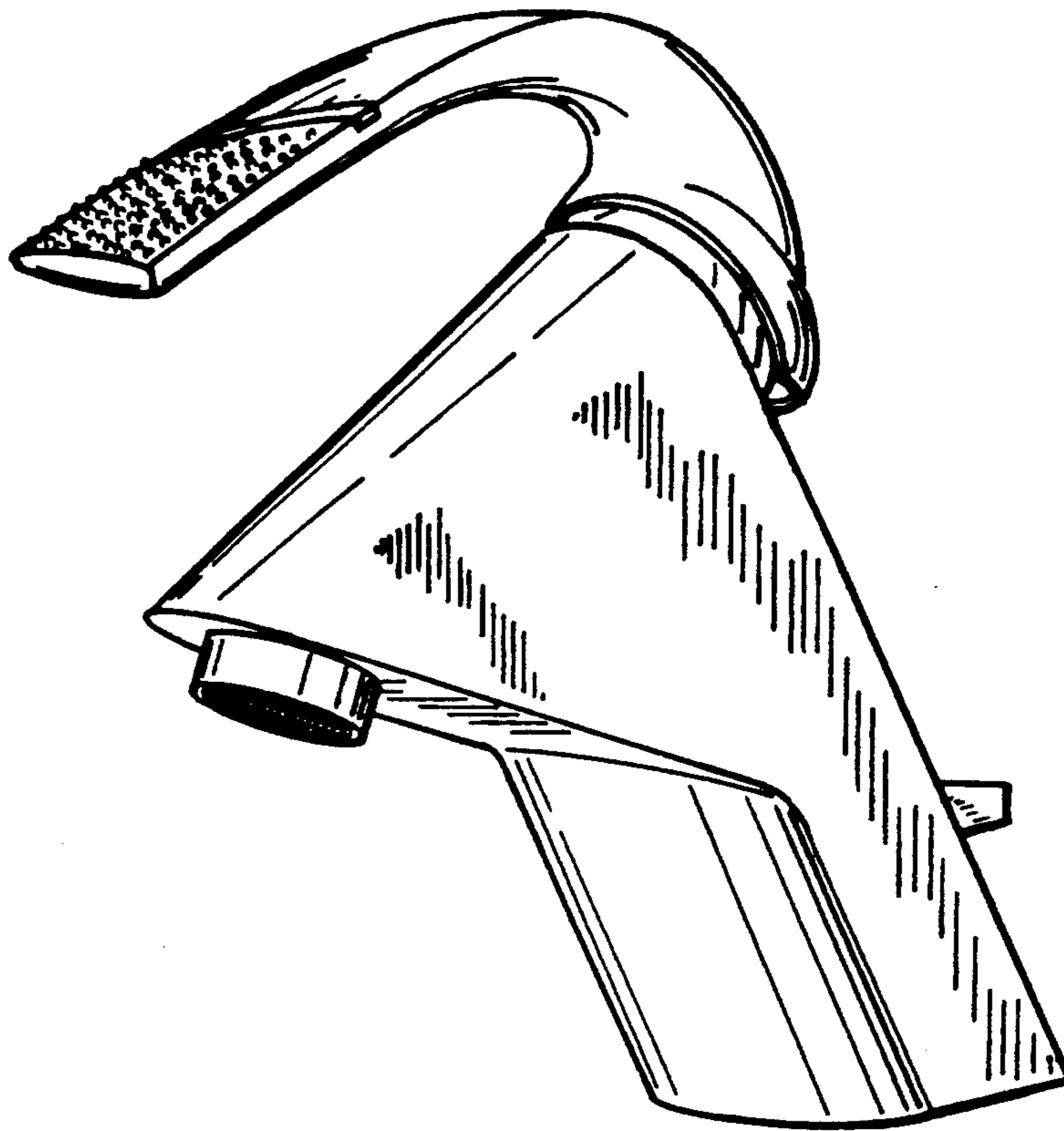

*FIG. 1*

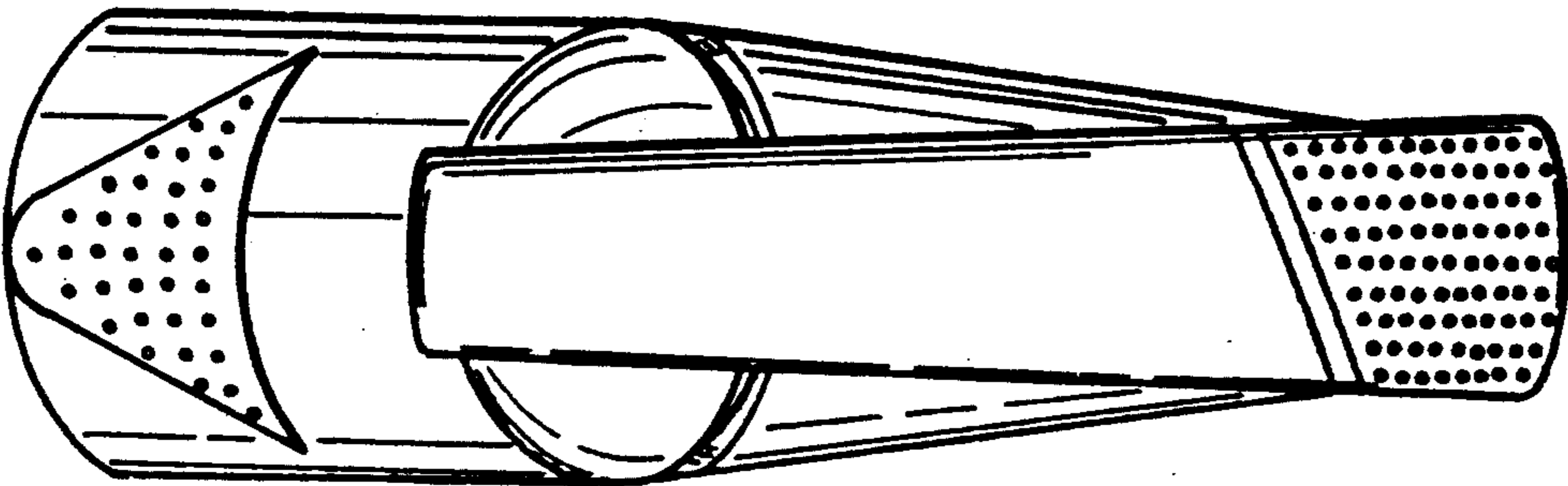

FIG.-6

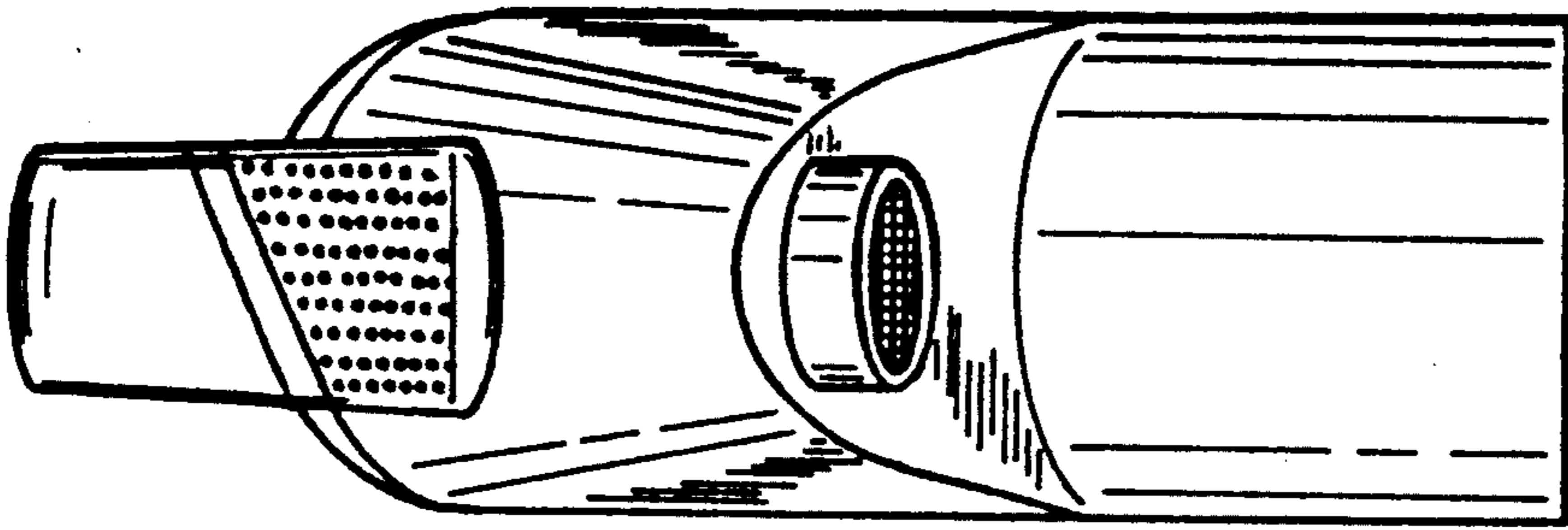

FIG.-3

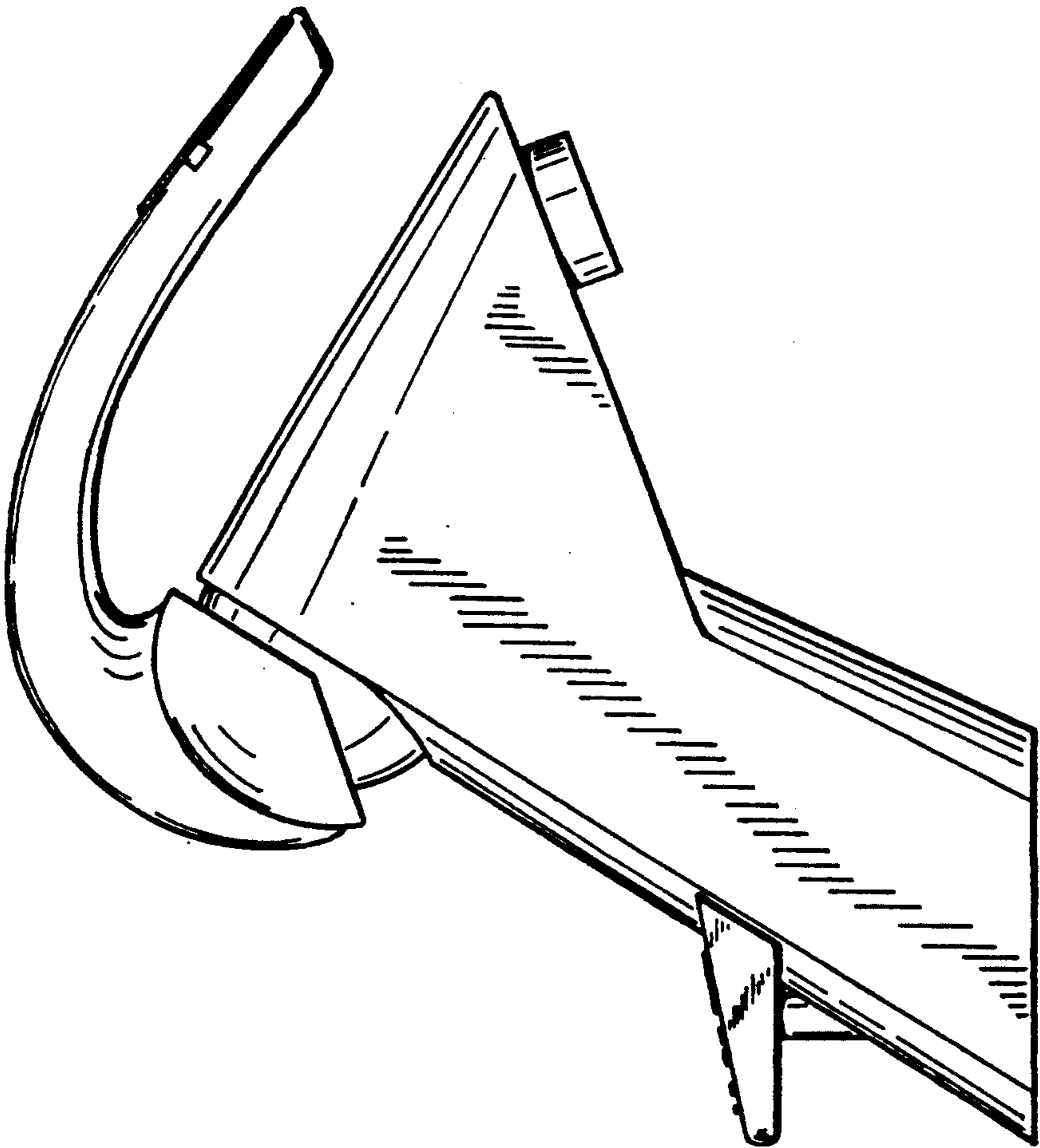

FIG.-2

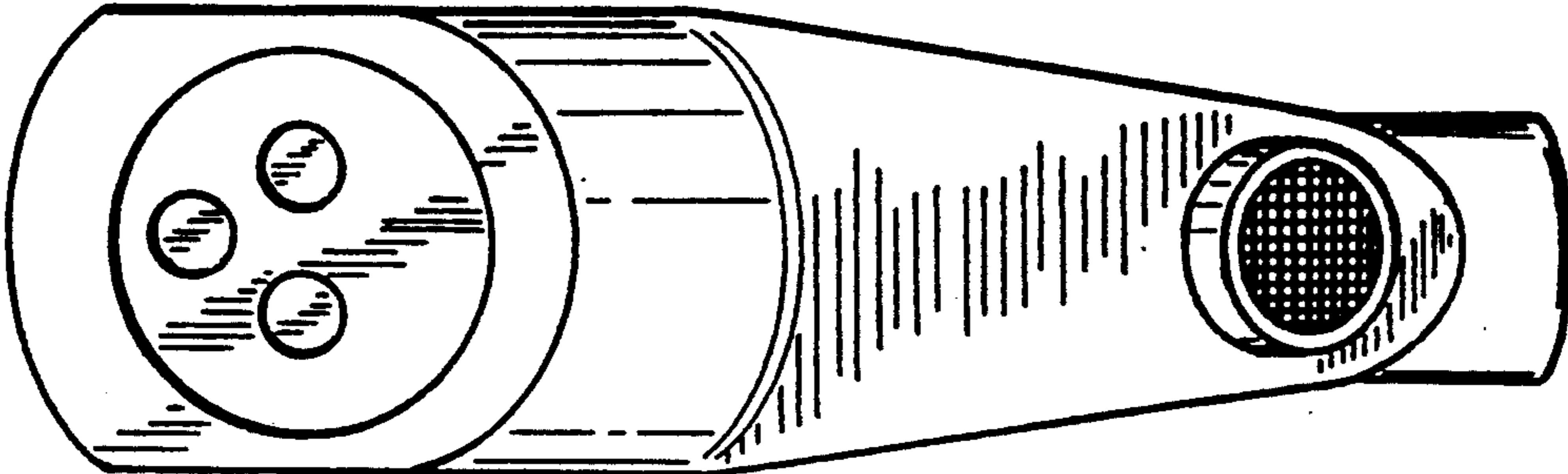

FIG.- 7

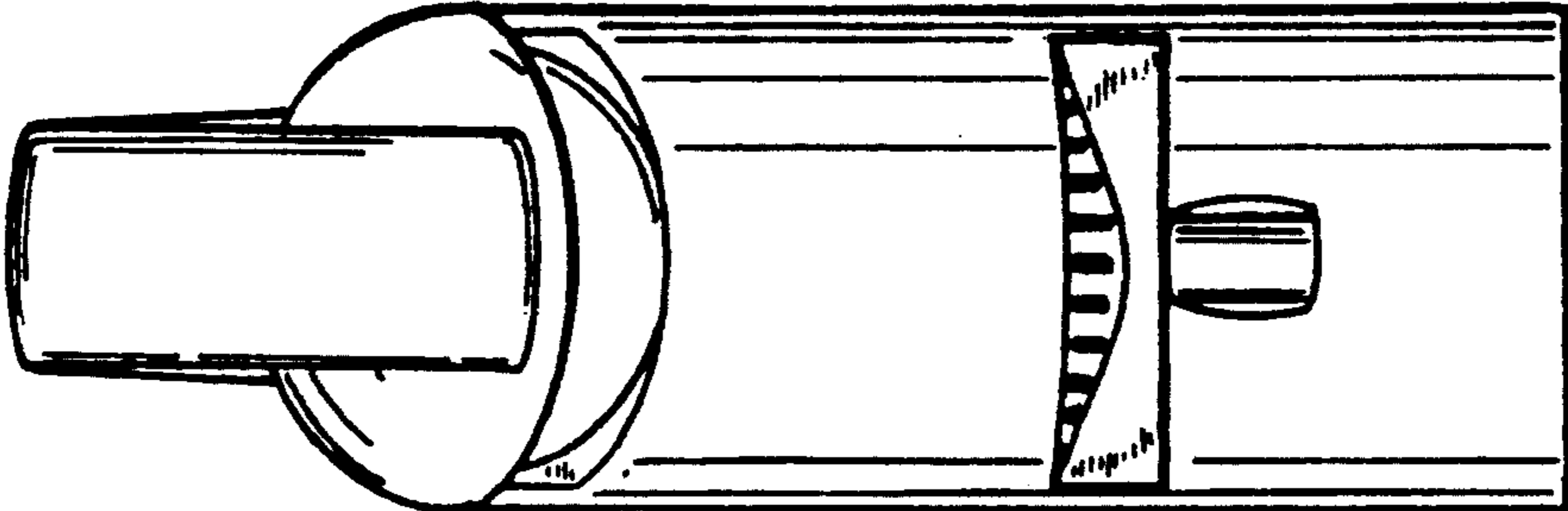

FIG.- 5

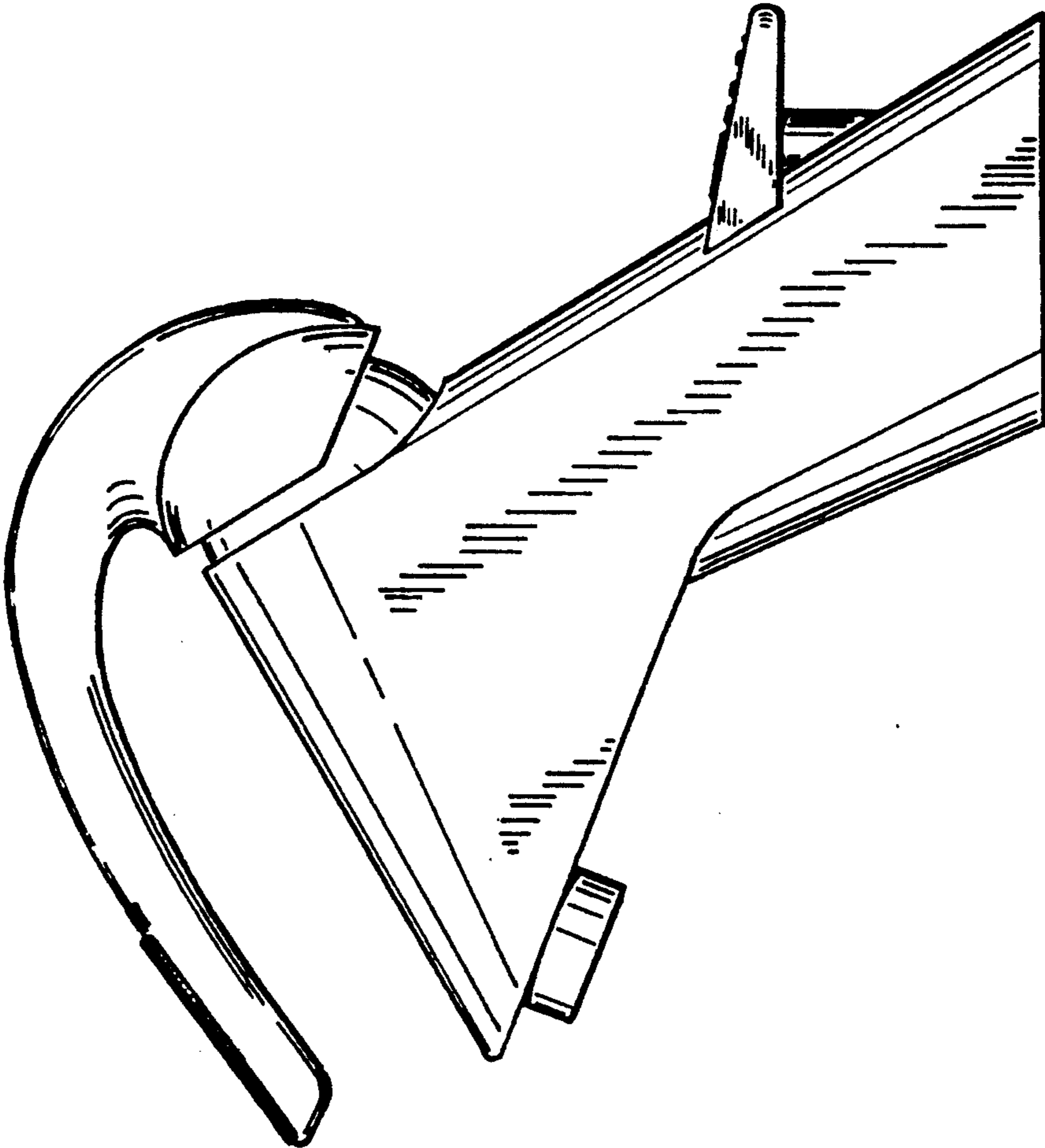
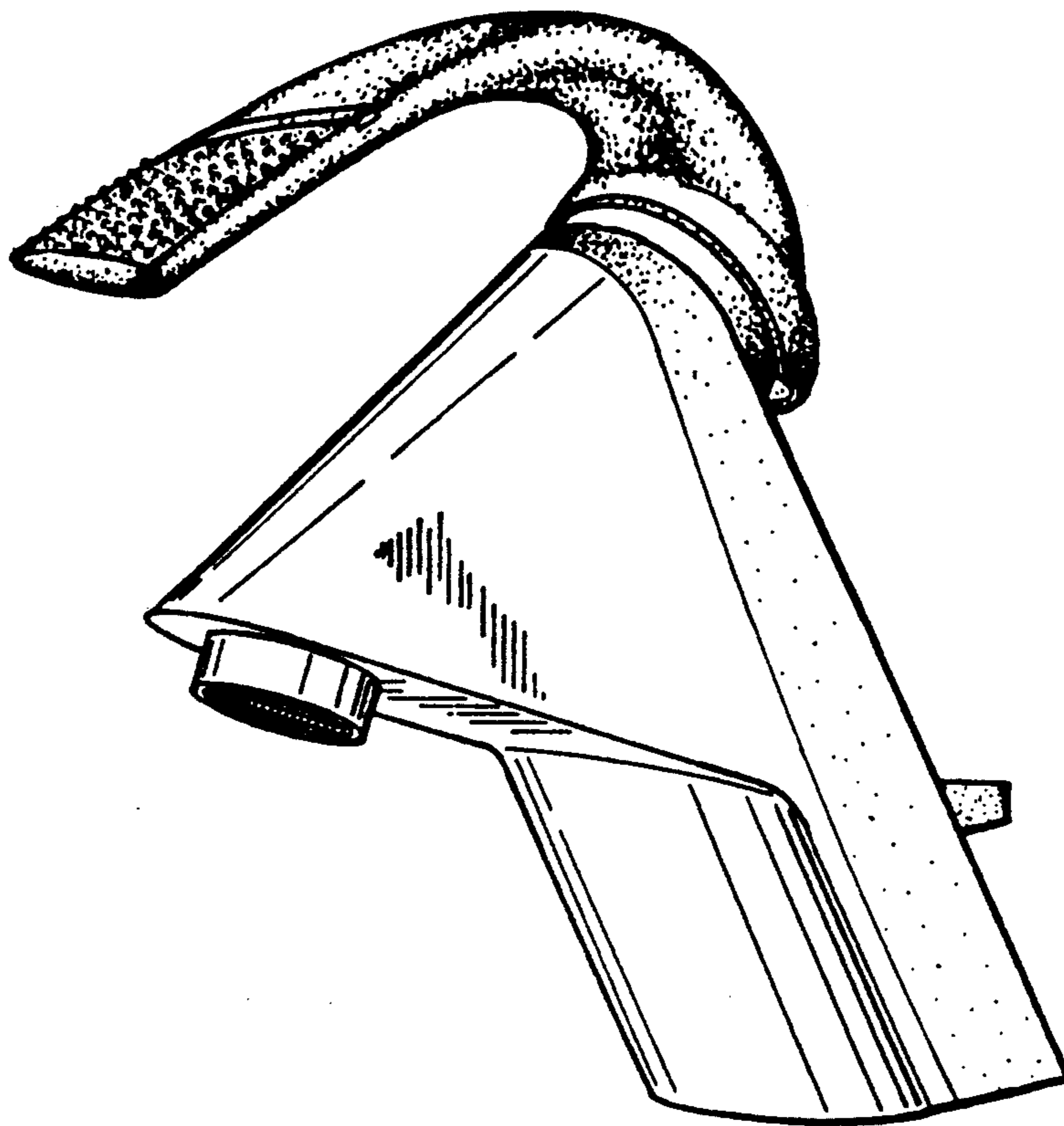

FIG.- 4



**FIG. 8**

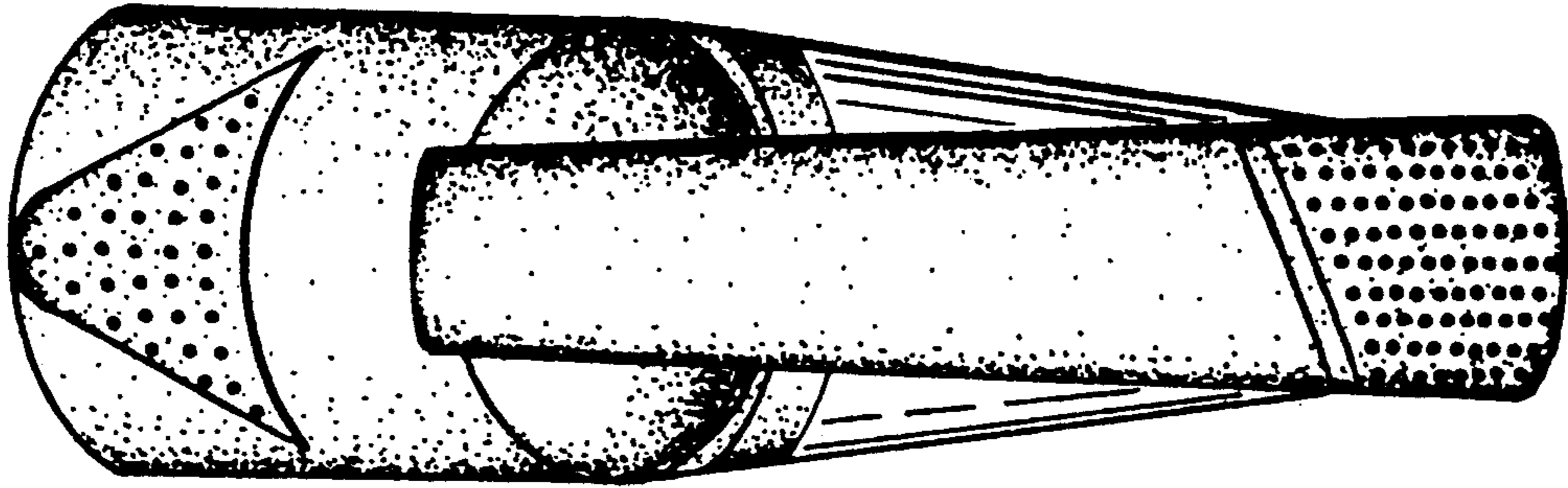

FIG. 13

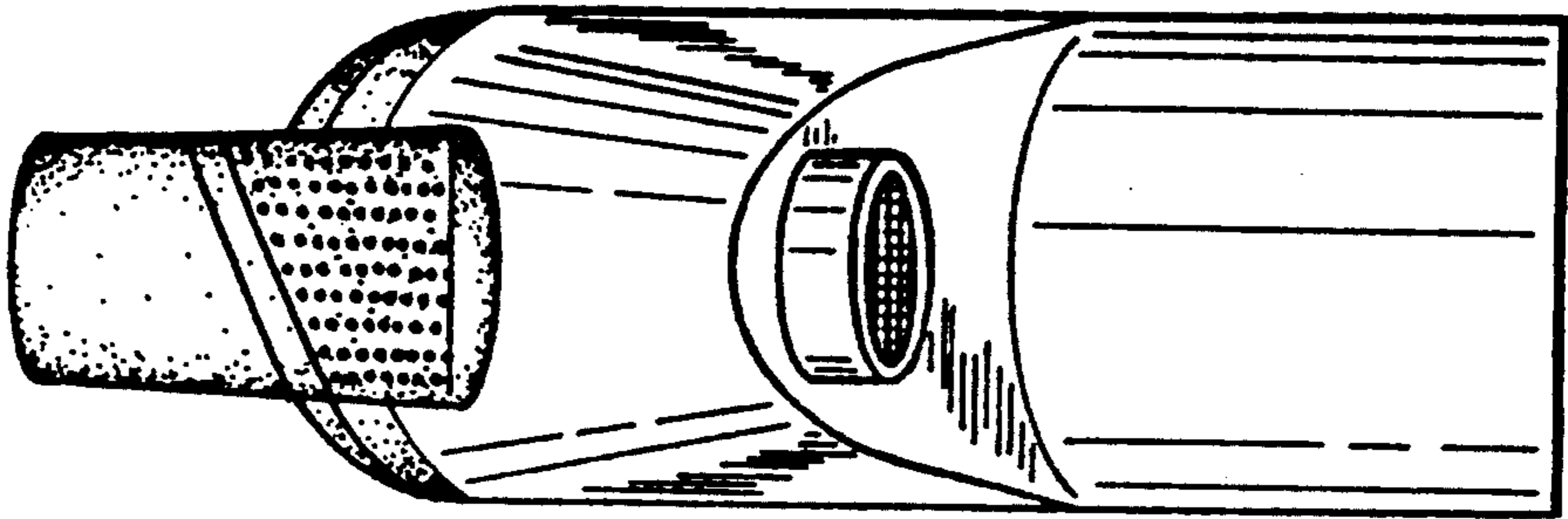

FIG. 10

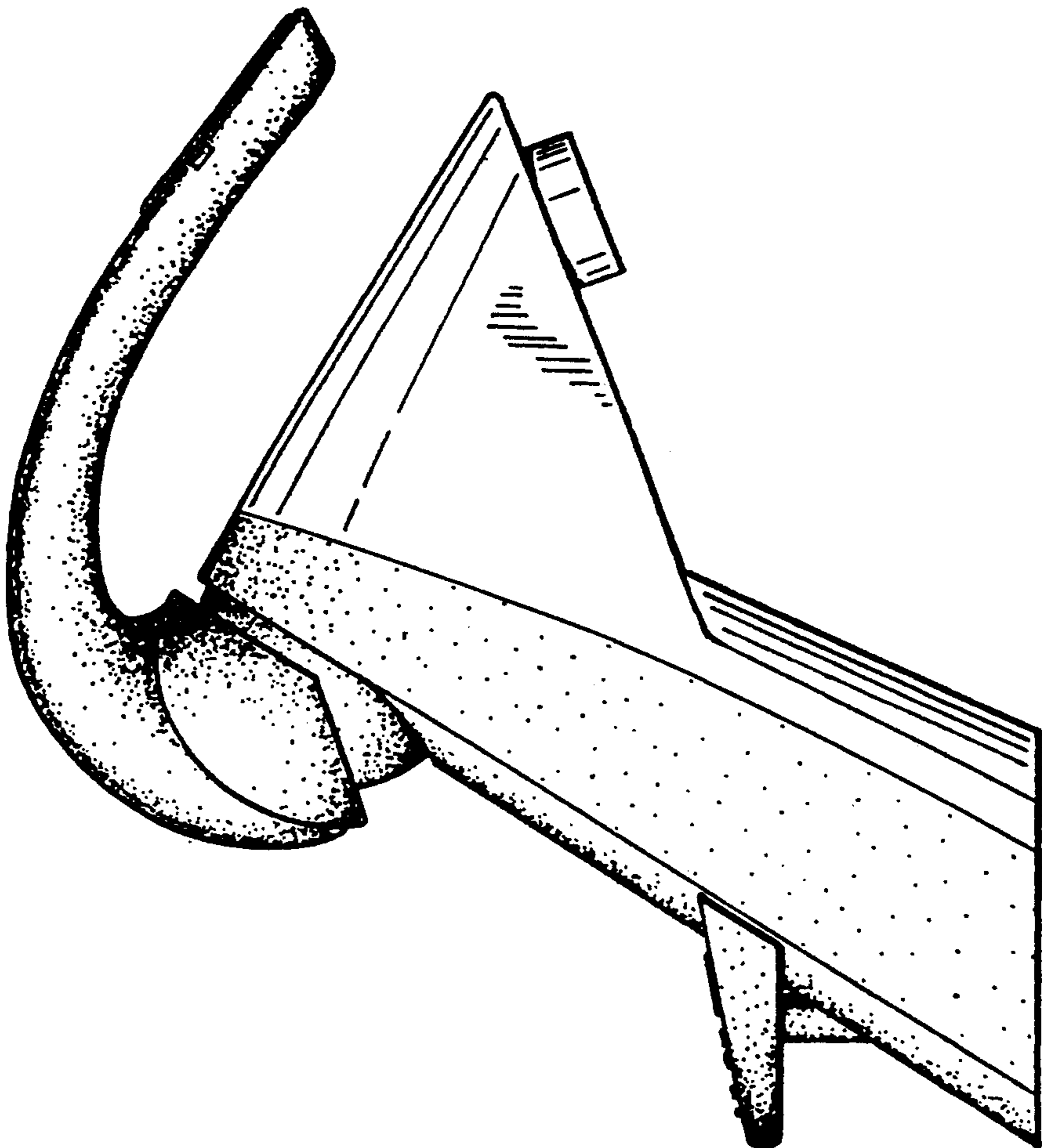

FIG. 9

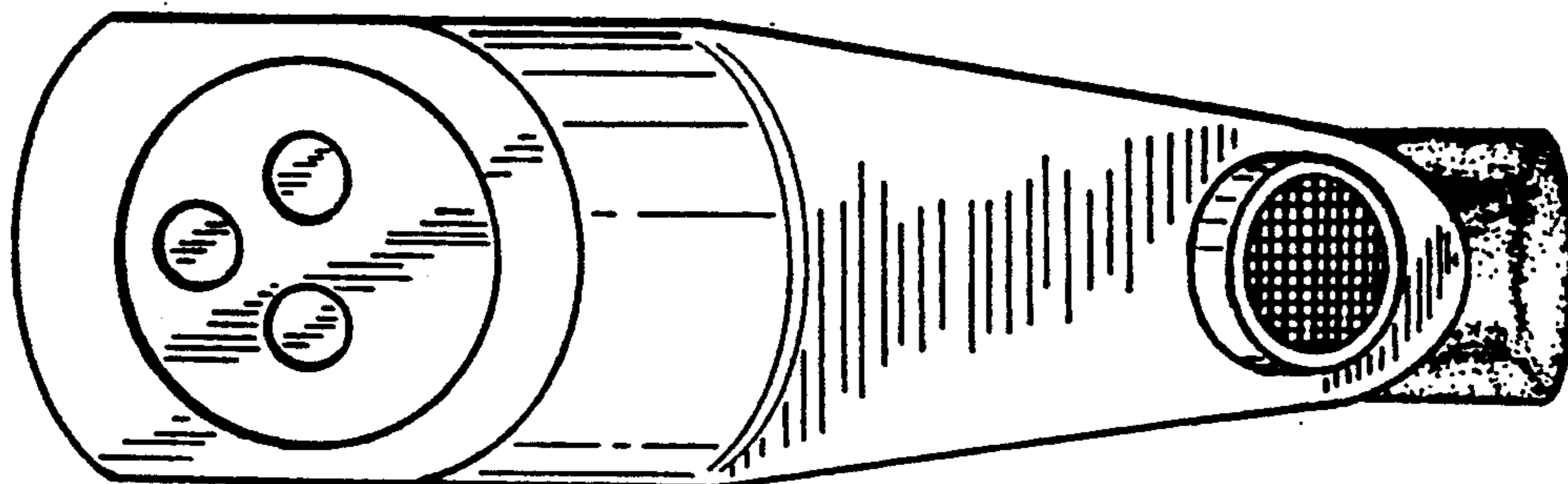

FIG.-14

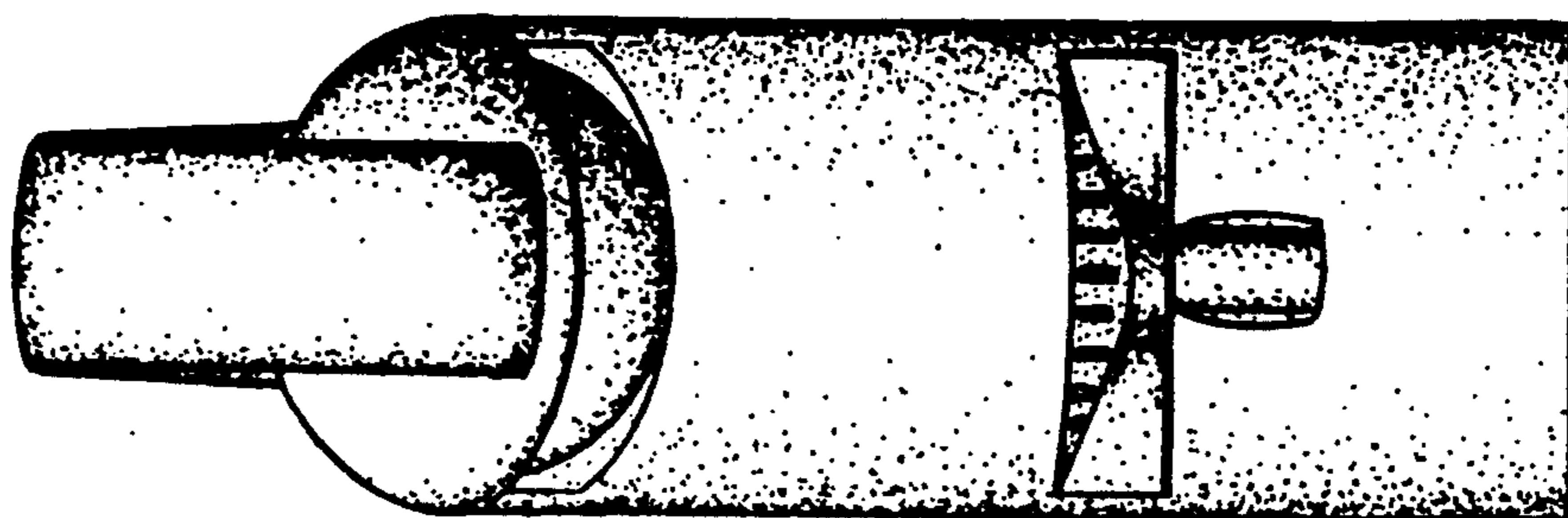

FIG.-12

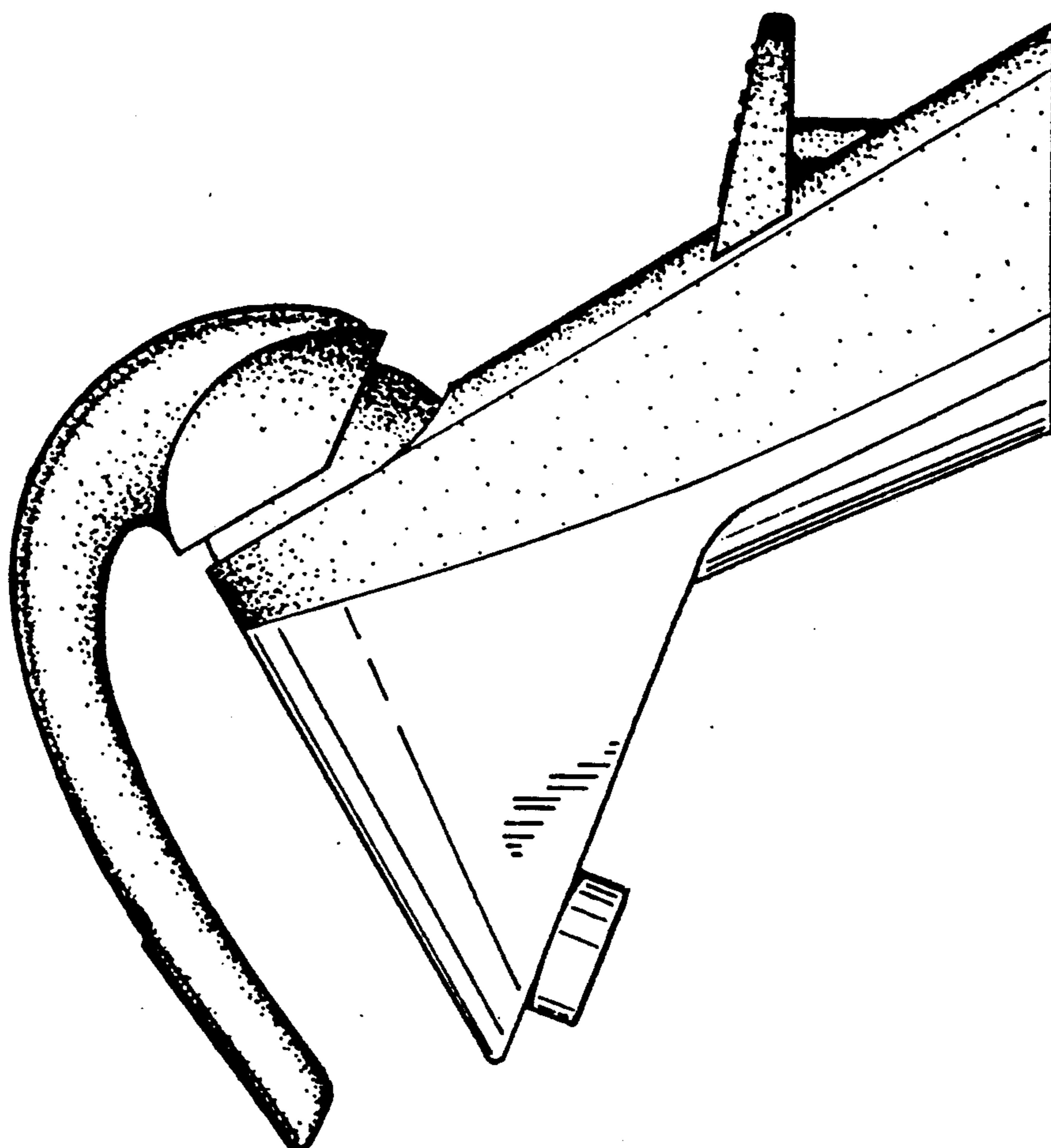
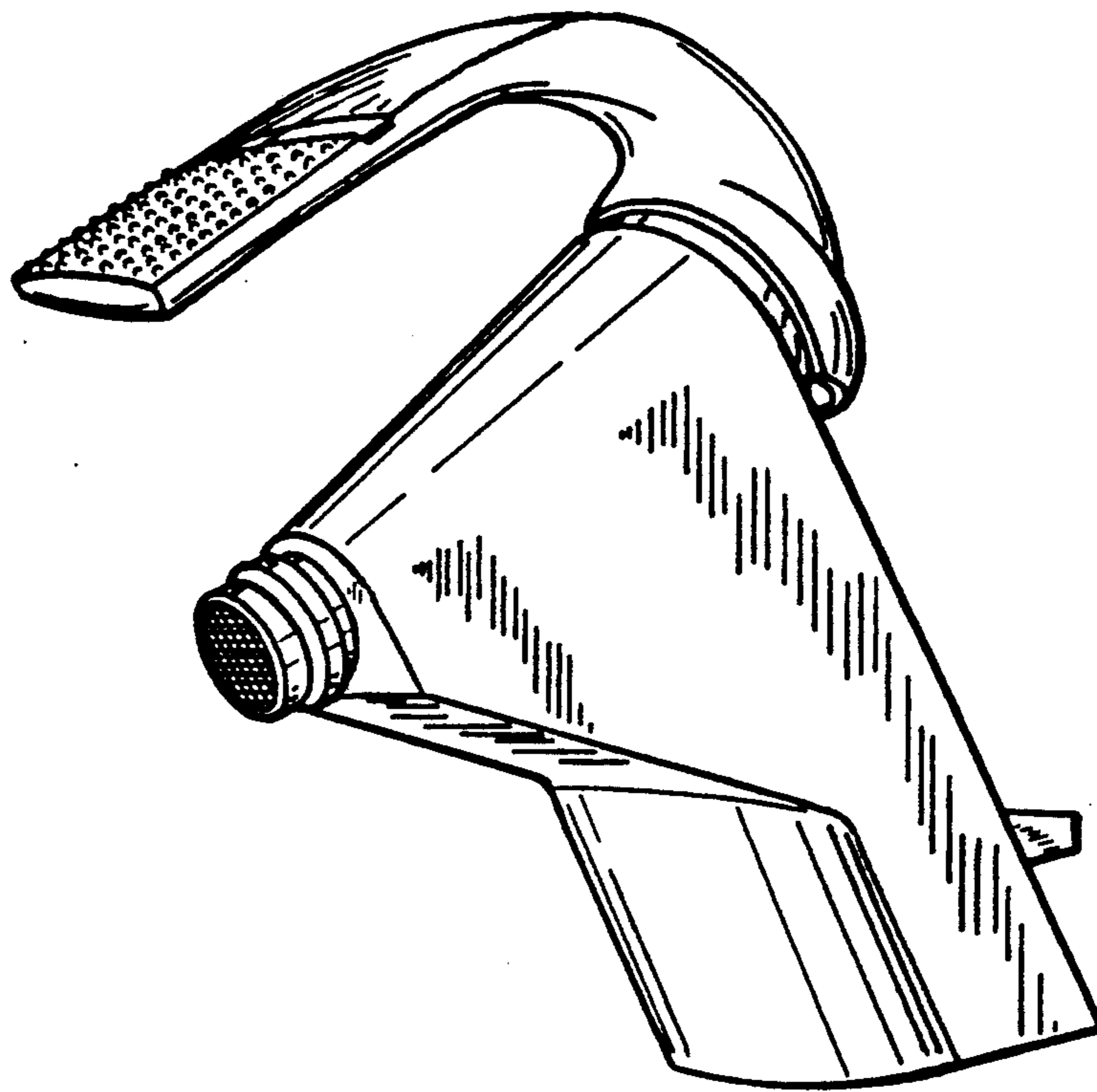

FIG.-11



**FIG. 15**



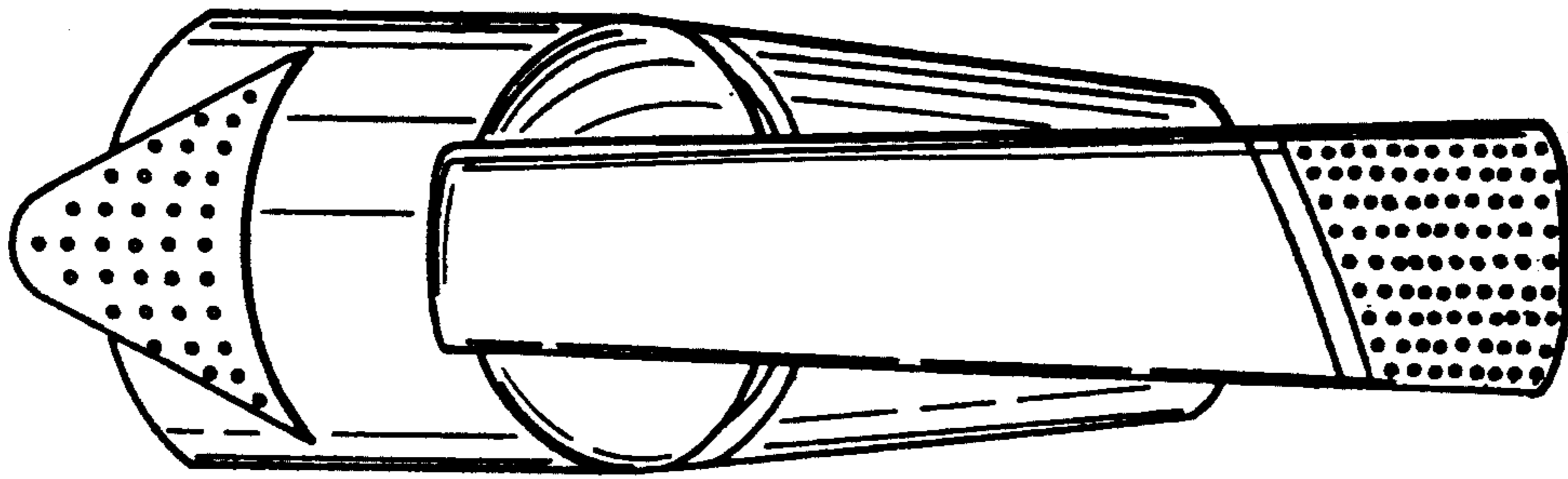

FIG.-20

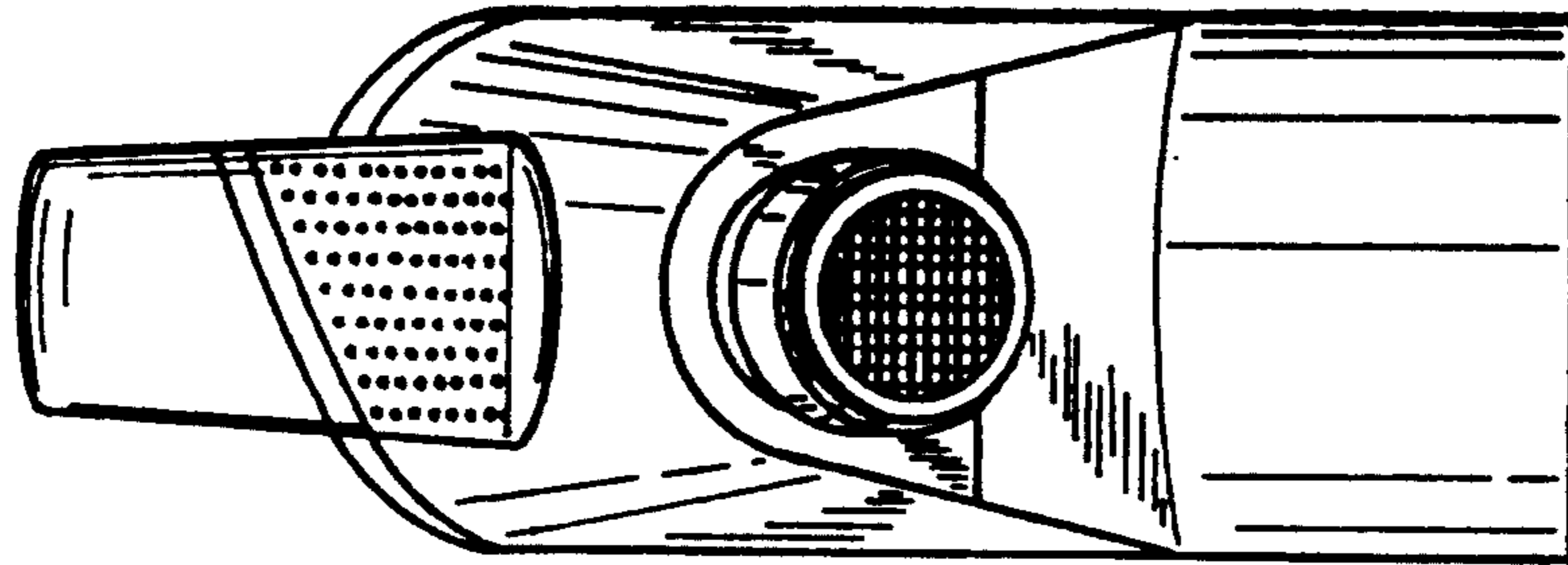

FIG.-17

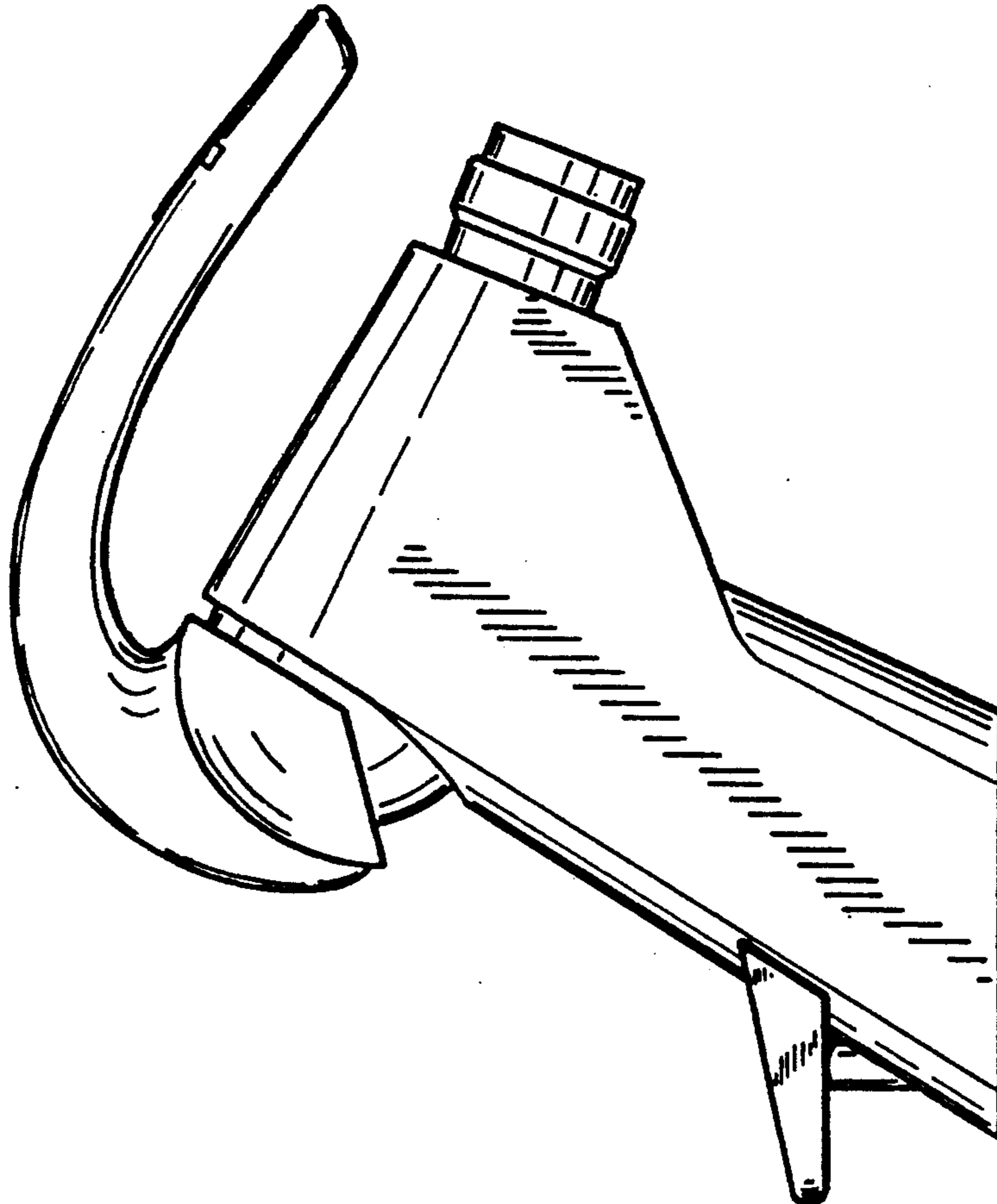

FIG.-16

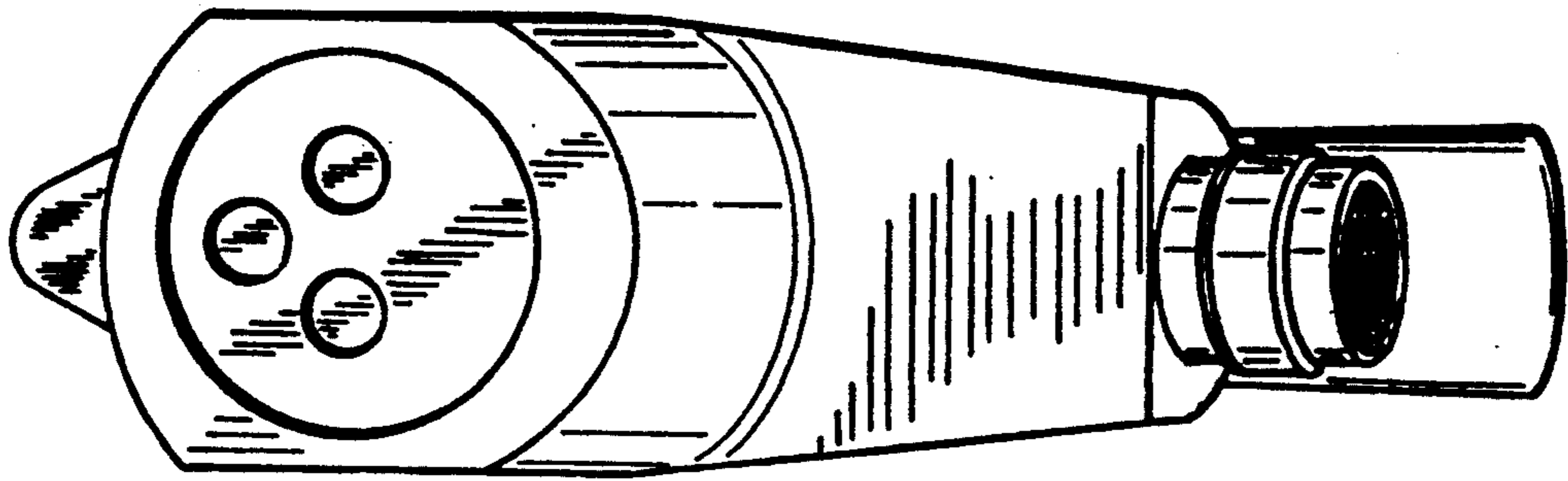

FIG.-21

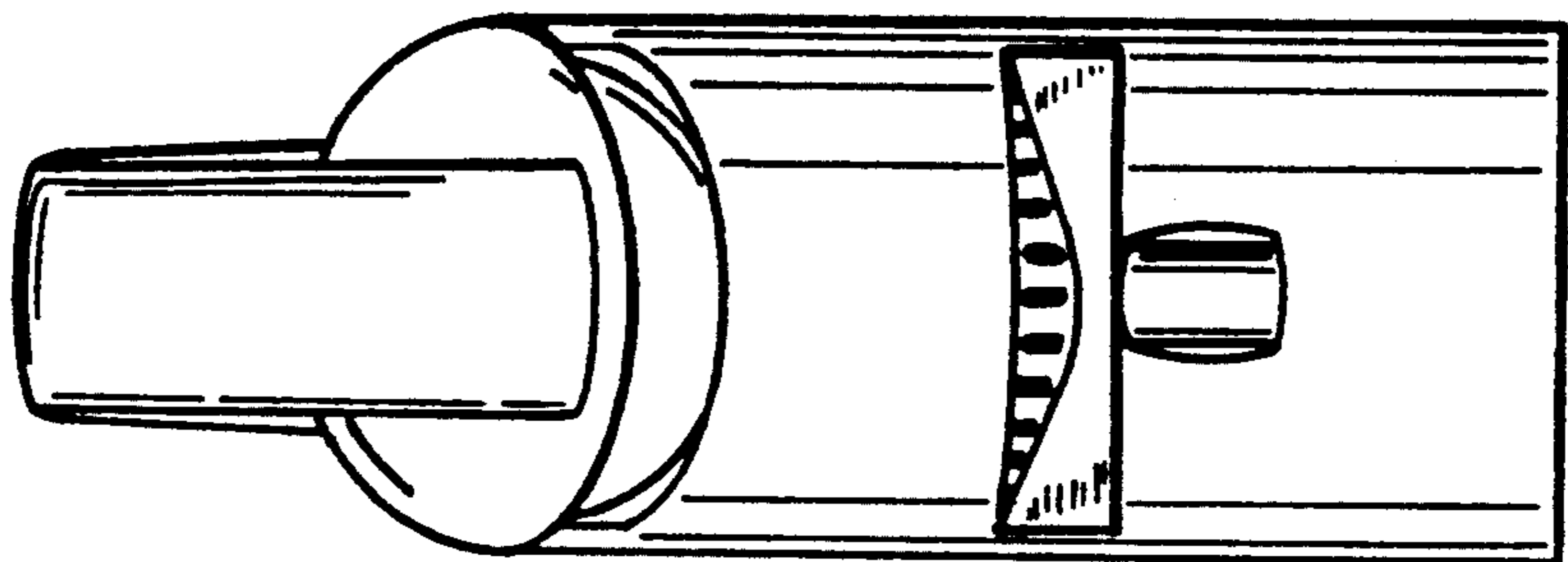

FIG.-19

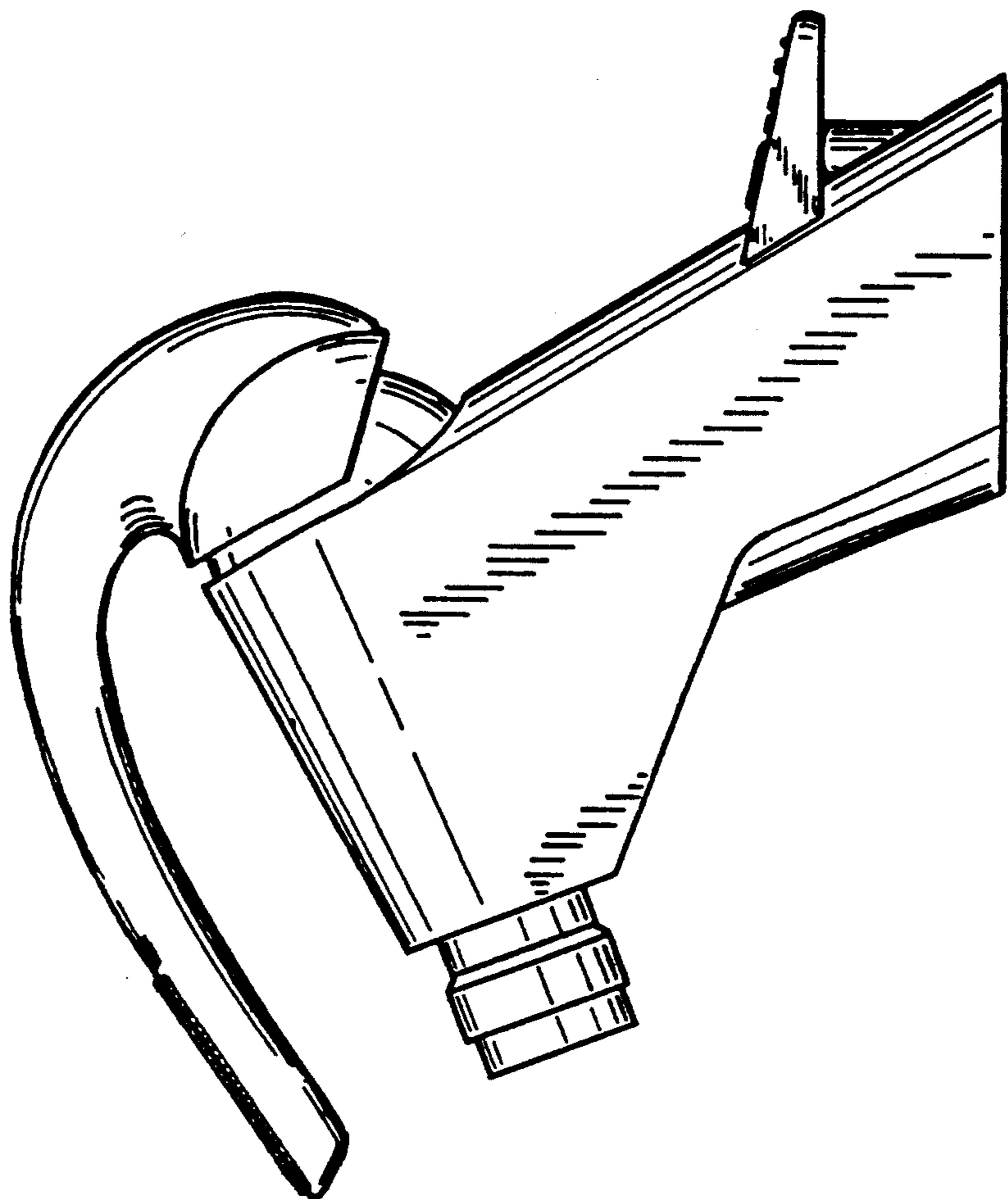
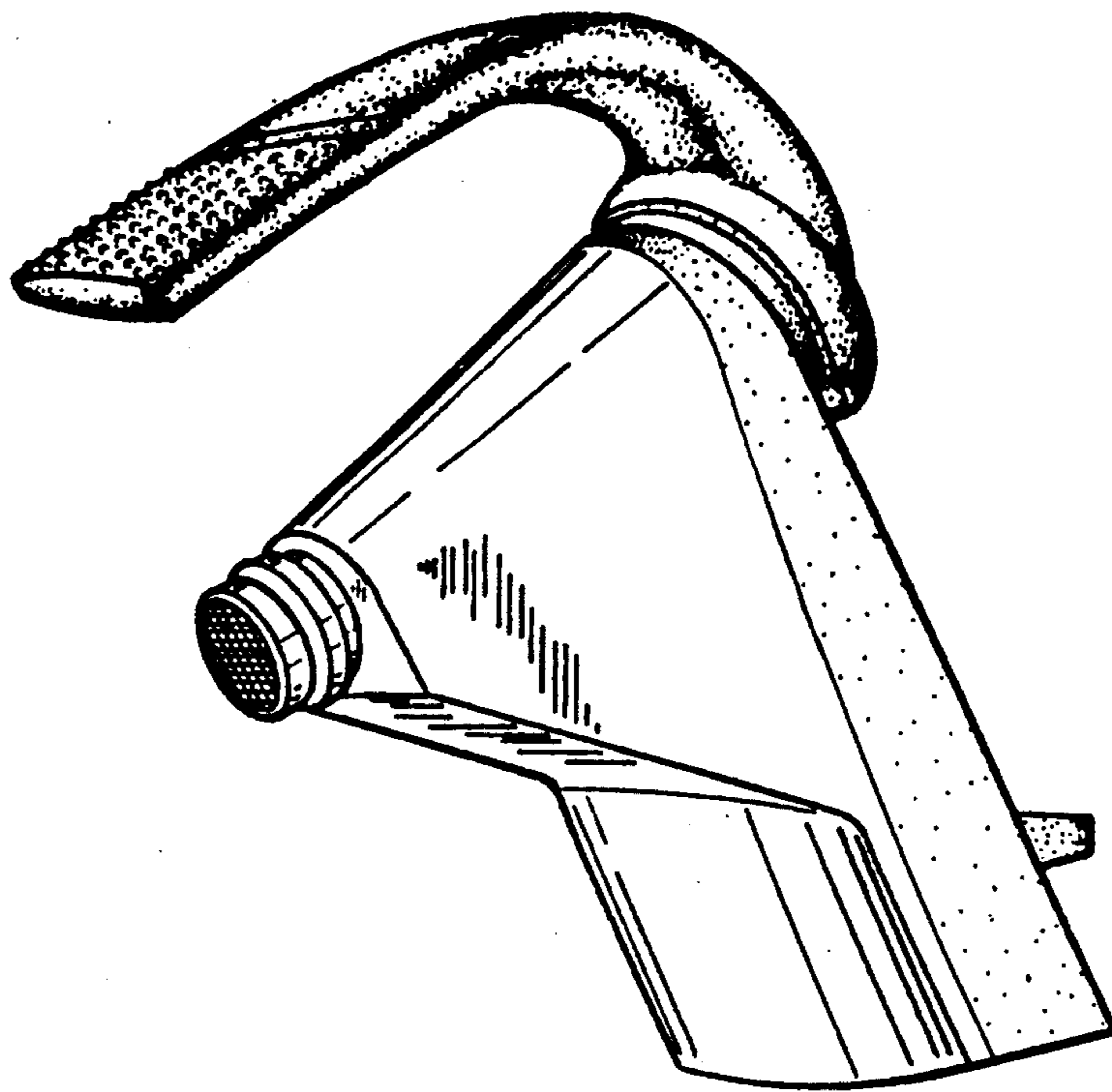

FIG.-18



*FIG. 22*

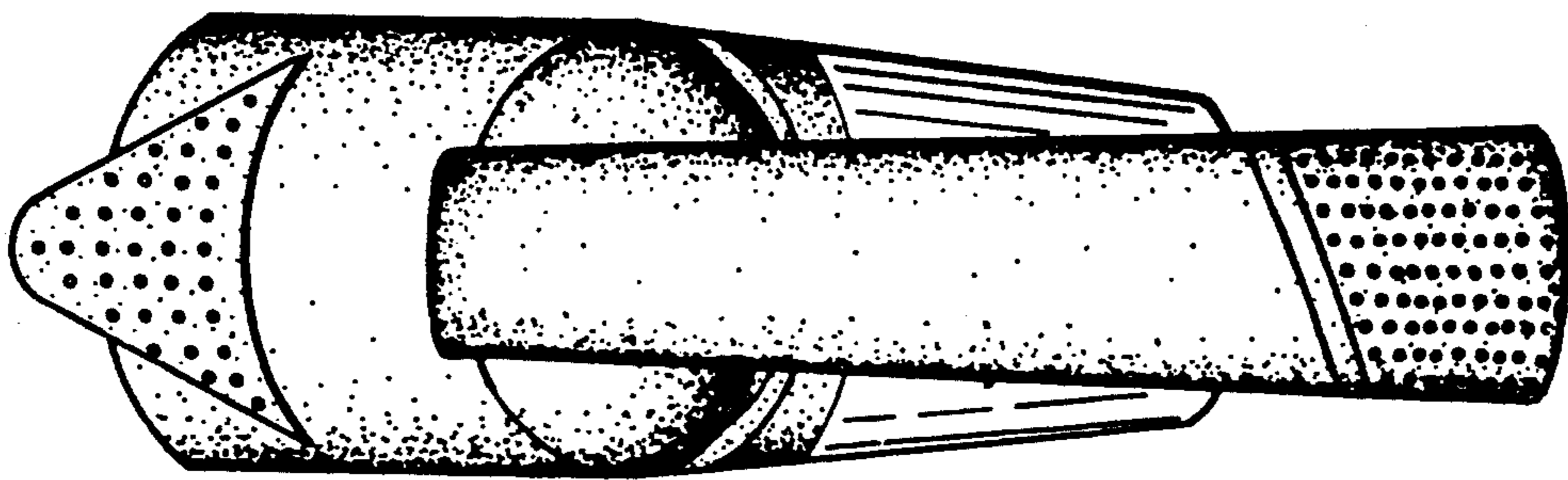

FIG.-27

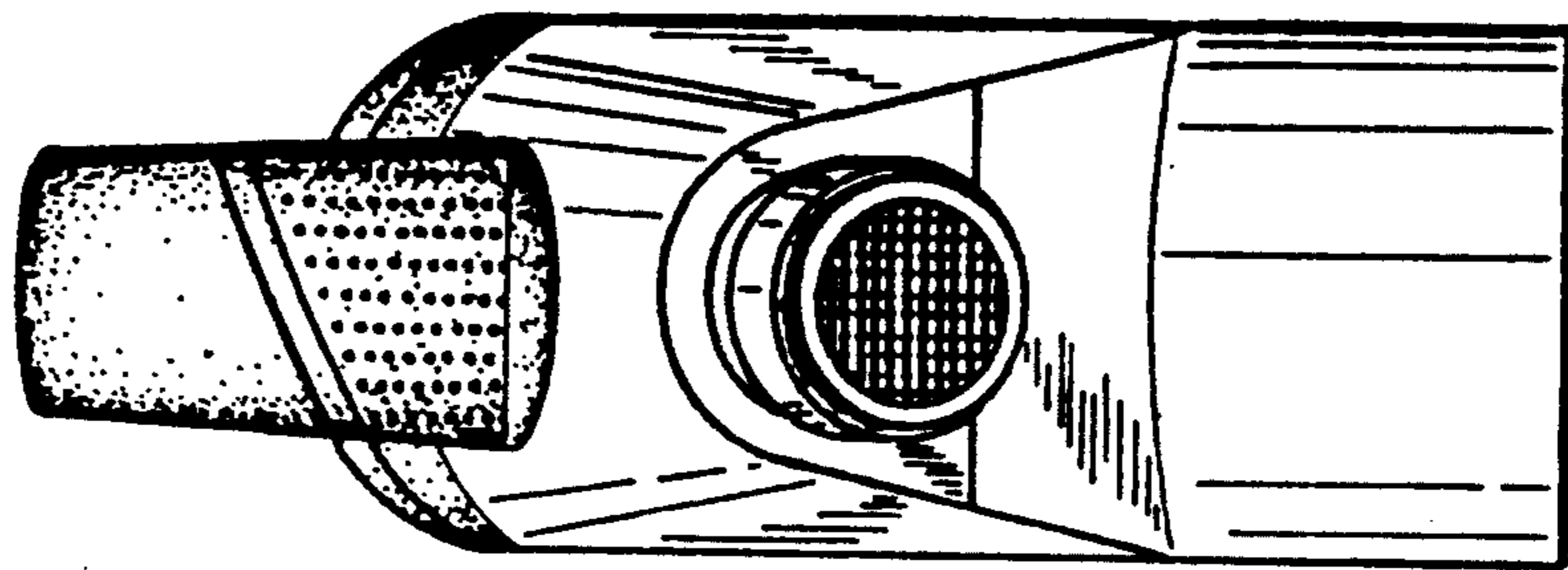

FIG.-24

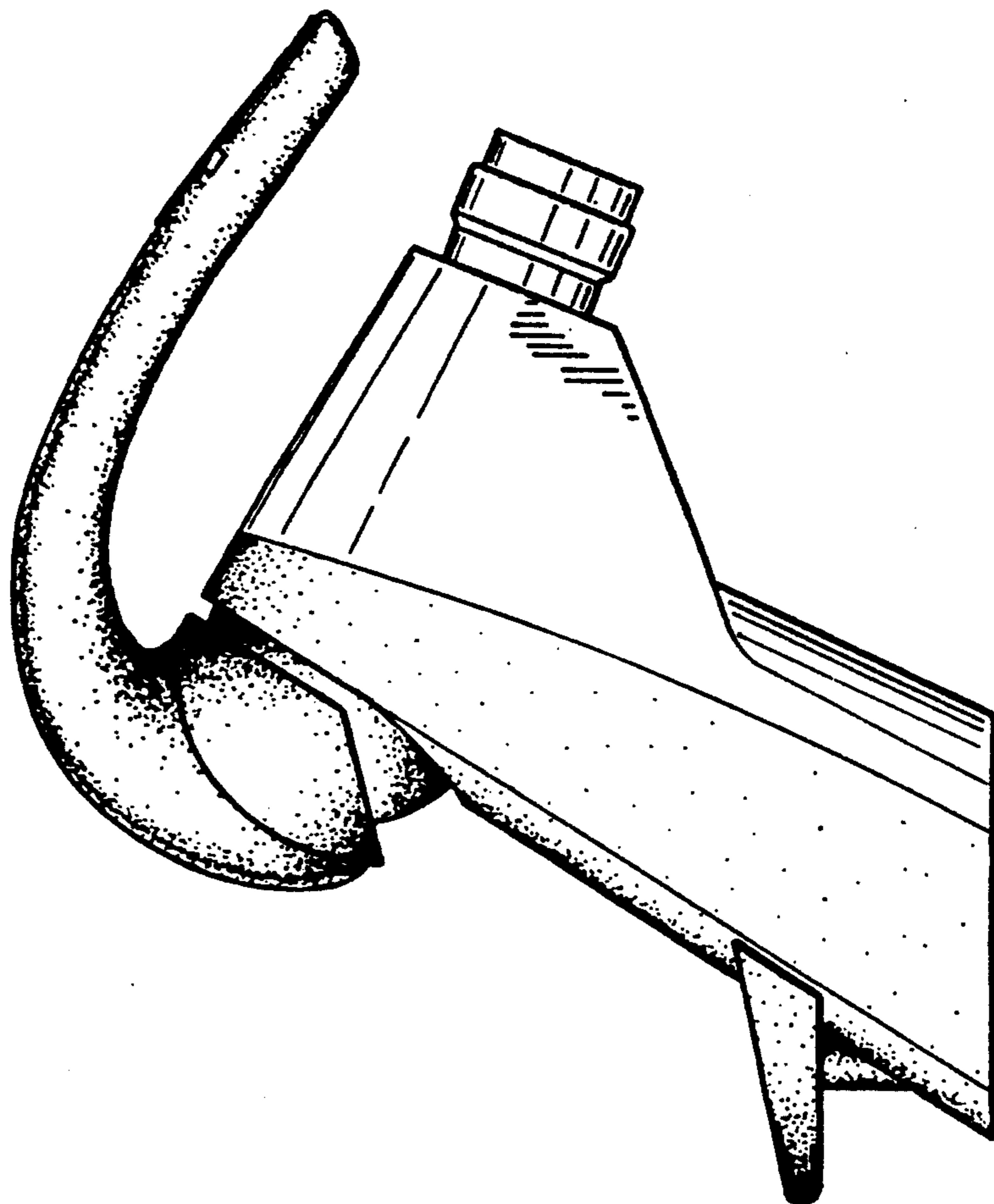

FIG.-23

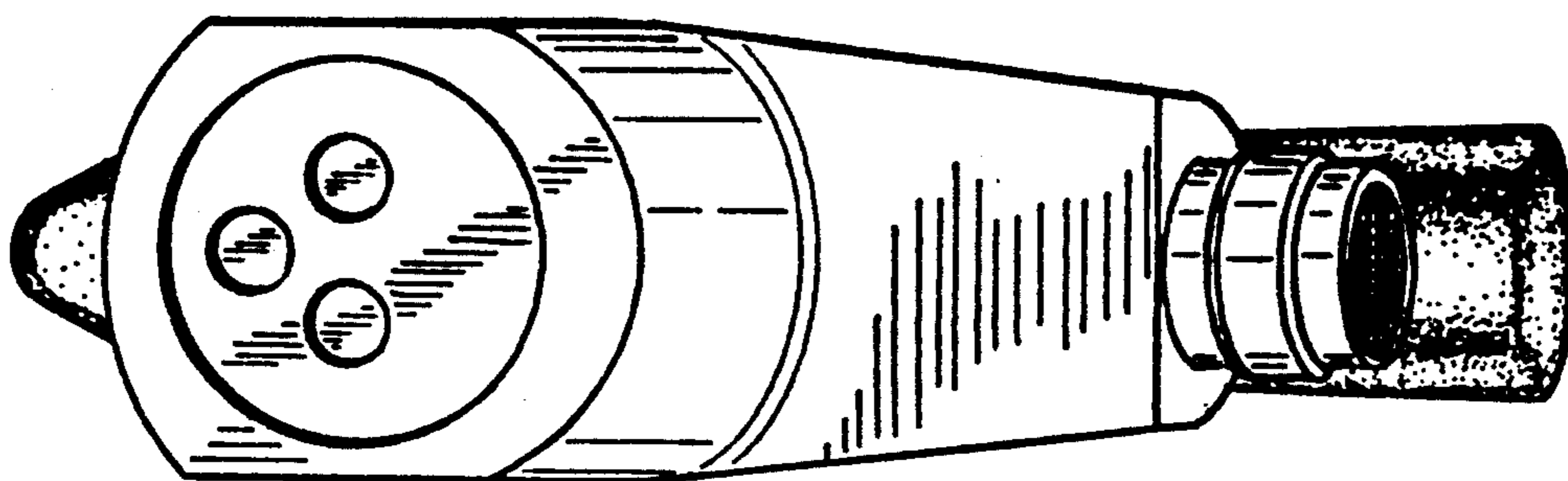

FIG.-28

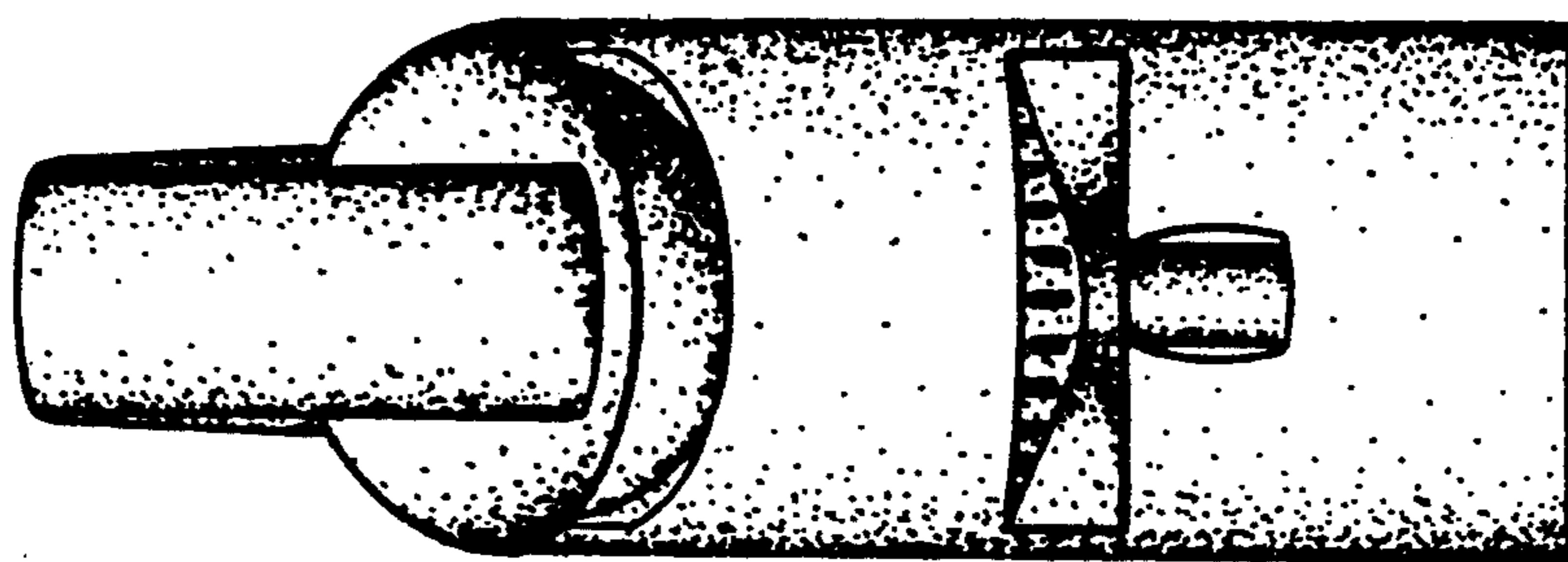

FIG.-26

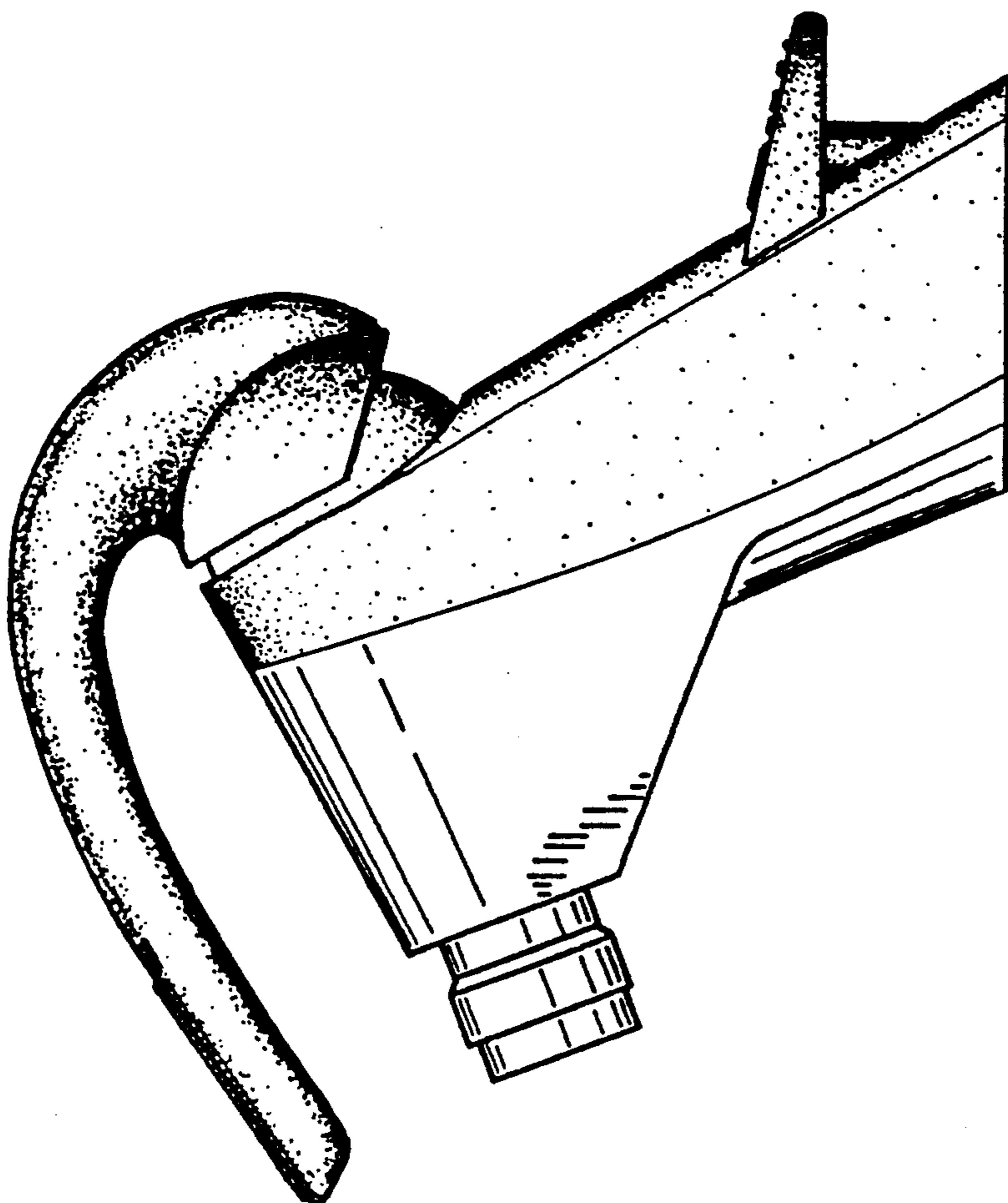

FIG.-25