



US00D339231S

United States Patent [19]

Perry

[11] Patent Number: Des. 339,231

[45] Date of Patent: ** Sep. 14, 1993

[54] CARRYING CASE FOR A PORTABLE TOILET

[76] Inventor: Ramona L. Perry, 1519 Mohican St., Philadelphia, Pa. 19138

[**] Term: 14 Years

[21] Appl. No.: 572,019

[22] Filed: Aug. 24, 1990

[52] U.S. Cl. D3/74

[58] Field of Search D23/270, 299; 4/476, 4/449, 599-603, 437, 439, 460, 483, 484; D3/30.1, 74, 78

2,431,538	11/1947	Brief et al.	4/476
2,923,950	2/1960	Carter	4/483 X
2,974,321	3/1961	Salka	4/476
3,343,179	9/1967	Sellars .	
3,364,478	1/1968	Waard .	
3,484,875	12/1969	Eisenberg	108/115
4,633,536	1/1987	Tribble-DuBose	4/460

Primary Examiner—James R. Largen
Attorney, Agent, or Firm—Terry M. Gernstein

[57] CLAIM

The ornamental design for a carrying case for a portable toilet, as shown and described.

DESCRIPTION

FIG. 1 is a perspective view of a carrying case for a portable toilet showing my new design;
 FIG. 2 is another perspective view thereof showing the cover in an open position;
 FIG. 3 is a front elevational view thereof;
 FIG. 4 is a rear elevational view thereof;
 FIG. 5 is a side elevational view thereof, the opposite side being a mirror image of the side shown;
 FIG. 6 is a top plan view thereof; and,
 FIG. 7 is a bottom view thereof.

The broken line representation of a portable toilet in FIG. 2 is for purposes of illustration only and forms no part of the claimed design.

[56] References Cited

U.S. PATENT DOCUMENTS

D. 143,491	1/1946	Hopkins	D3/74
D. 208,352	8/1967	Eisenberg	D23/299
D. 258,175	2/1981	Hazeltine	D3/74
D. 265,723	8/1982	Rosenthal	D3/74 X
D. 281,834	12/1985	Lin	D3/74
D. 323,881	2/1992	Frany	D23/299
1,026,413	5/1912	Sullivan	4/460
1,197,786	9/1916	Beach	4/483 X
1,428,627	9/1922	Grabfelder .	
1,527,370	2/1925	Wood	4/487
1,947,940	2/1934	Isom	4/483 X
2,073,390	3/1937	Giblette	4/483 X

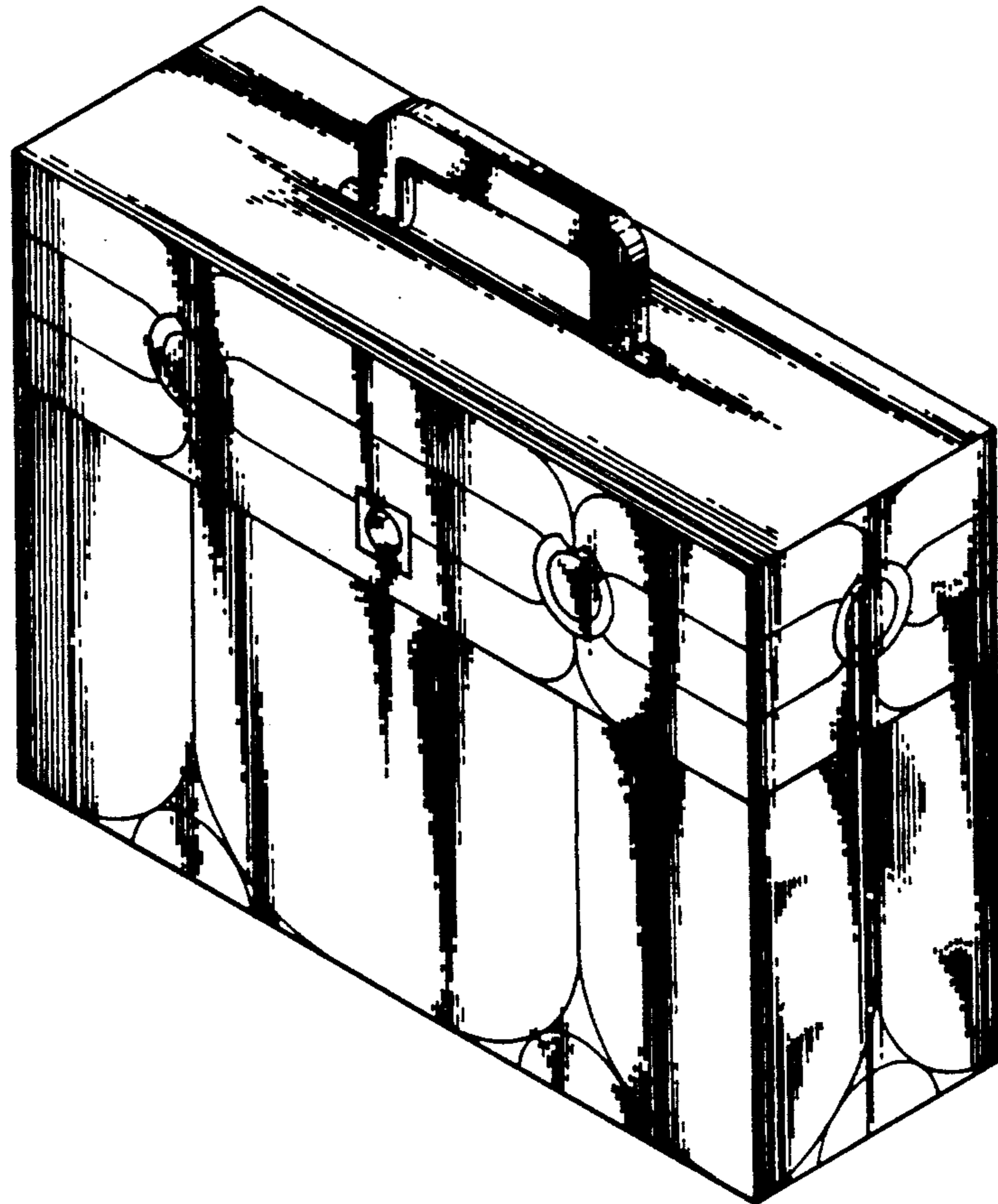

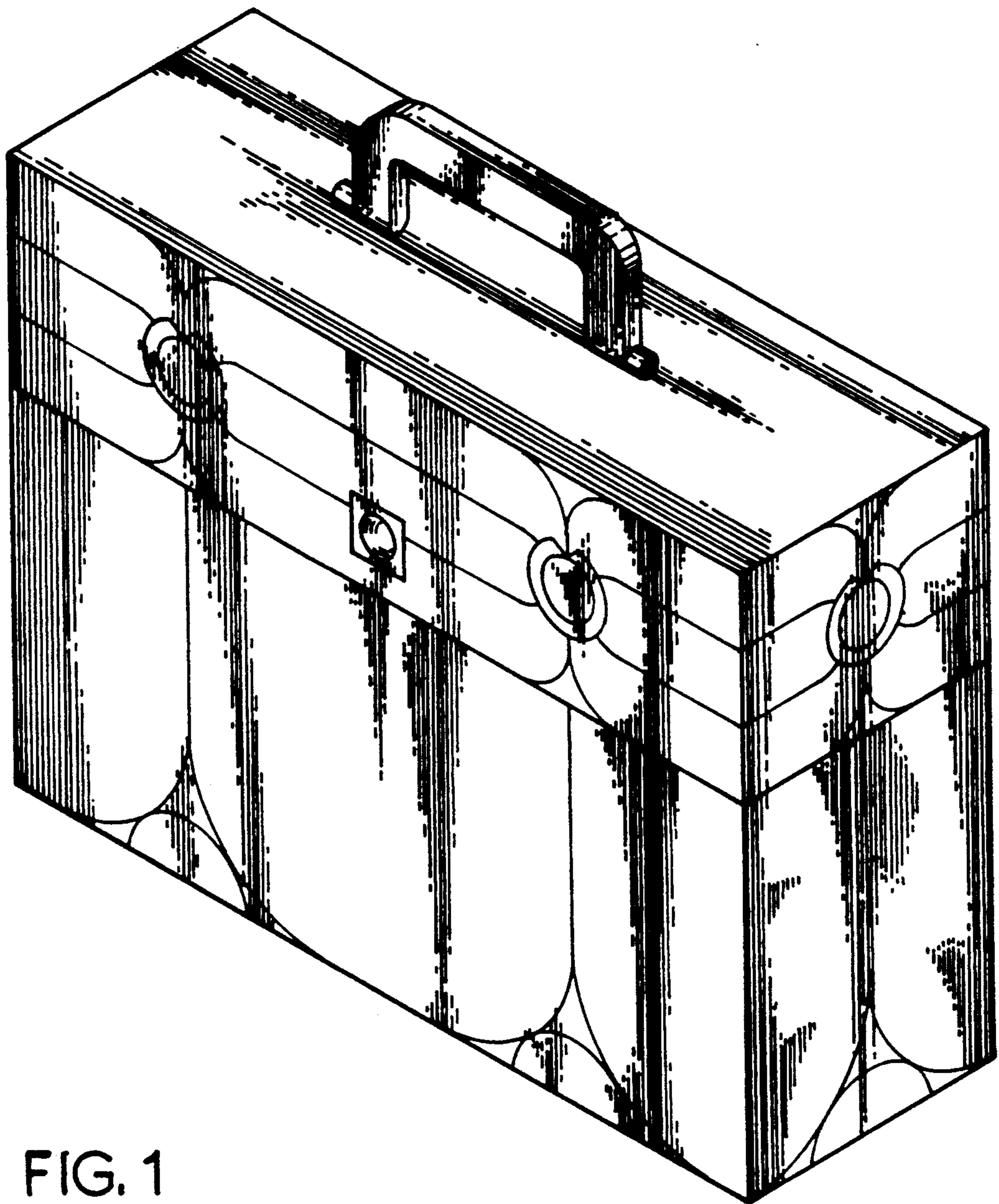

FIG. 1

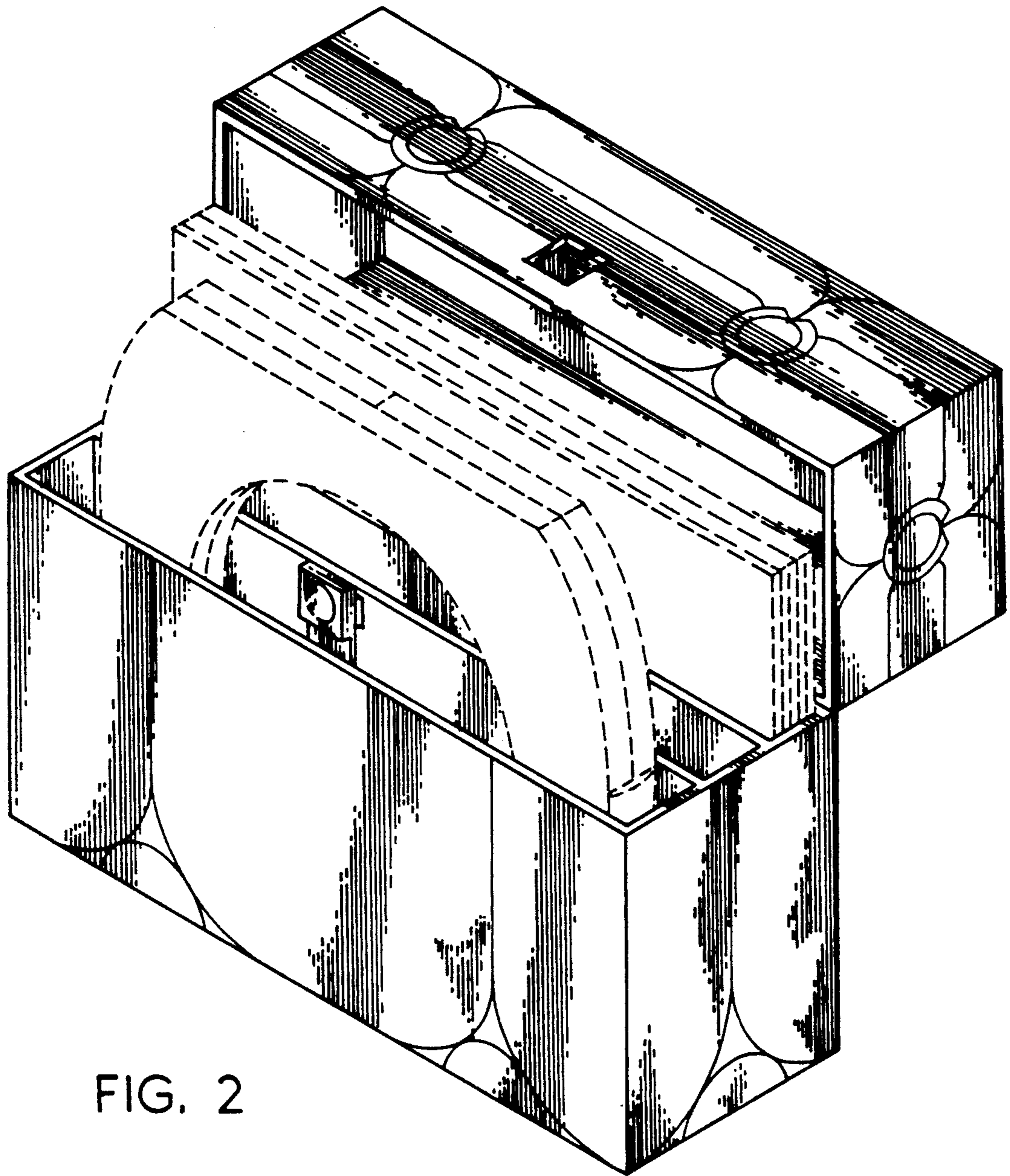

FIG. 2

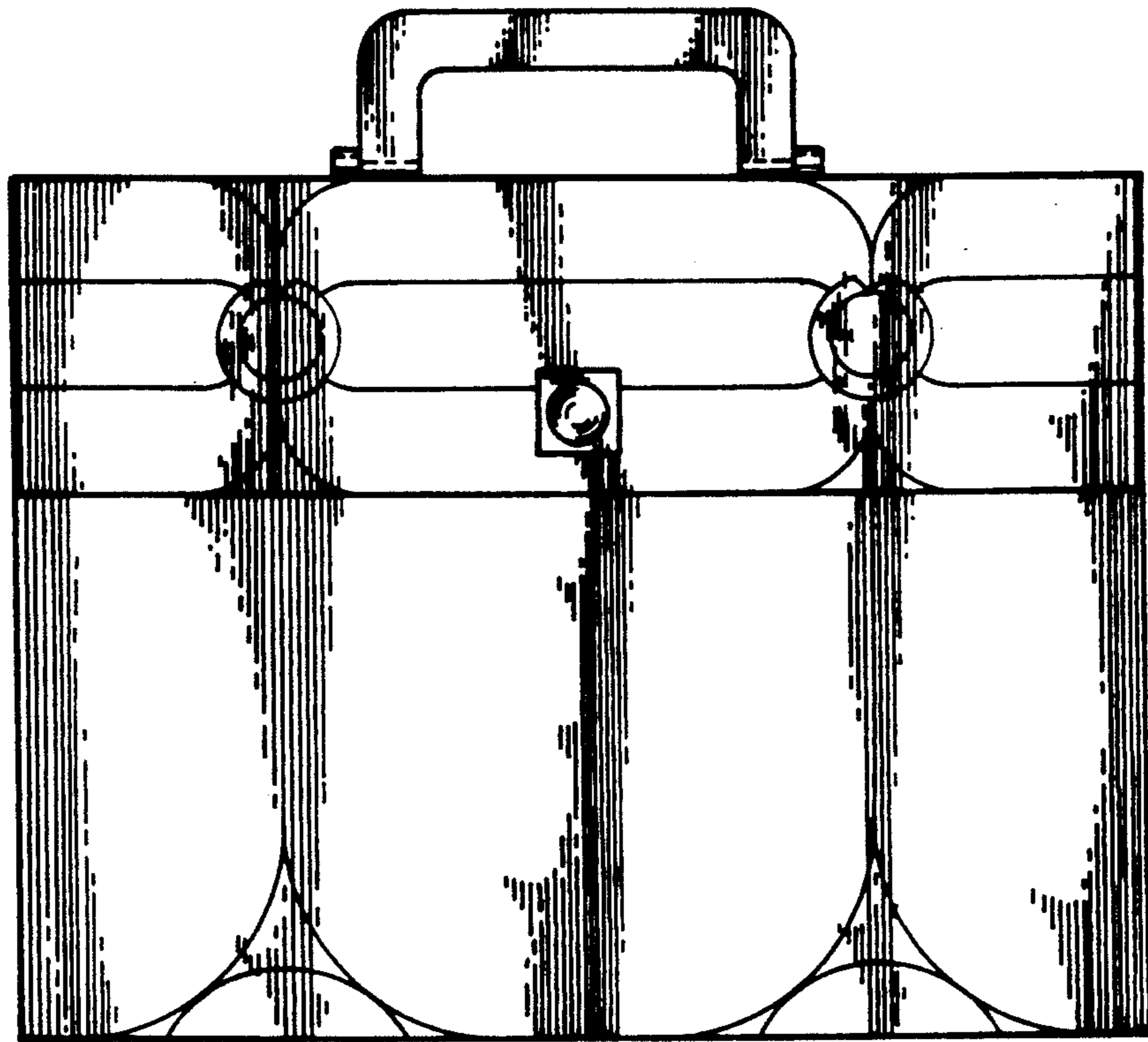

FIG. 3

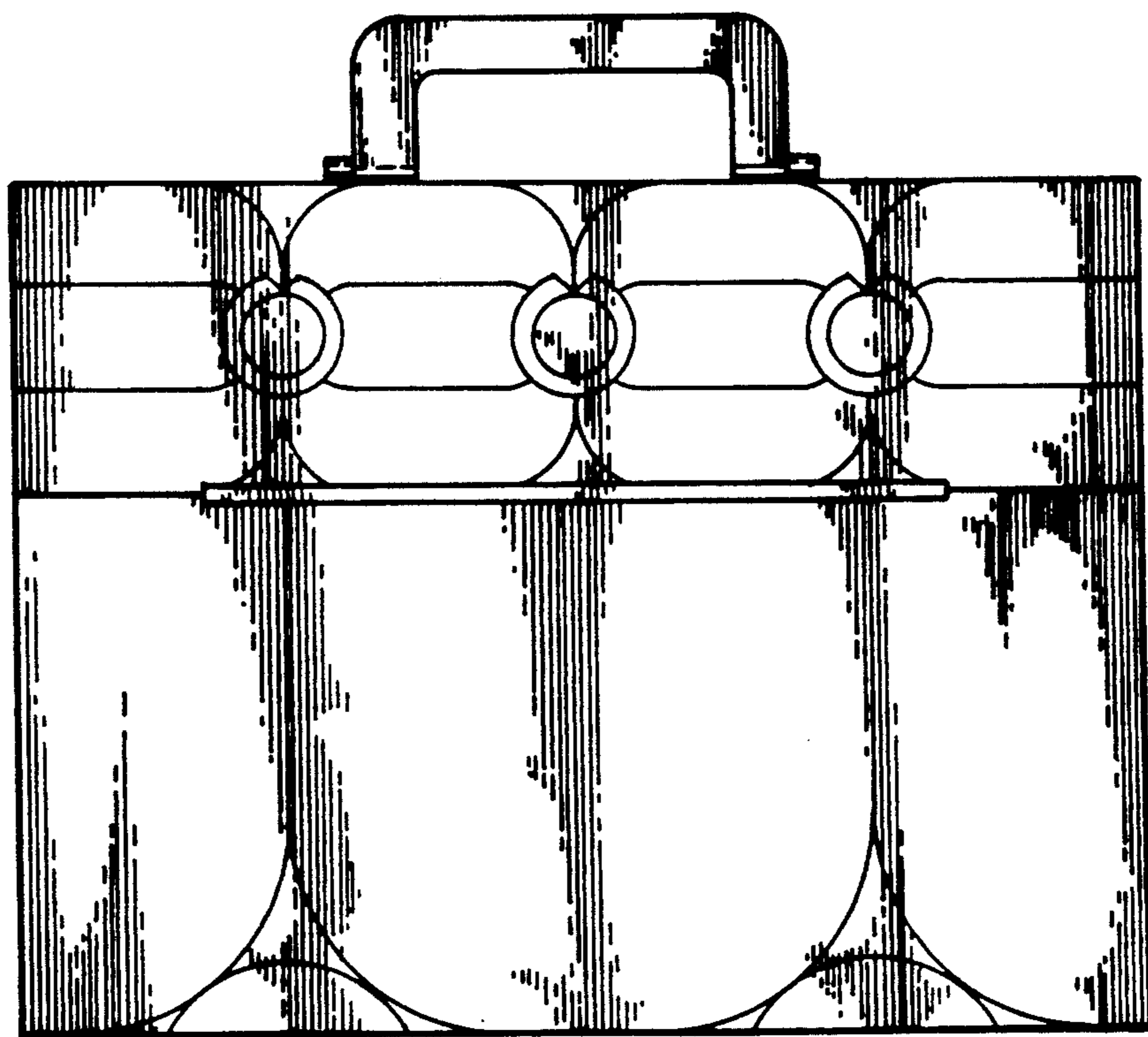

FIG. 4

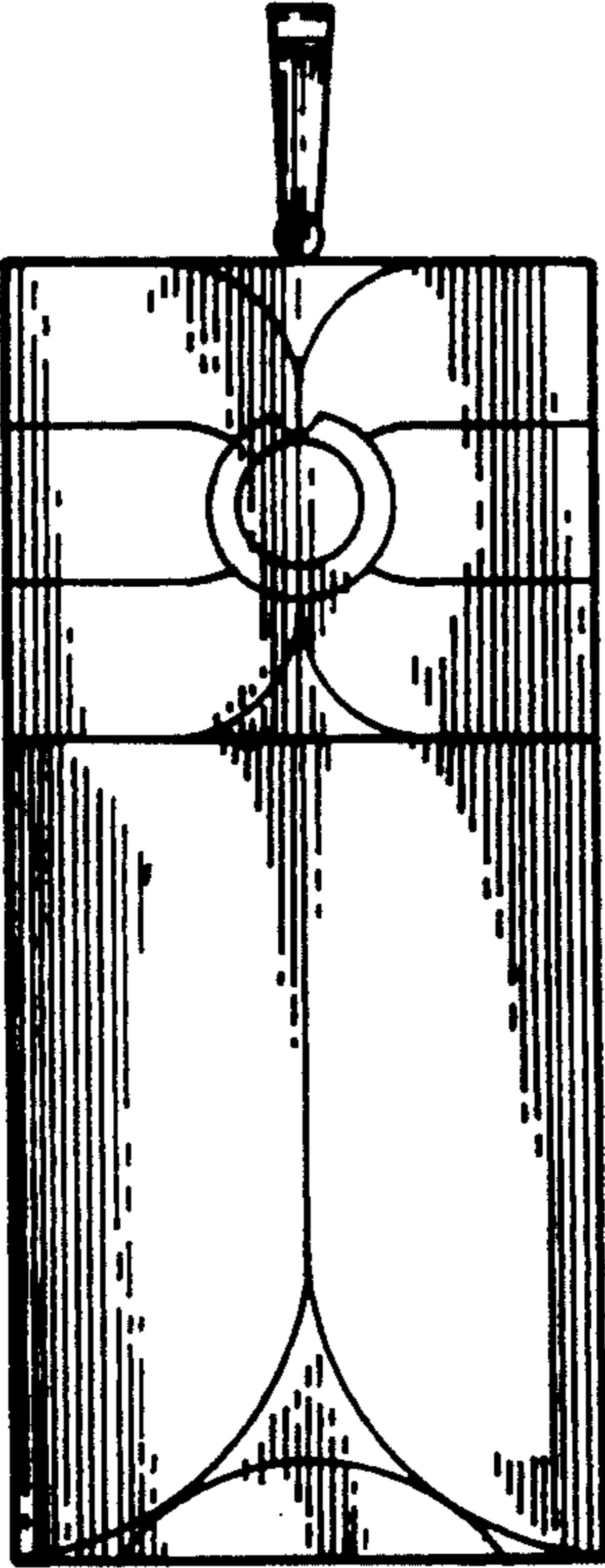

FIG. 5

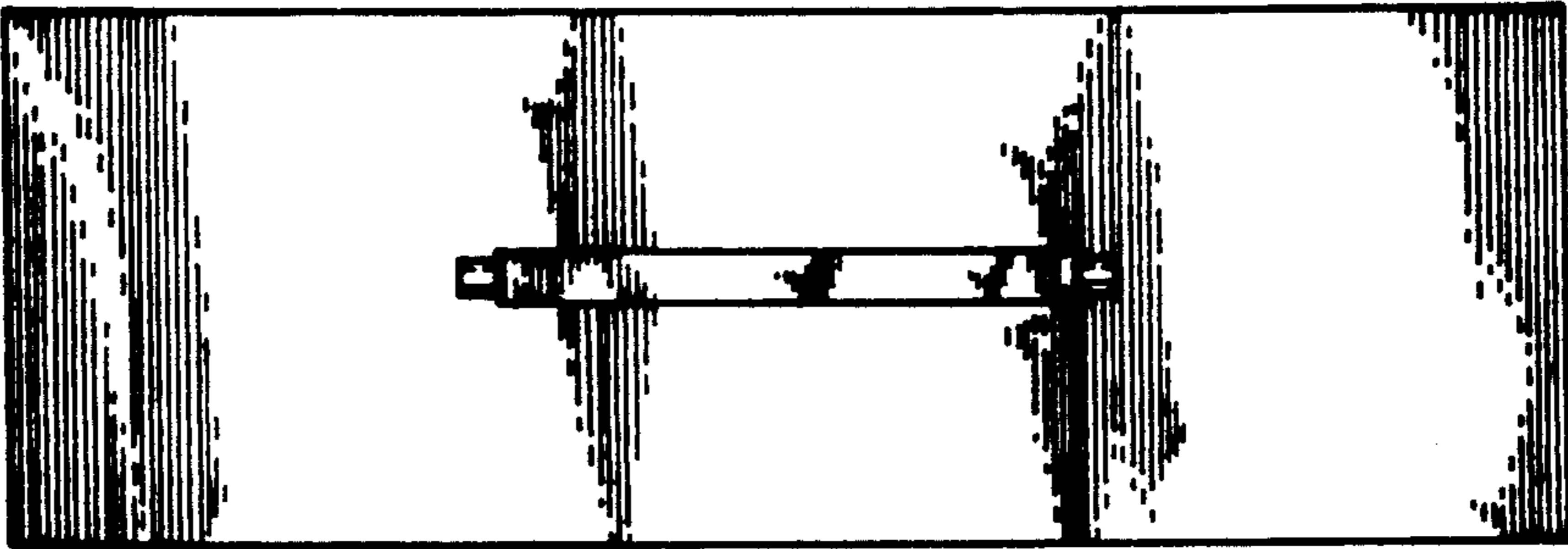

FIG. 6

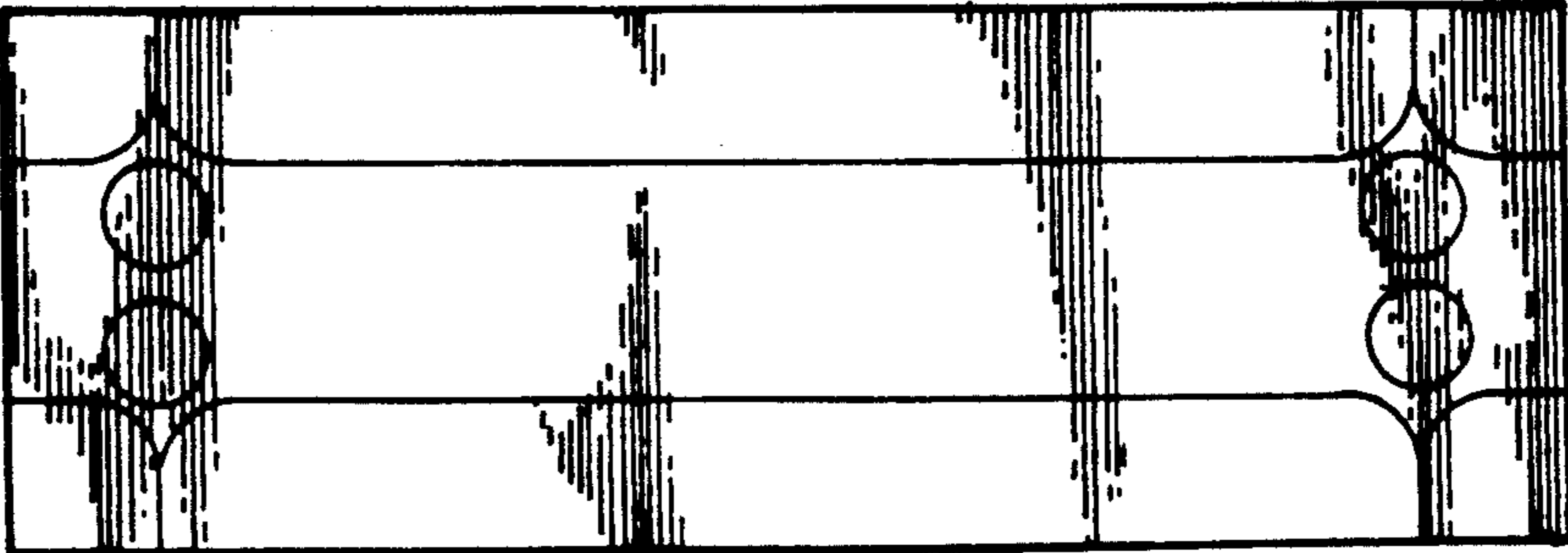

FIG. 7