



US00D339229S

United States Patent [19]

[11] Patent Number: **Des. 339,229**

Lopez

[45] Date of Patent: **** Sep. 14, 1993**

[54] **PURSE LIGHT**

4,954,934 9/1990 Kidder et al. 362/156
5,018,057 5/1991 Biggs et al. 362/156 X

[76] Inventor: **Edward Lopez**, 309 North 6th St.,
Donna, Tex. 78537

FOREIGN PATENT DOCUMENTS

[**] Term: **14 Years**

819915 9/1959 United Kingdom 362/156

[21] Appl. No.: **754,432**

Primary Examiner—Louis S. Zarfaz
Attorney, Agent, or Firm—Leon Gilden

[22] Filed: **Sep. 3, 1991**

[57] CLAIM

The ornamental design for a purse light, as shown and described.

Related U.S. Application Data

DESCRIPTION

[63] Continuation-in-part of Ser. No. 151,523, Feb. 19, 1988,
abandoned.

FIG. 1 is a front elevational view of the purse light showing my new design;

[52] U.S. Cl. **D3/54**

FIG. 2 is a rear elevational view thereof;

[58] Field of Search **D3/41-54;**

FIG. 3 is a left side elevational view thereof;

362/156; 150/100, 103-108, 110-113, 117-119;
190/100, 107, 115

FIG. 4 is a right side elevational view thereof;

FIG. 5 is a top plan view thereof;

[56] References Cited

U.S. PATENT DOCUMENTS

D. 315,830 4/1991 Roberts D3/52
1,183,268 5/1916 Baldwin et al. D3/43 X
2,218,396 10/1940 Hallbauer D3/43 X
4,912,611 3/1990 Lyle 362/156

FIG. 6 is a bottom plan view thereof; and,

FIG. 7 is an isometric view of the invention showing a use thereof.

The broken line showing of a purse in FIG. 7 is for illustrative purposes only and forms no part of the claimed design.

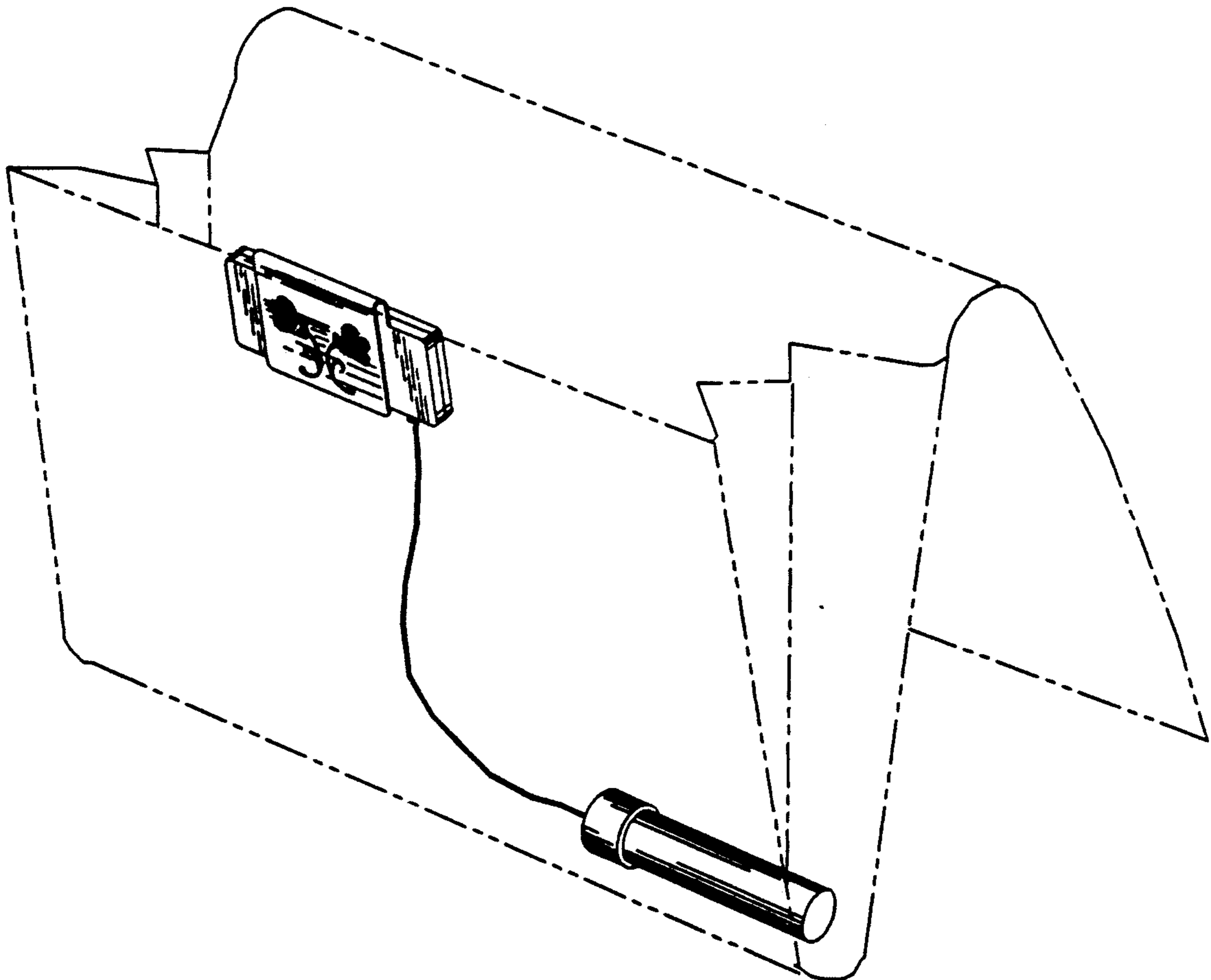

FIG. 1

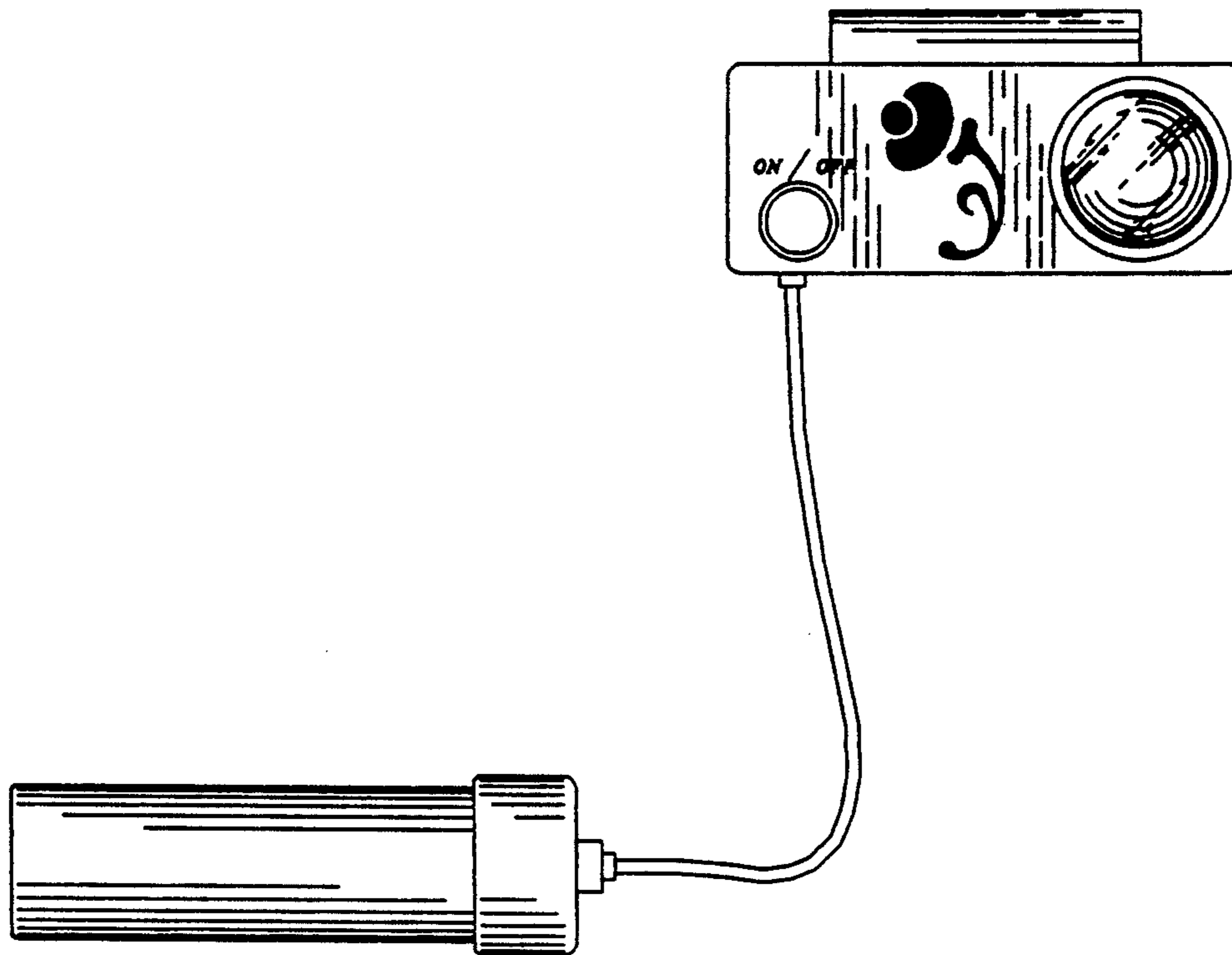

FIG. 2

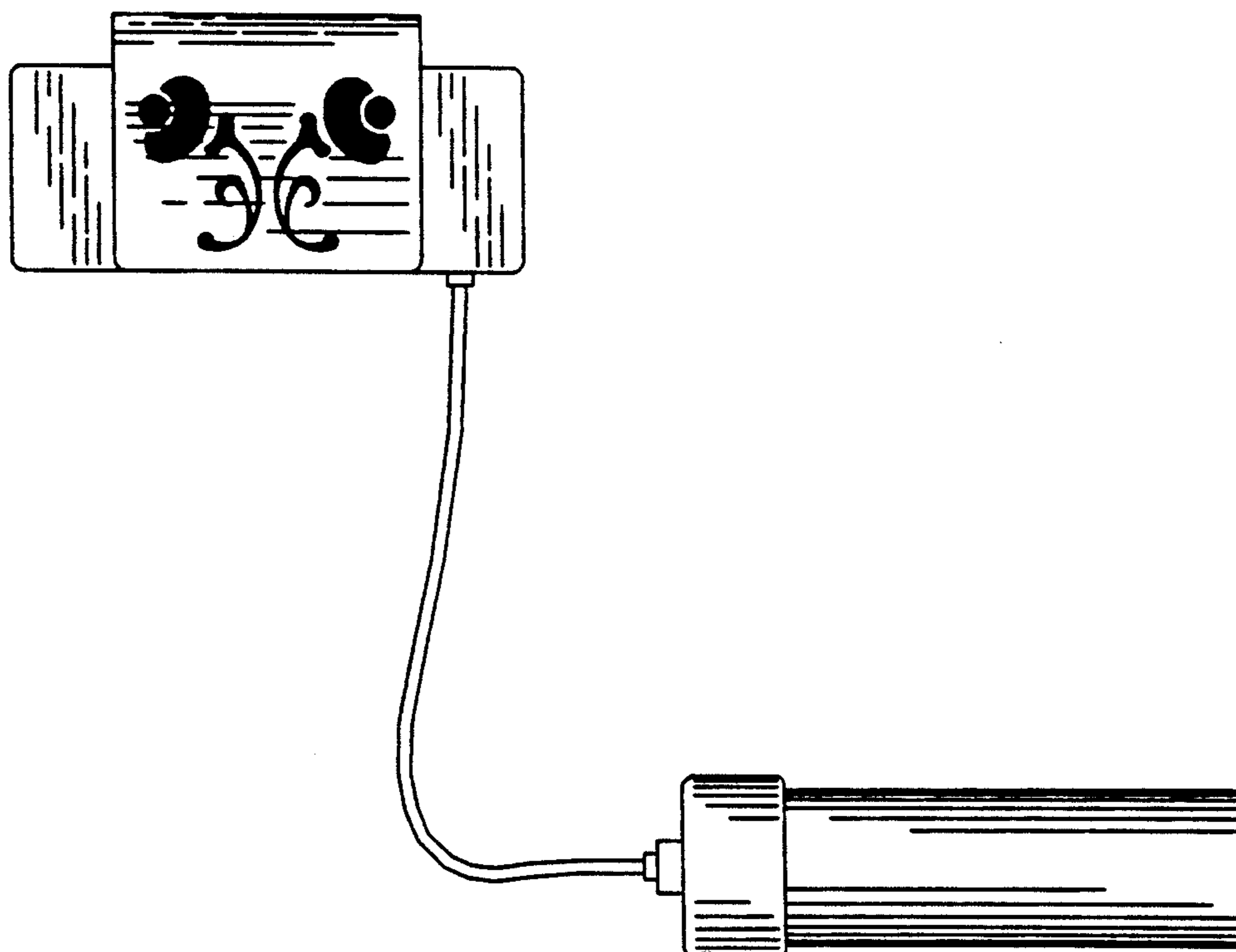

FIG. 3

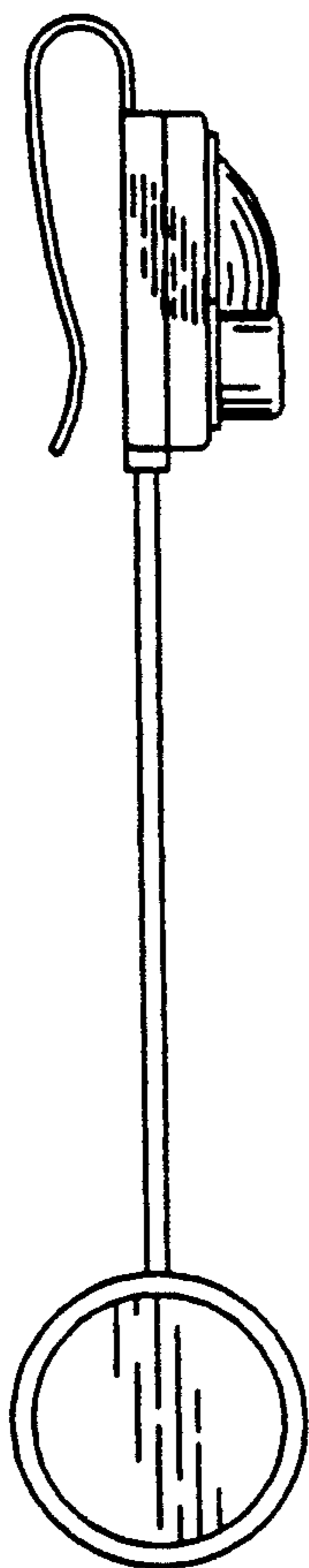

FIG. 4

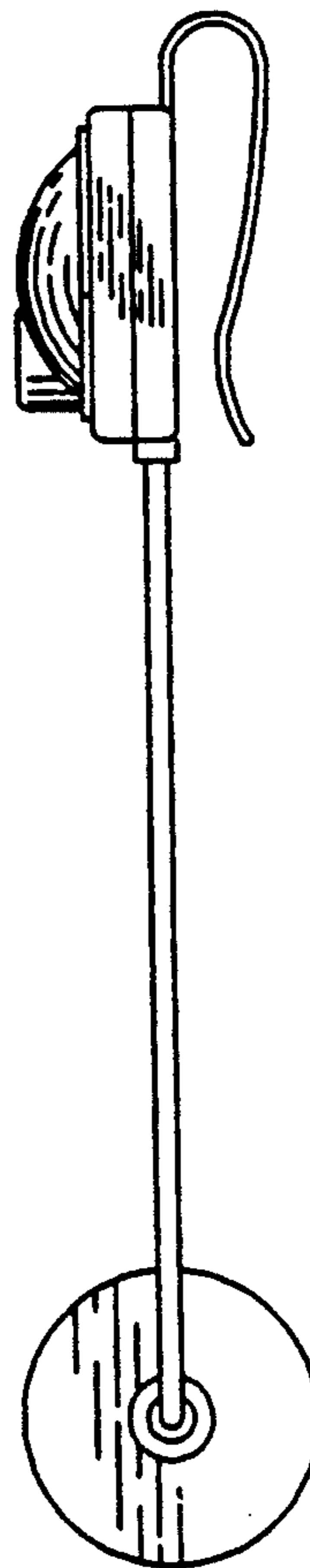

FIG. 5

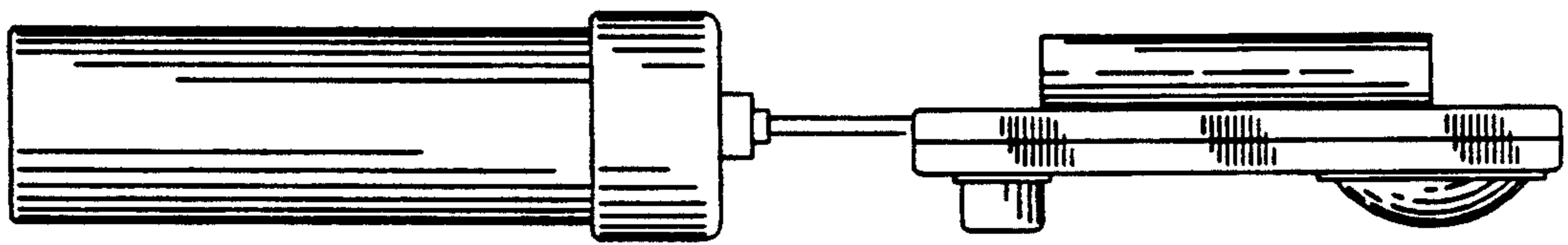

FIG. 6

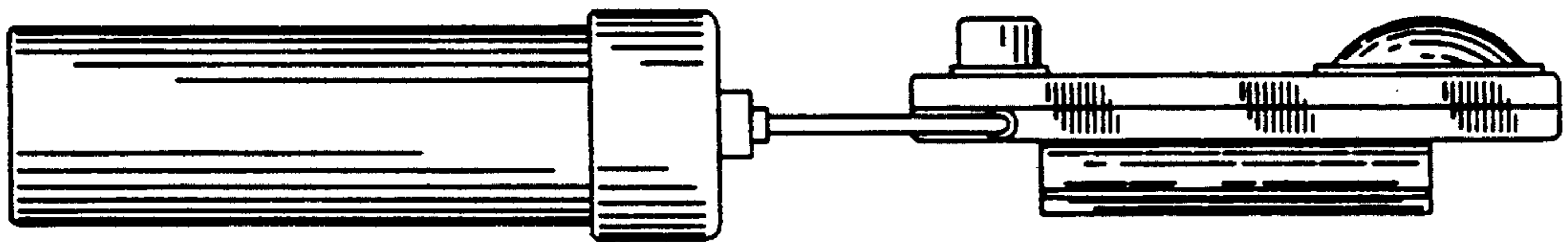

FIG. 7

