



US00D339135S

# United States Patent [19]

[11] Patent Number: **Des. 339,135**

Ito et al.

[45] Date of Patent: **\*\* Sep. 7, 1993**

[54] **DIGITAL AUDIO DISC PLAYER**

[56] **References Cited**

[75] Inventors: **Masafumi Ito, Tokyo; Minoru Sube, Hachioji; Hiroyuki Watanabe, Hanno; Yukio Iikura, Asaka, all of Japan**

**U.S. PATENT DOCUMENTS**

D. 327,889 7/1992 Ito et al. .... D14/156

[73] Assignee: **Teac Corporation, Japan**

**OTHER PUBLICATIONS**

Stereo Magazine, Apr., 1990, compact disc player.

[\*\*] Term: **14 Years**

*Primary Examiner*—Terry A. Wallace  
*Attorney, Agent, or Firm*—Andrus, Sceales, Starke & Sawall

[21] Appl. No.: **683,658**

[57] **CLAIM**

The ornamental design for a digital audio disc player, as shown and described.

[22] Filed: **Apr. 11, 1991**

**DESCRIPTION**

[30] **Foreign Application Priority Data**

Oct. 26, 1990 [JP] Japan ..... 2-36070

[52] U.S. Cl. .... **D14/156**

[58] Field of Search ..... D14/135-136,  
D14/156, 160-162, 164-165, 168-169, 299;  
369/75.1, 77.1, 77.2

FIG. 1 is a top plan view of the digital audio disc player showing our new design;  
FIG. 2 is a bottom plan view thereof;  
FIG. 3 is a front elevational view thereof;  
FIG. 4 is a rear elevational view thereof;  
FIG. 5 is a left side elevational view thereof;  
FIG. 6 is a right side elevational view thereof; and,  
FIG. 7 is a perspective view thereof shown in an open position.

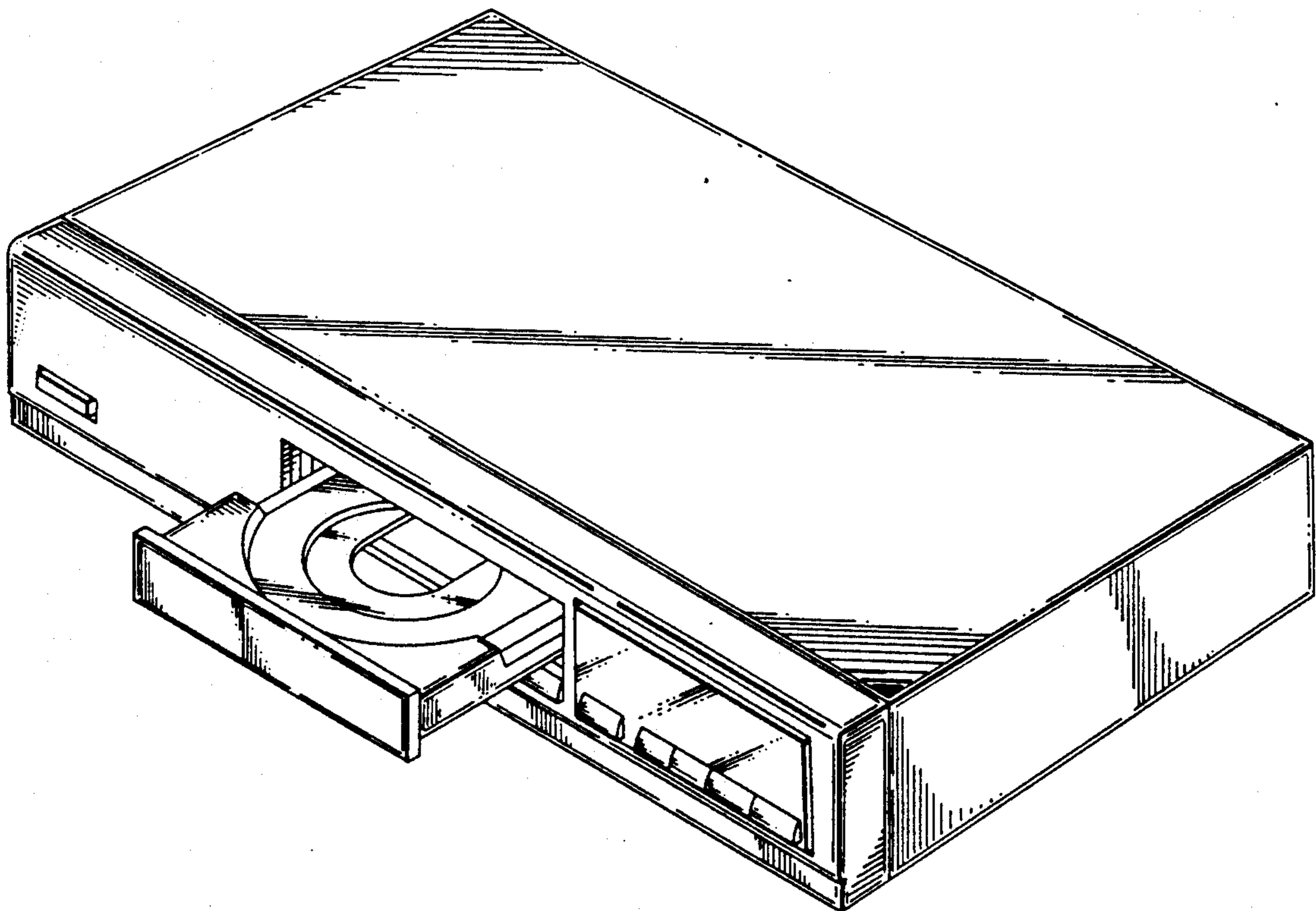

*FIG. 1*

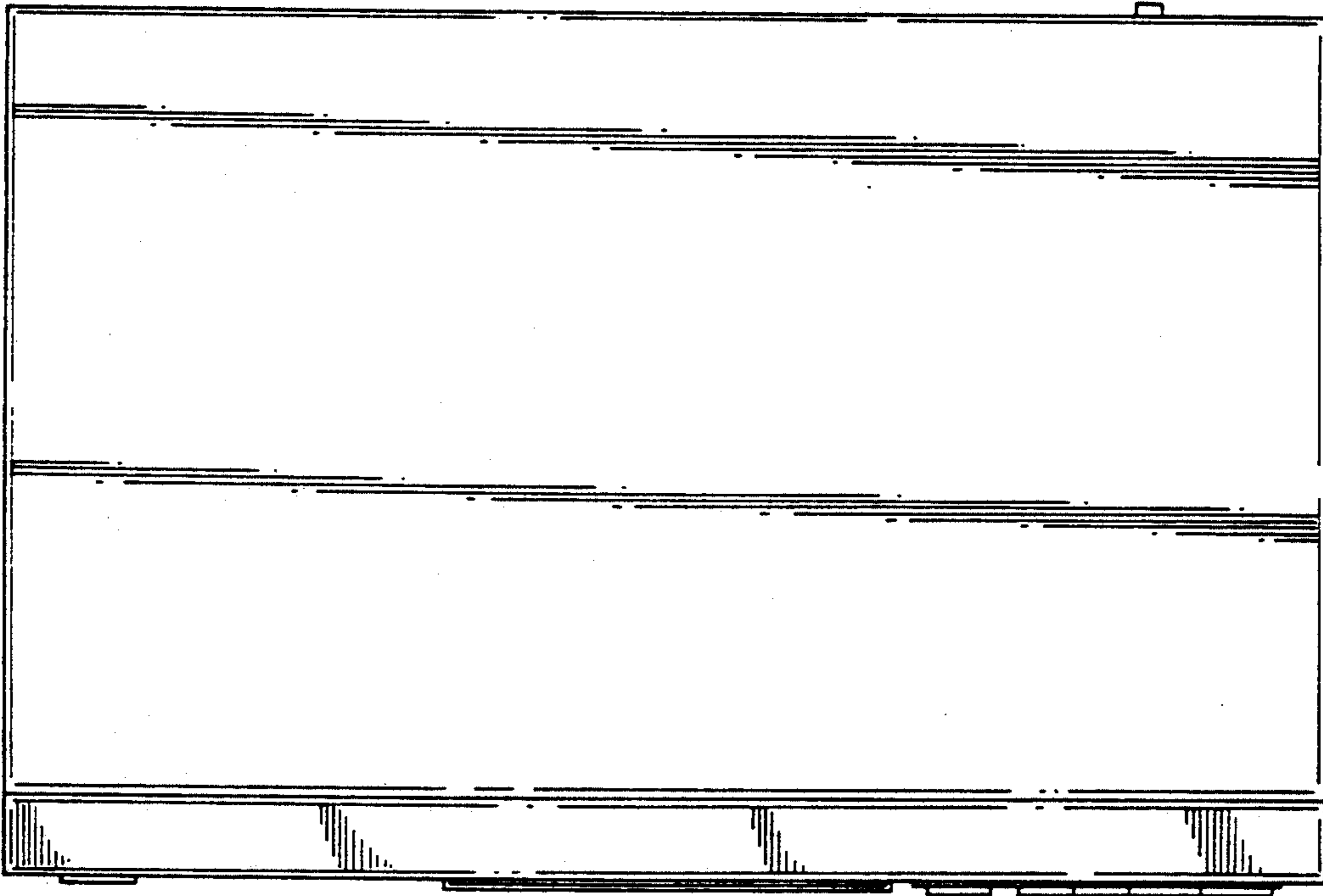

**FIG. 2**

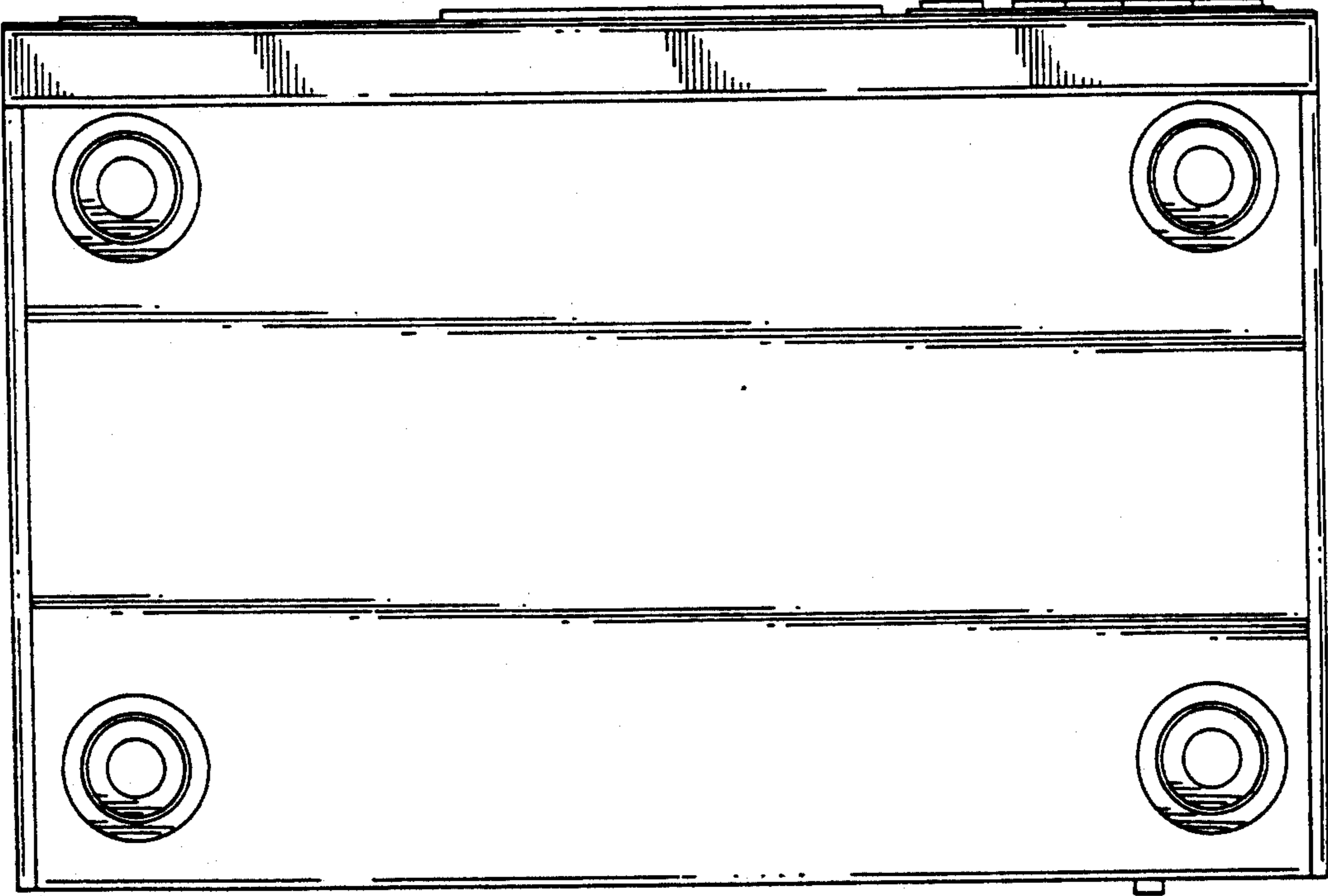

**FIG. 3**

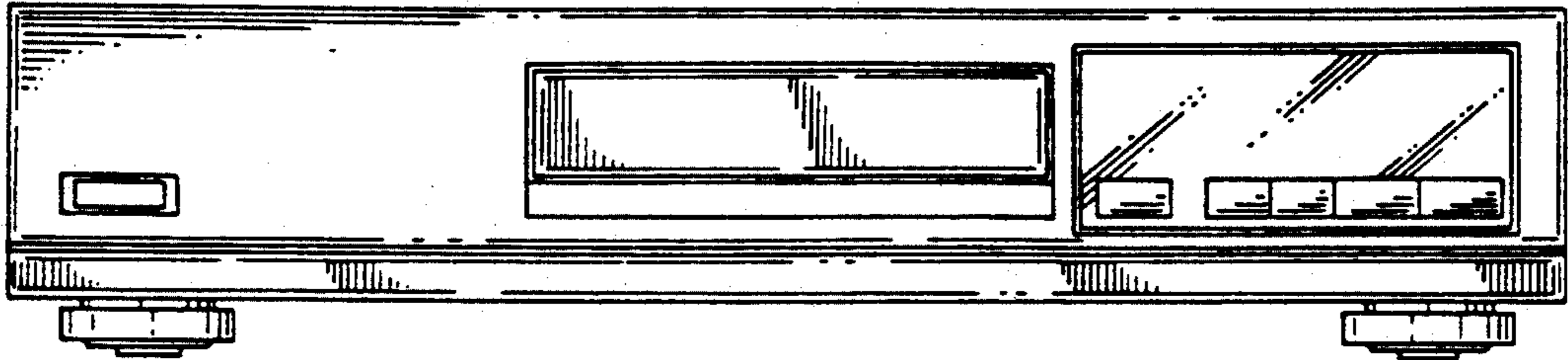

**FIG. 4**

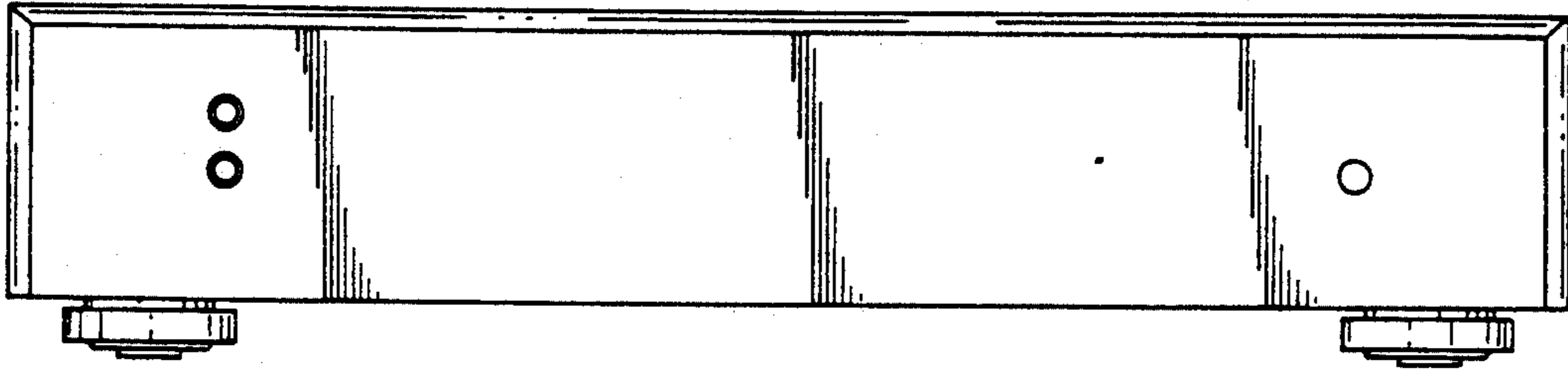

**FIG. 5**

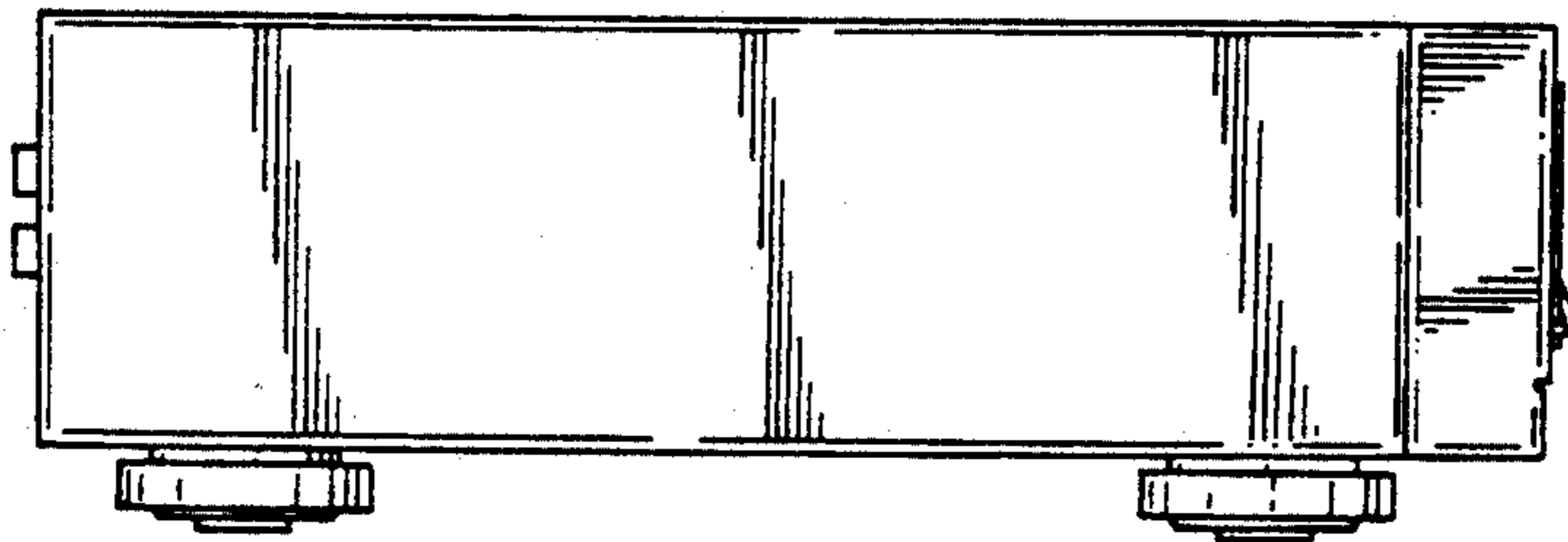

**FIG. 6**

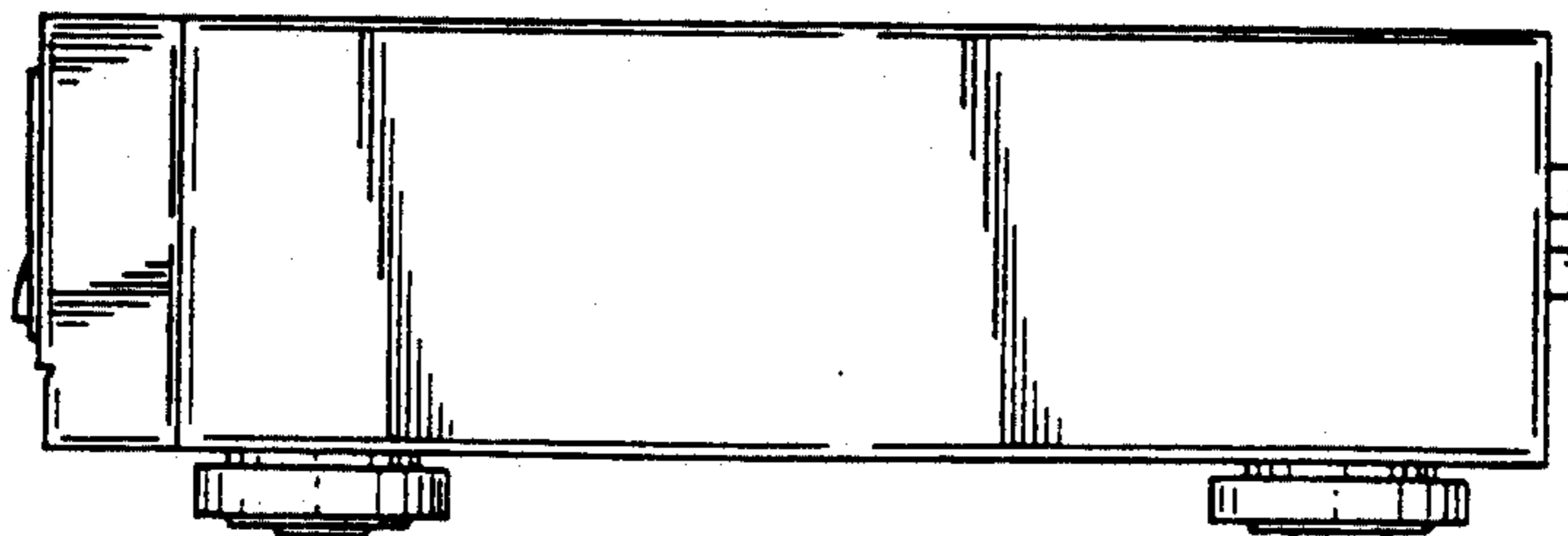



FIG. 7

