



US00D339112S

United States Patent [19]

[11] Patent Number: Des. 339,112

Foy et al.

[45] Date of Patent: ** Sep. 7, 1993

[54] PORTABLE COMPUTER HOUSING

[75] Inventors: Hunter T. Foy, Boca Raton; Frederick E. Goetz, Niceville; Joseph E. Jasinski, Delray Beach; David F. Loricchio; Michael S. Miller, both of Boca Raton; Richard F. Pollitt, Jensen Beach, all of Fla.; Homer Shelton, Jr., Lexington, Ky.

[73] Assignee: International Business Machines Corporation, Armonk, N.Y.

[**] Term: 14 Years

[21] Appl. No.: 645,663

[22] Filed: Jan. 25, 1991

[52] U.S. Cl. D14/106

[58] Field of Search D14/100, 101, 106, 113, D14/115; D18/1, 7, 11, 12; 235/145 A, 145 R; 340/700, 706; 341/22, 23; 361/390, 394; 364/708, 709.04

[56] References Cited

U.S. PATENT DOCUMENTS

- D. 290,845 7/1987 Yubisui et al. D14/100 X
- D. 308,861 6/1990 Tsukada et al. D14/106
- D. 310,828 9/1990 Grundstrom et al. D14/106
- D. 312,822 12/1990 Watabe et al. D14/106
- D. 317,442 6/1991 Gintz et al. D14/106

Primary Examiner—Wallace R. Burke
Assistant Examiner—Freda S. Nunn
Attorney, Agent, or Firm—Martin J. McKinley

[57] CLAIM

The ornamental design for a portable computer housing, as shown and described.

DESCRIPTION

FIG. 1 is a right front and top perspective view of the portable computer housing with the cover in the opened position;

FIG. 2 is a rear left side and bottom perspective view thereof;

FIG. 3 is a front elevational view thereof;

FIG. 4 is a top plan view thereof;

FIG. 5 is a right side elevational view thereof;

FIG. 6 is a left side elevational view thereof;

FIG. 7 is a rear elevational view thereof;

FIG. 8 is a bottom plan view thereof;

FIG. 9 is a right front and top perspective view thereof with the cover in the closed position;

FIG. 10 is a rear left side and bottom perspective view thereof;

FIG. 11 is a front elevational view thereof;

FIG. 12 is a rear elevational view thereof;

FIG. 13 is a right side elevational view thereof;

FIG. 14 is a left side elevational view thereof;

FIG. 15 is a top plan view thereof; and,

FIG. 16 is a bottom plan view thereof.

FIGS. 1 and 2 are drawn on a reduced scale.

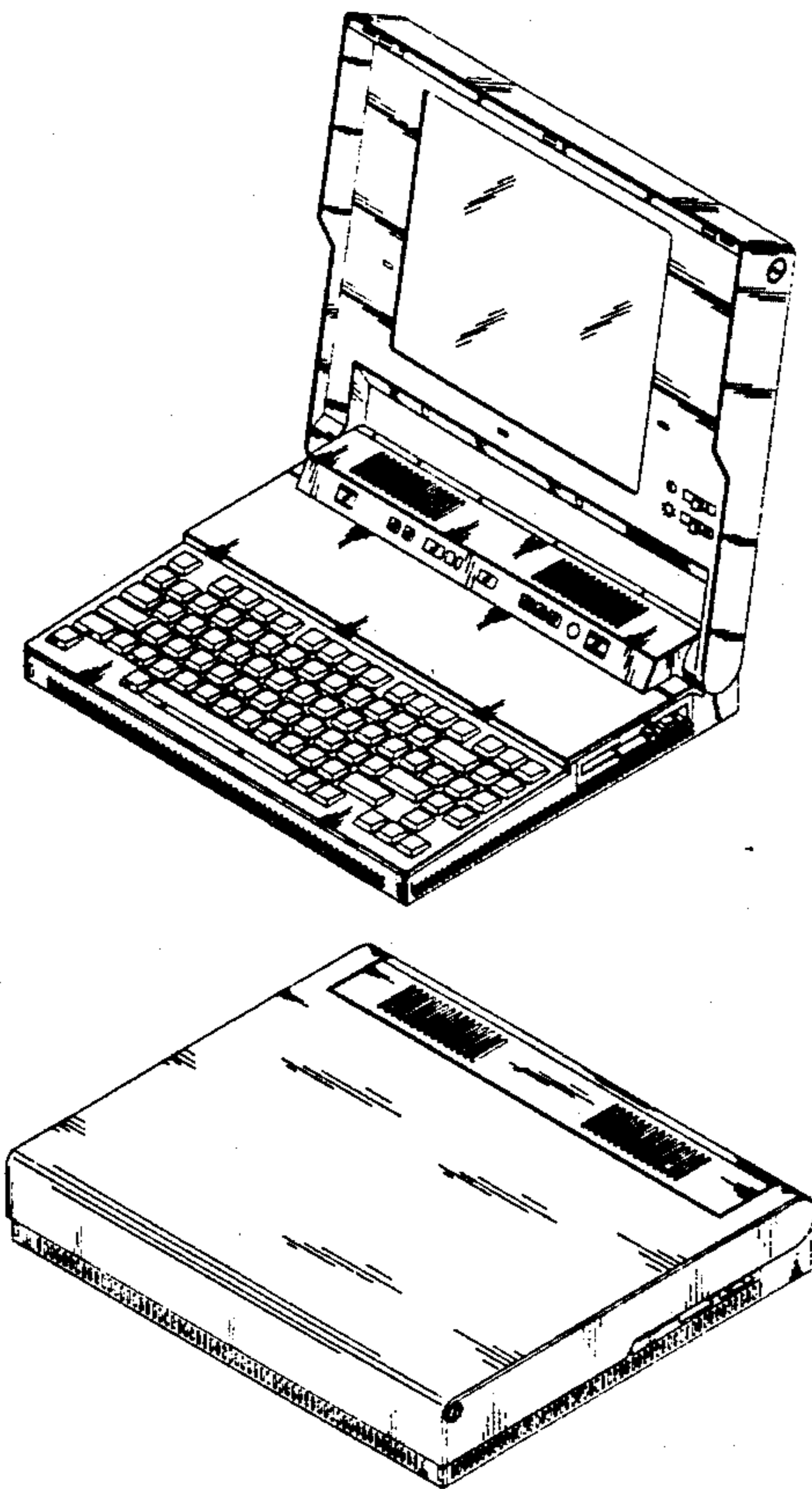

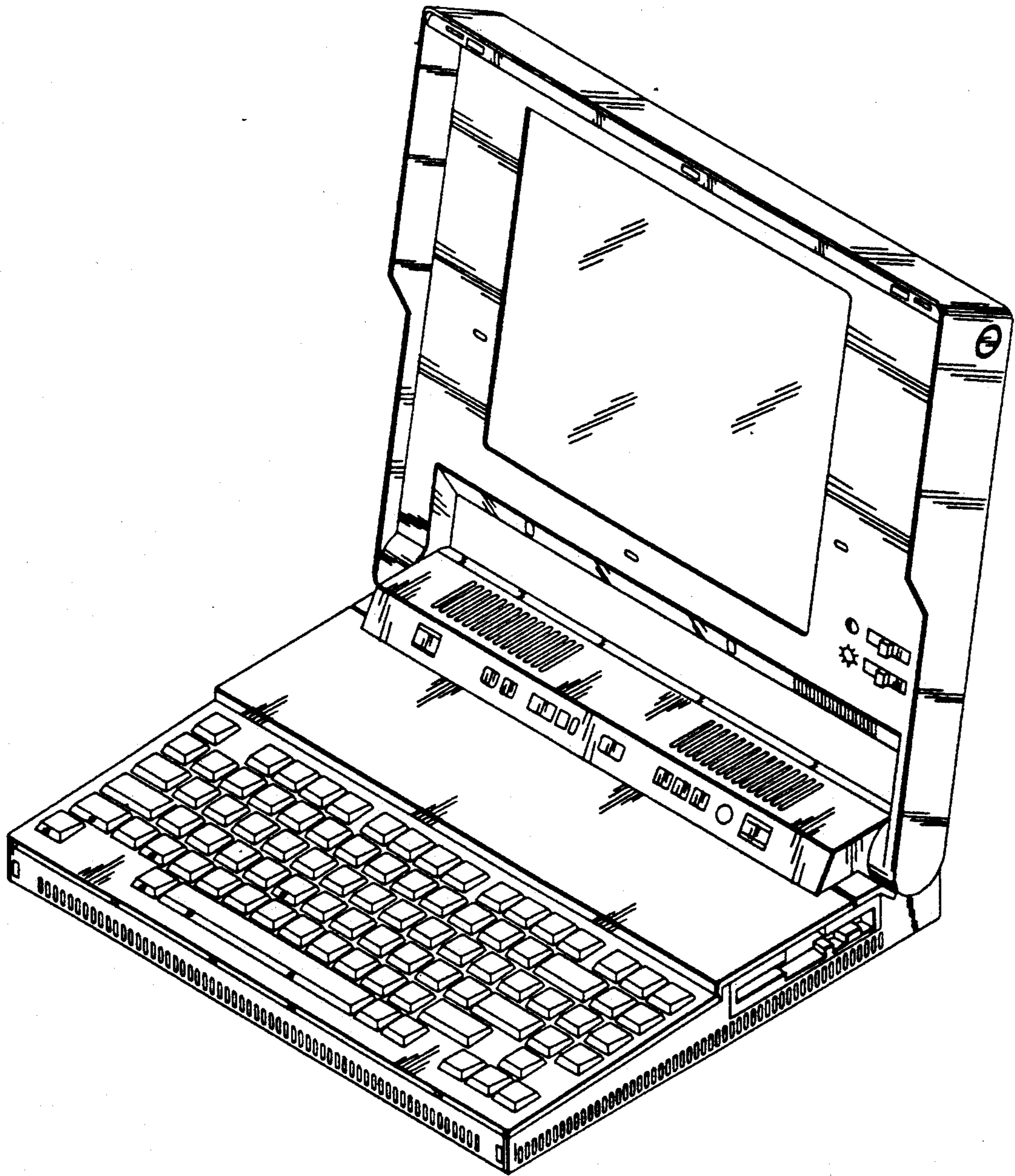

FIG. 1

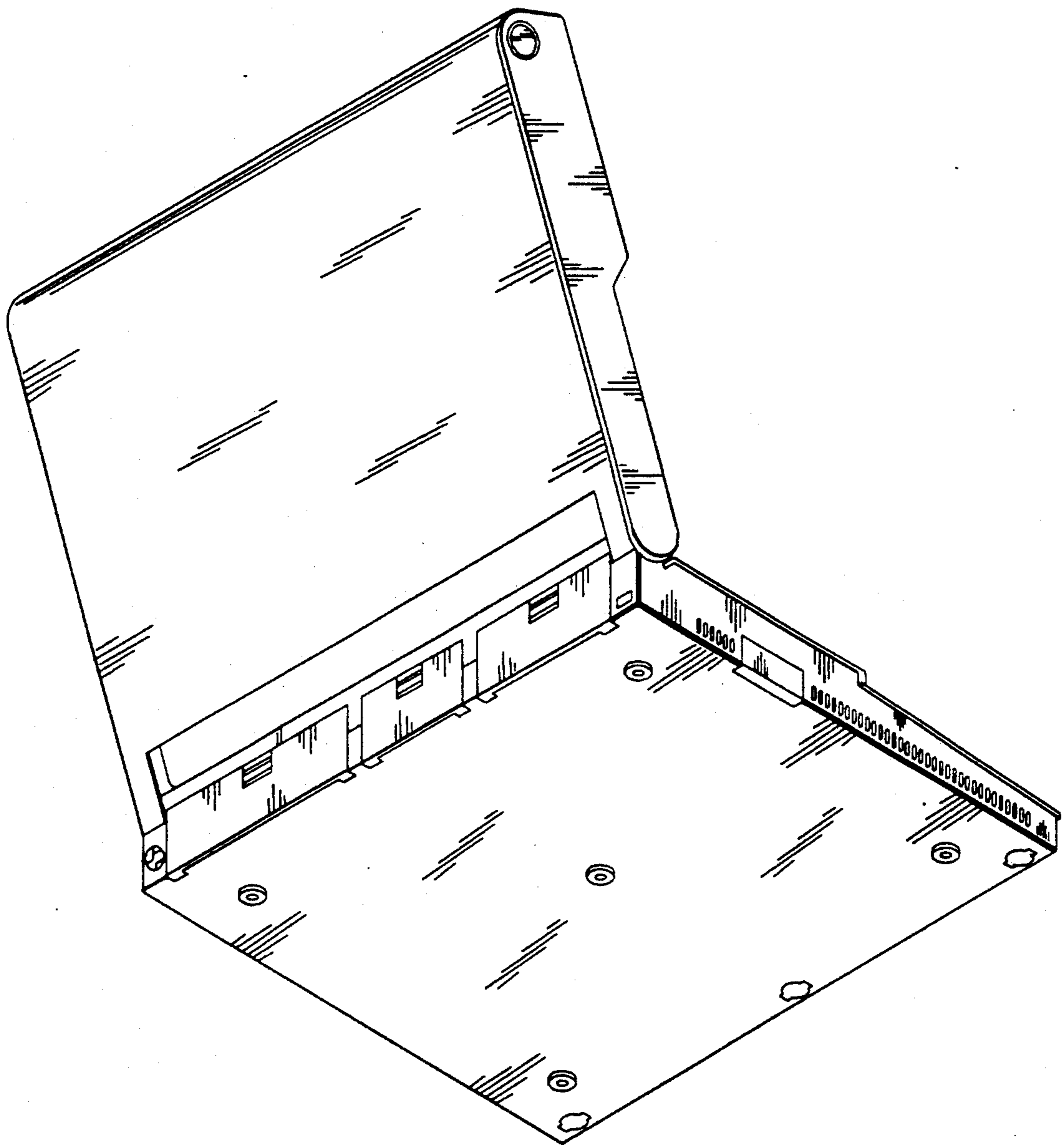

FIG. 2

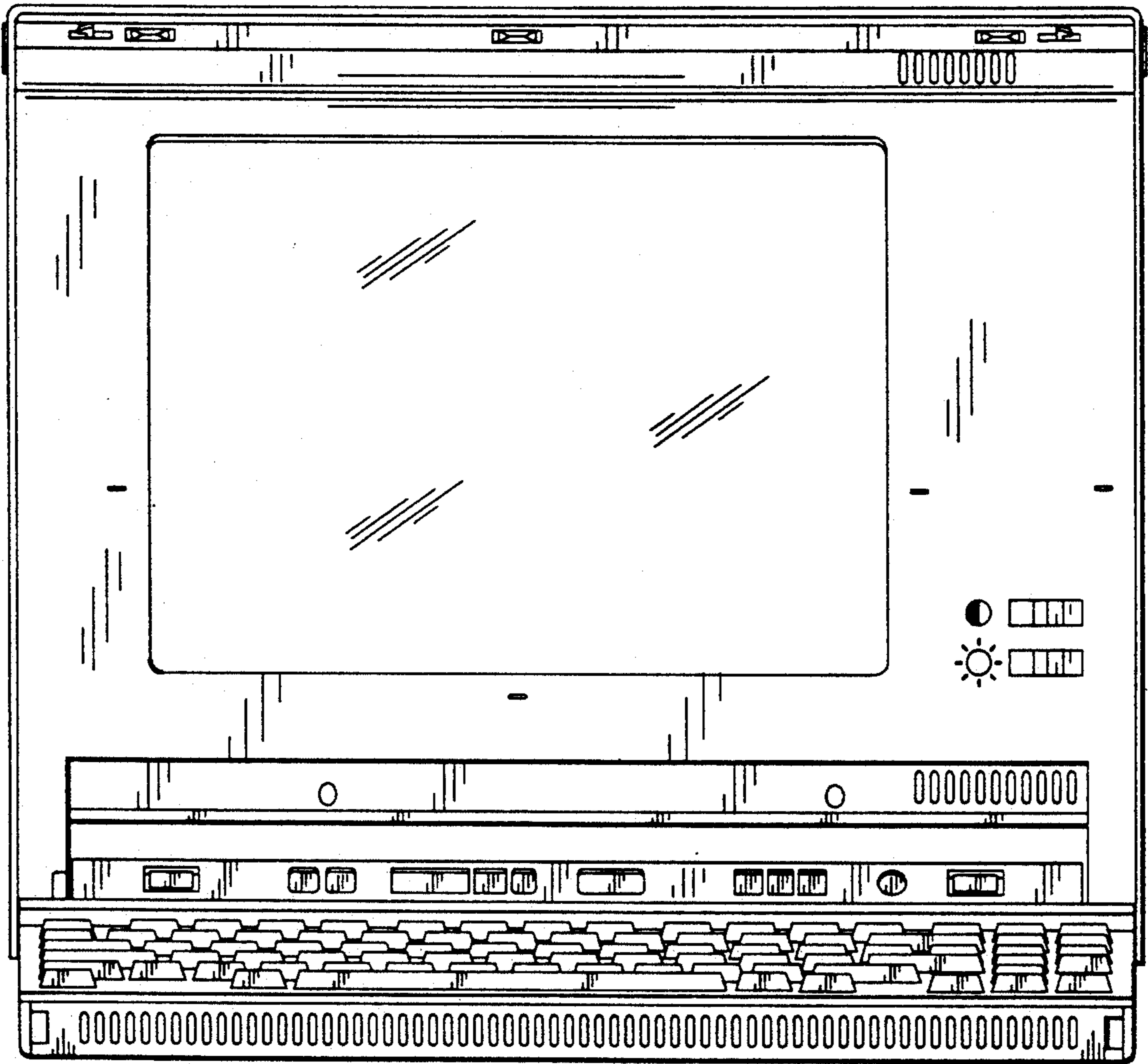

FIG. 3

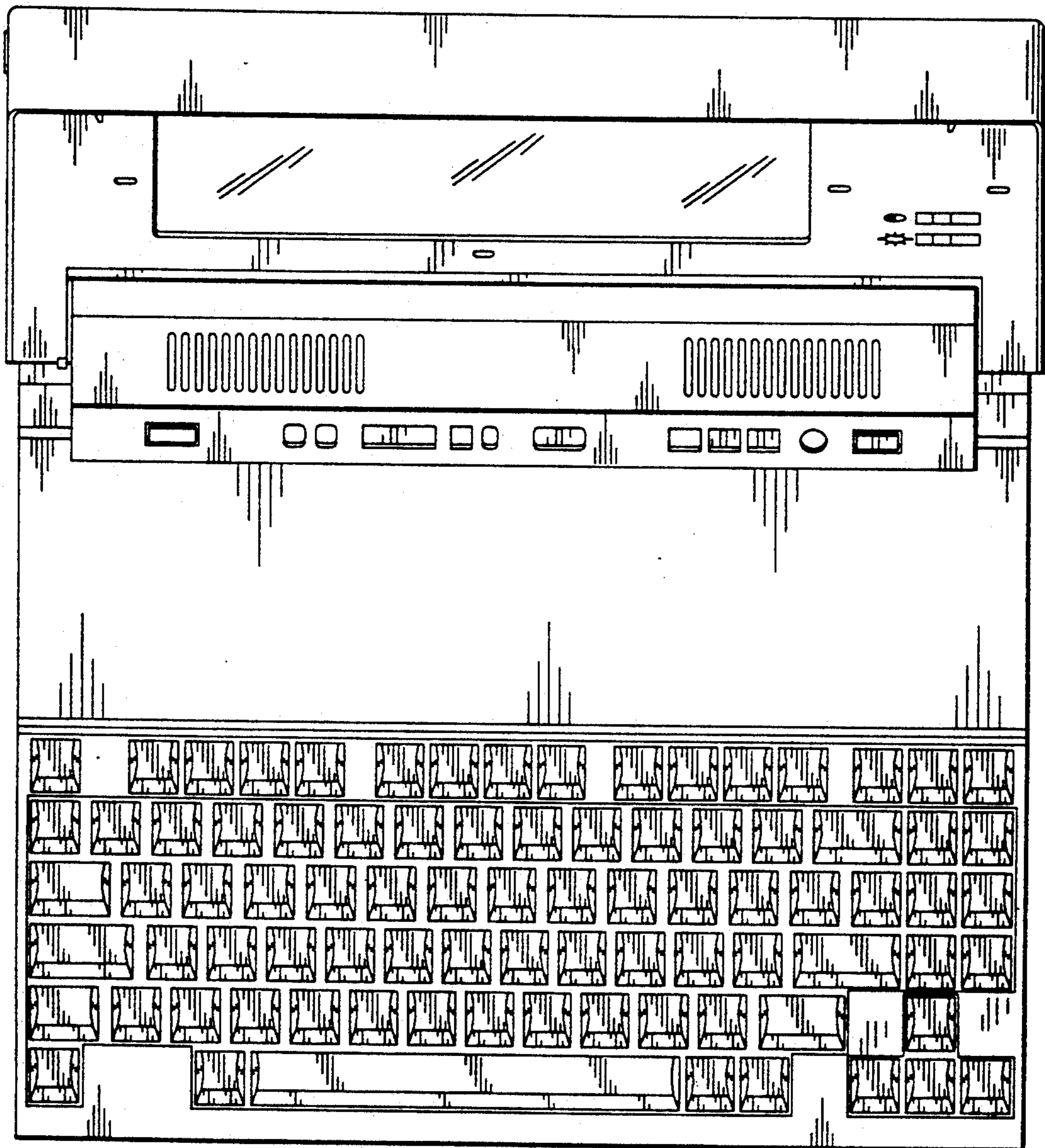

FIG. 4

FIG. 5

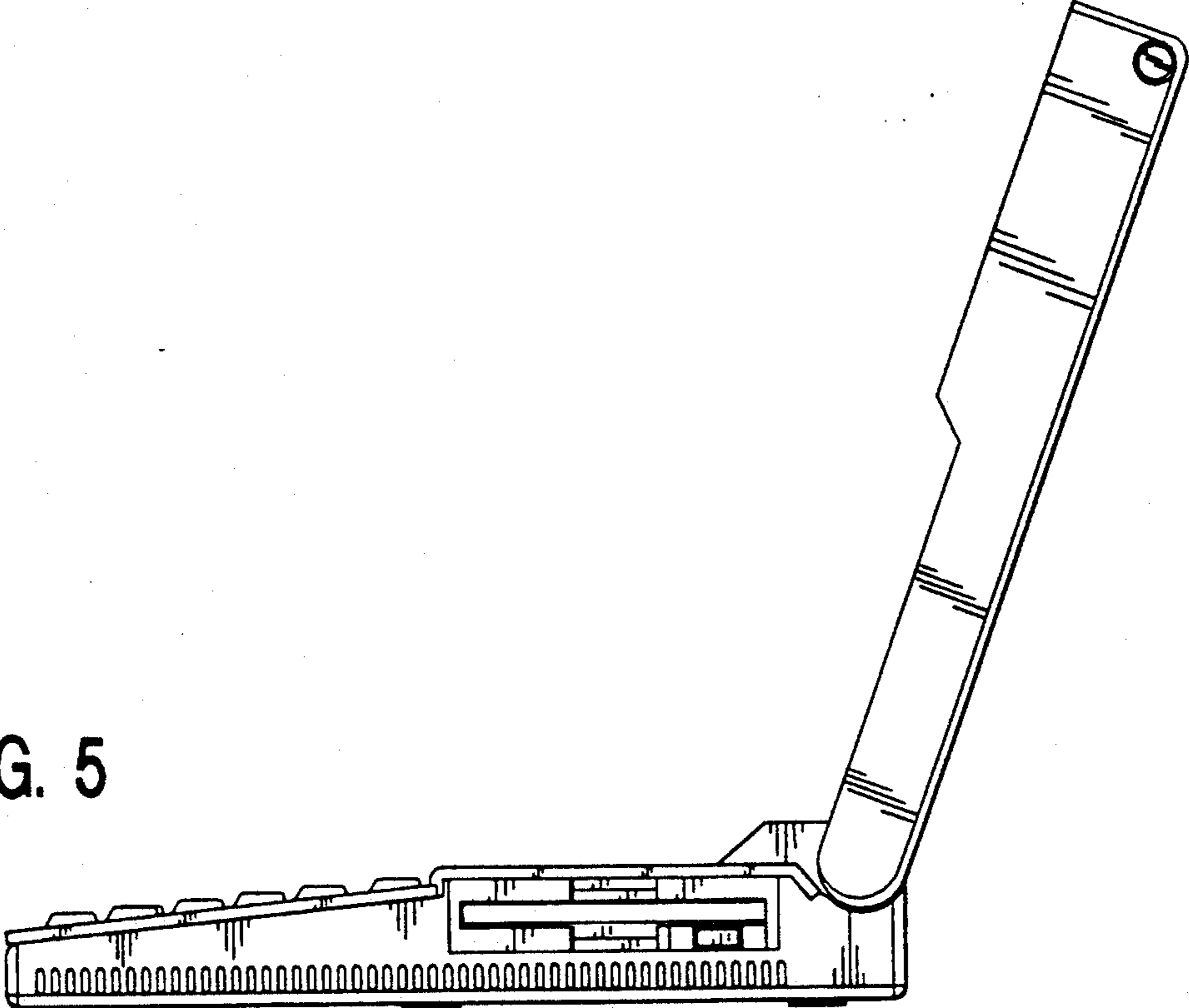
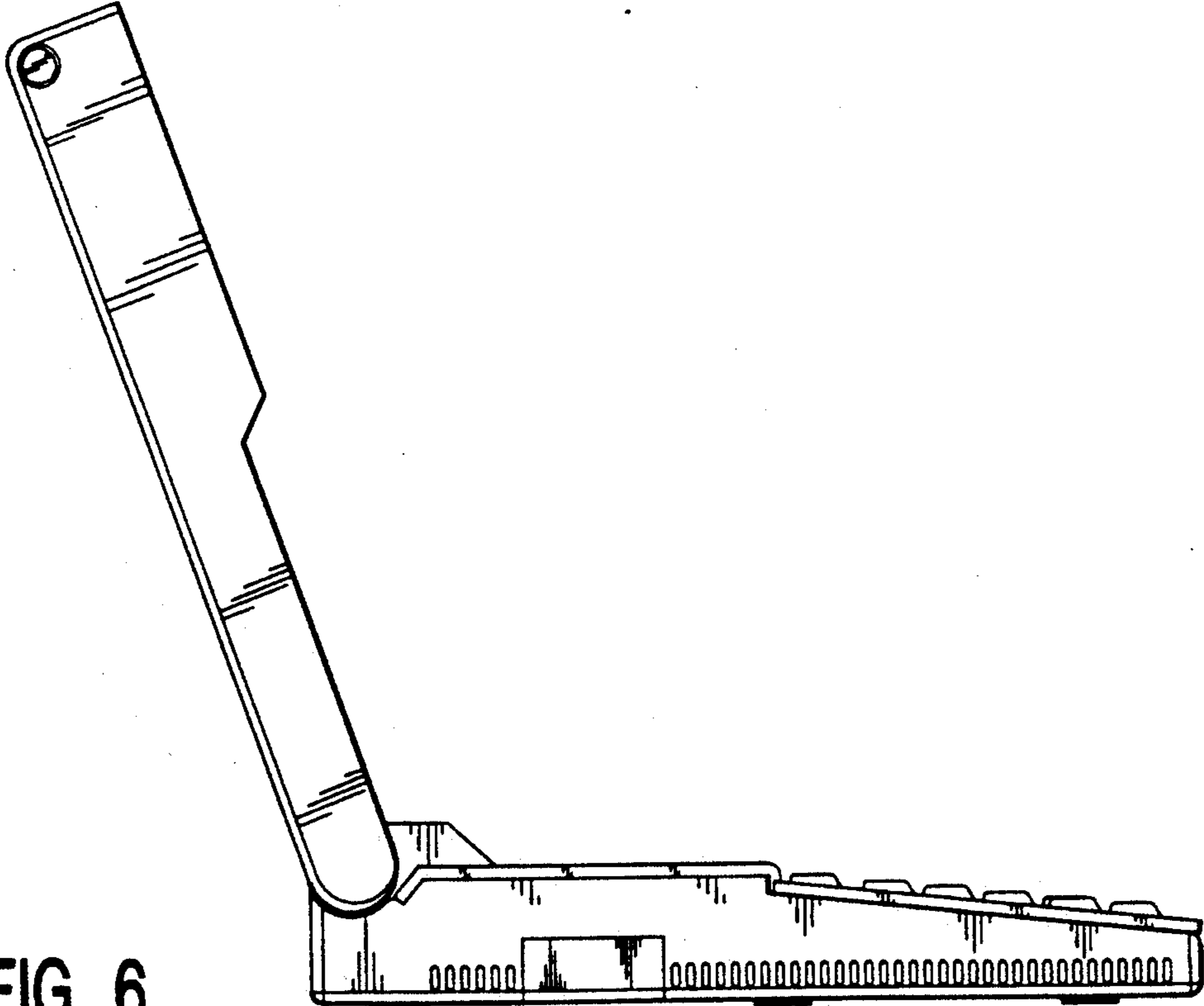

FIG. 6



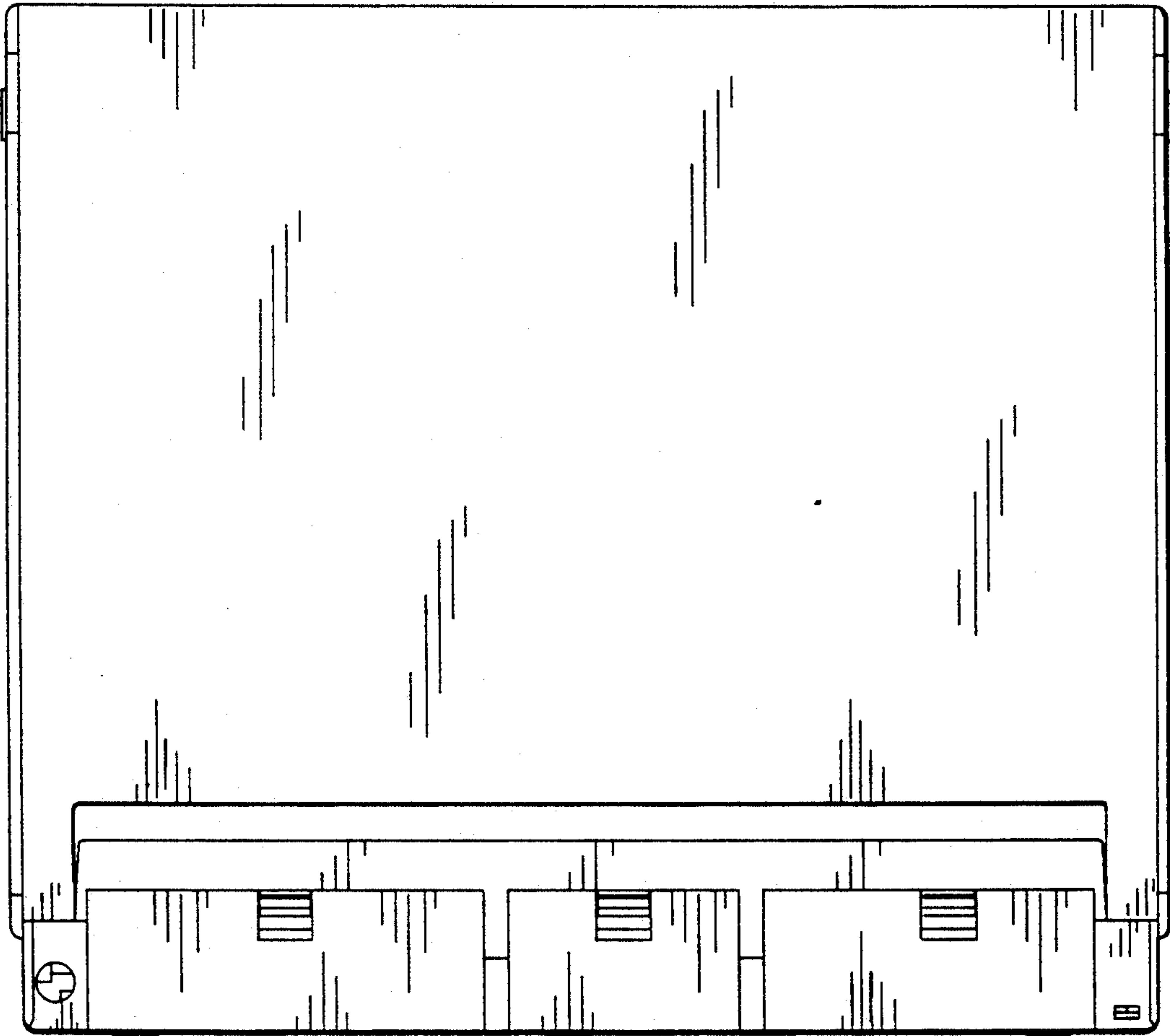

FIG. 7

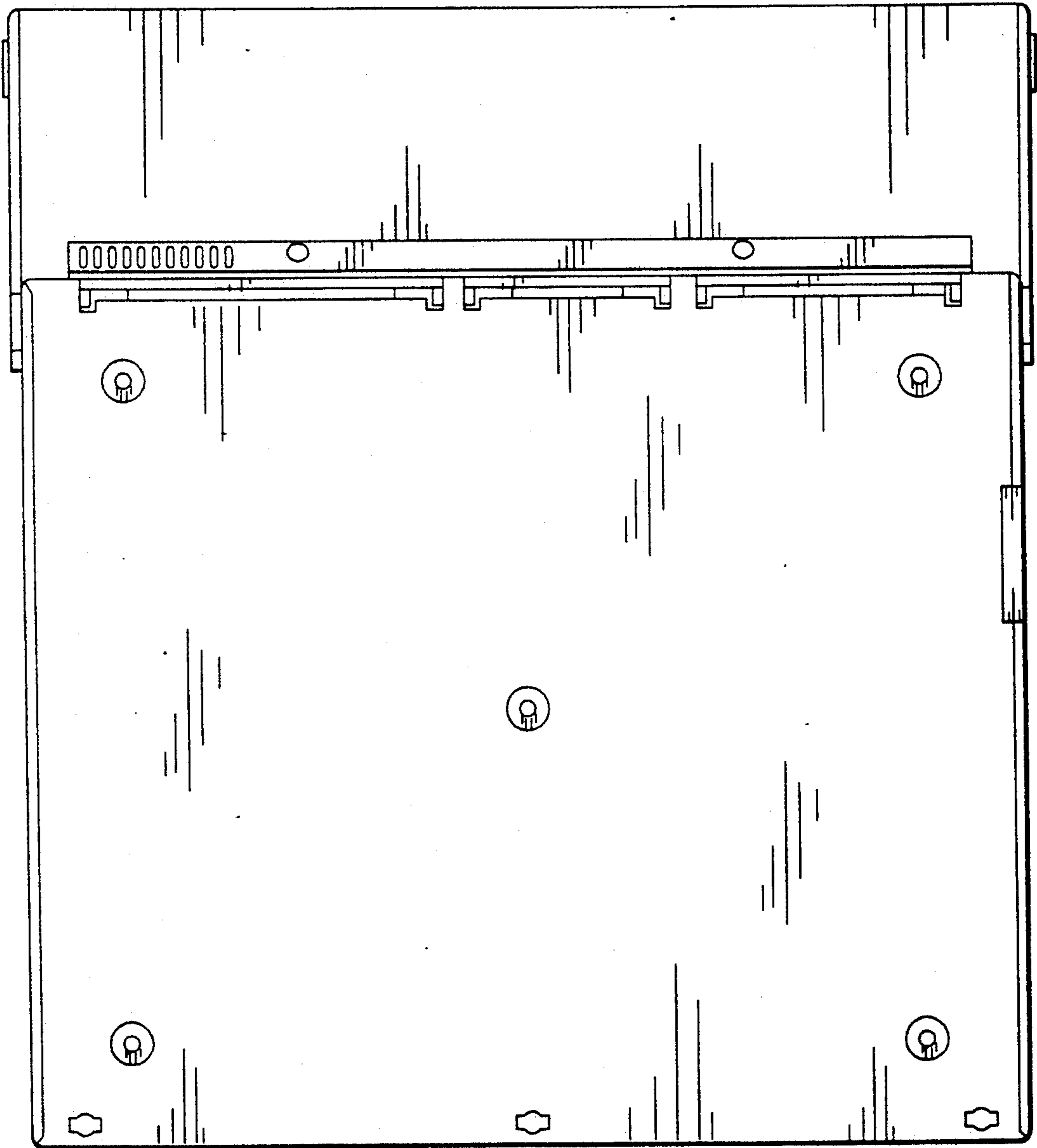

FIG. 8

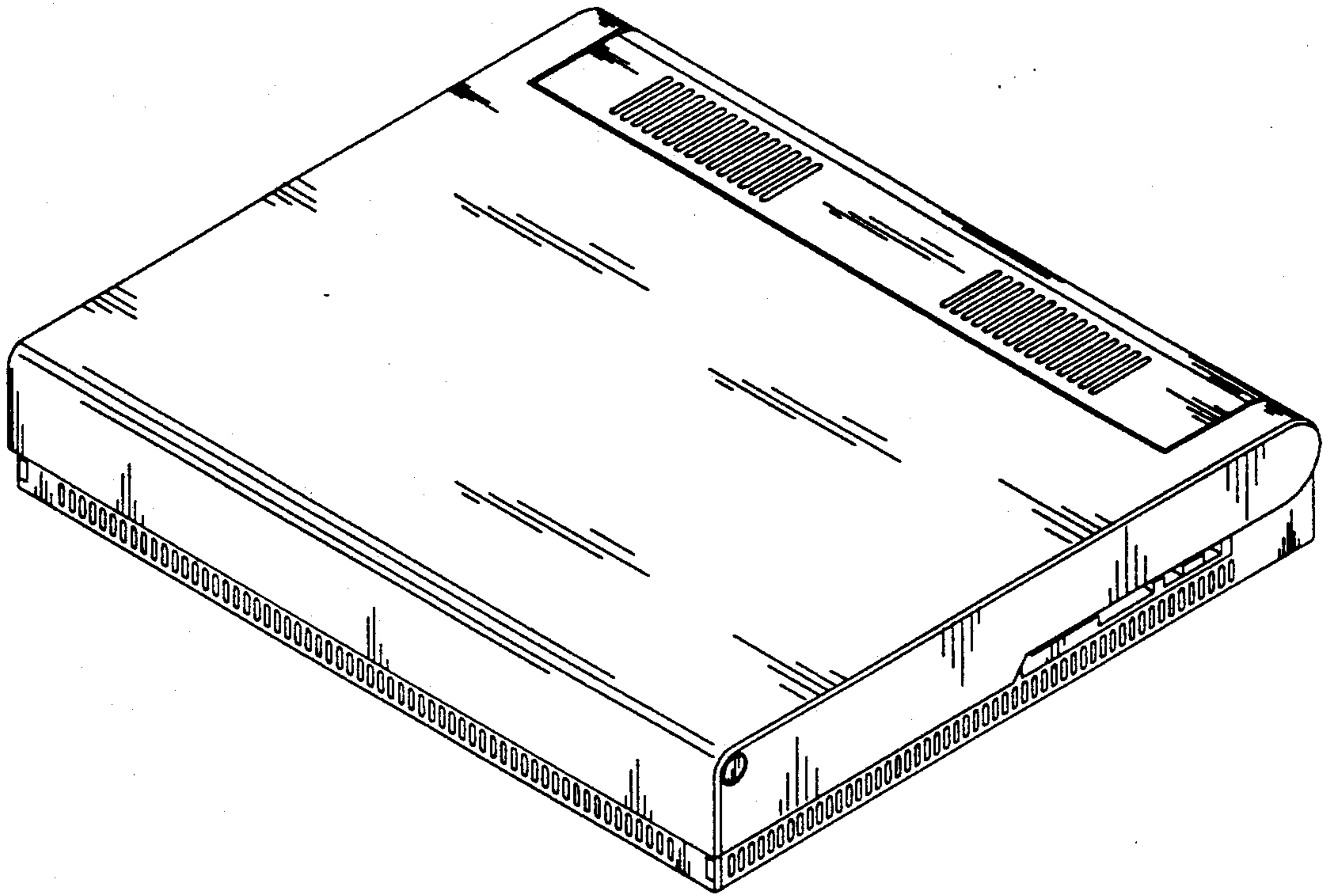

FIG. 9

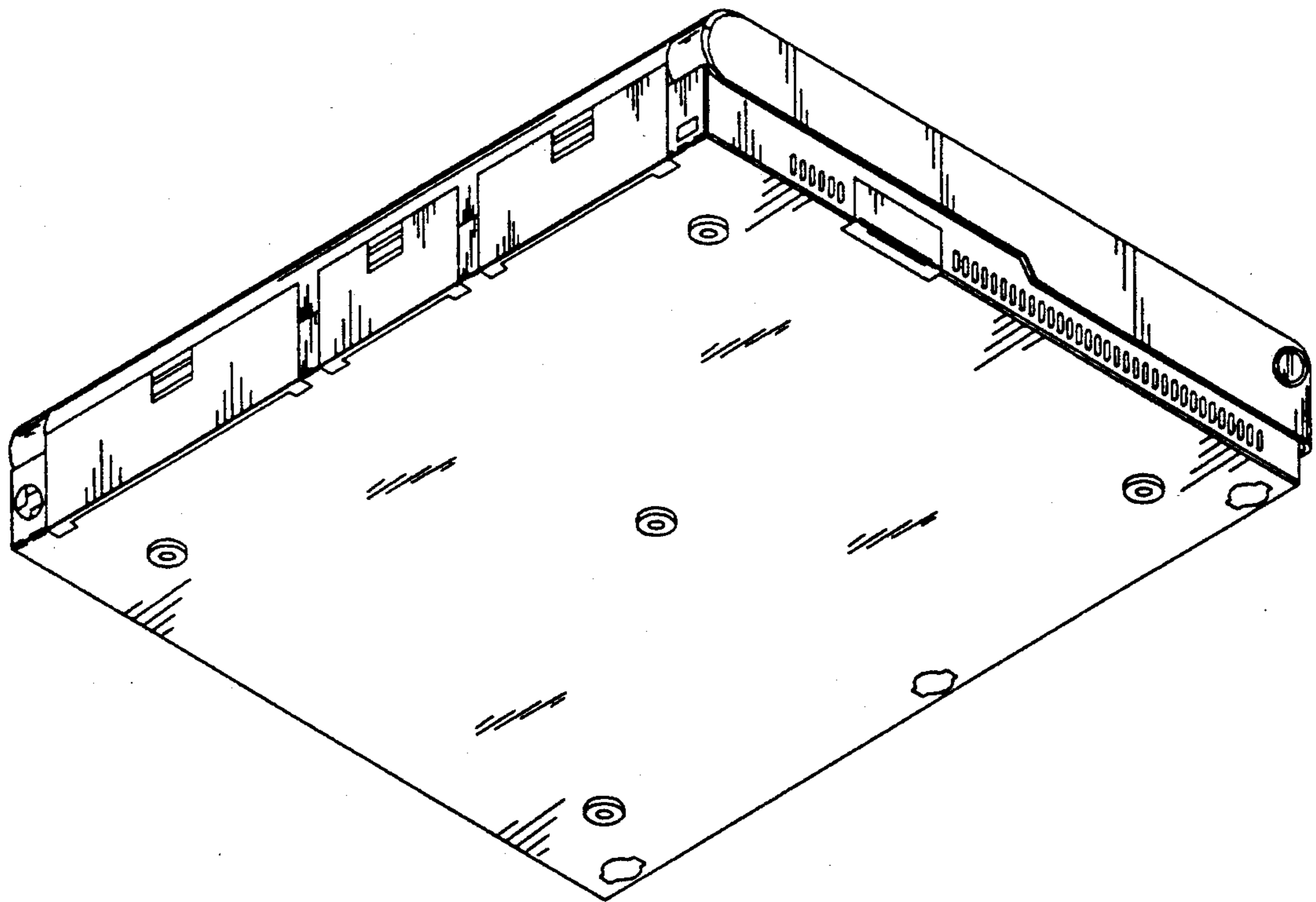

FIG. 10

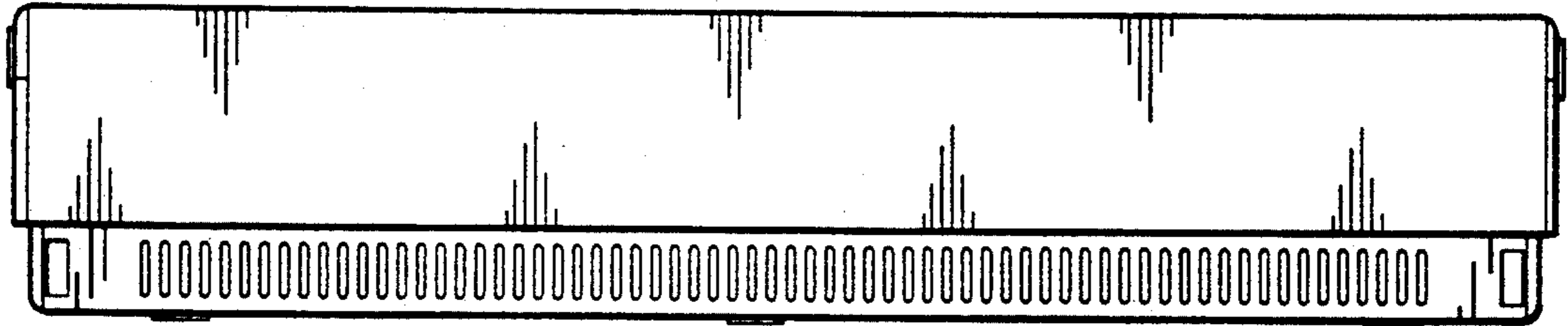

FIG. 11

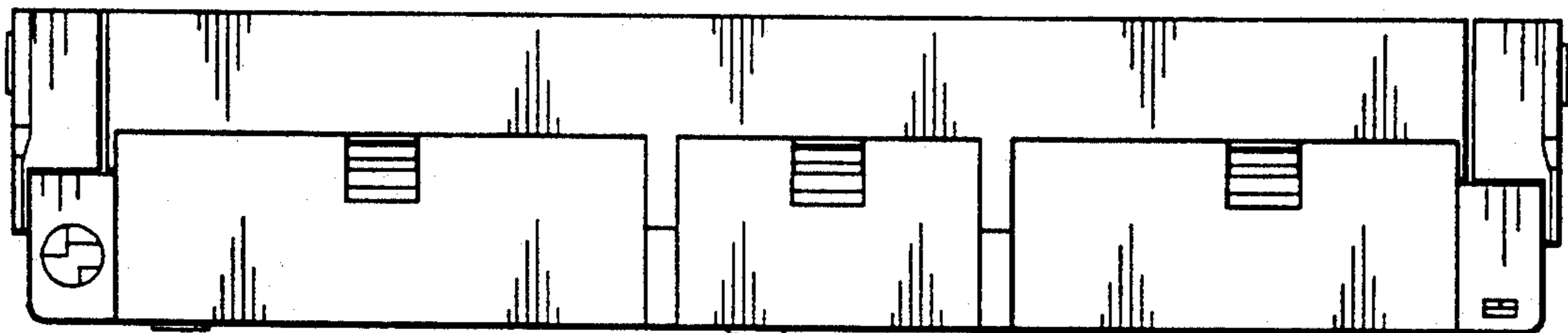

FIG. 12

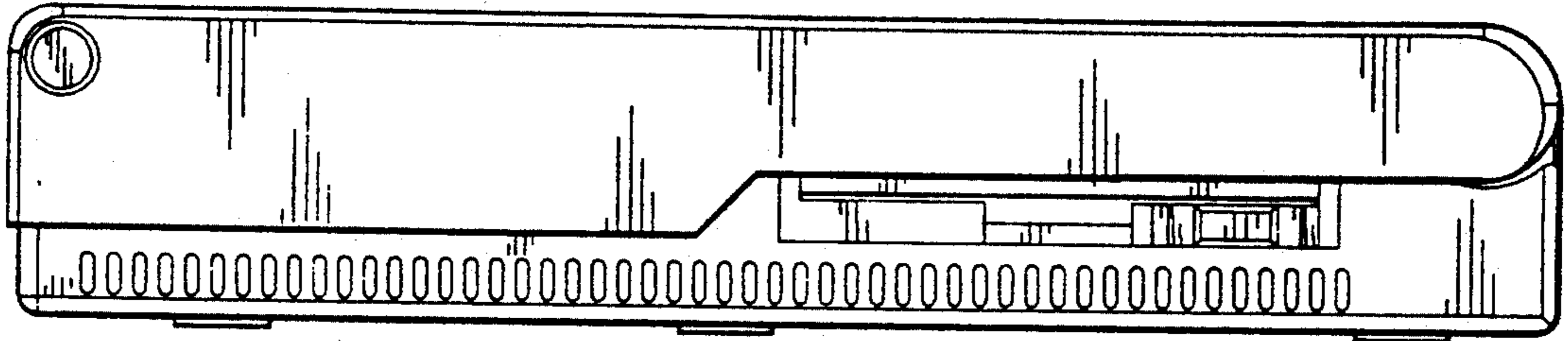

FIG. 13

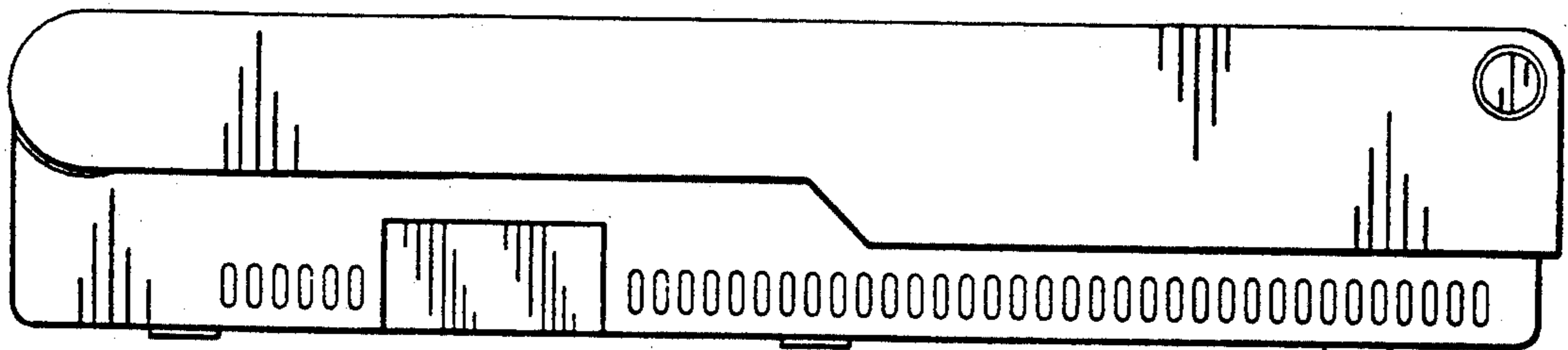

FIG. 14

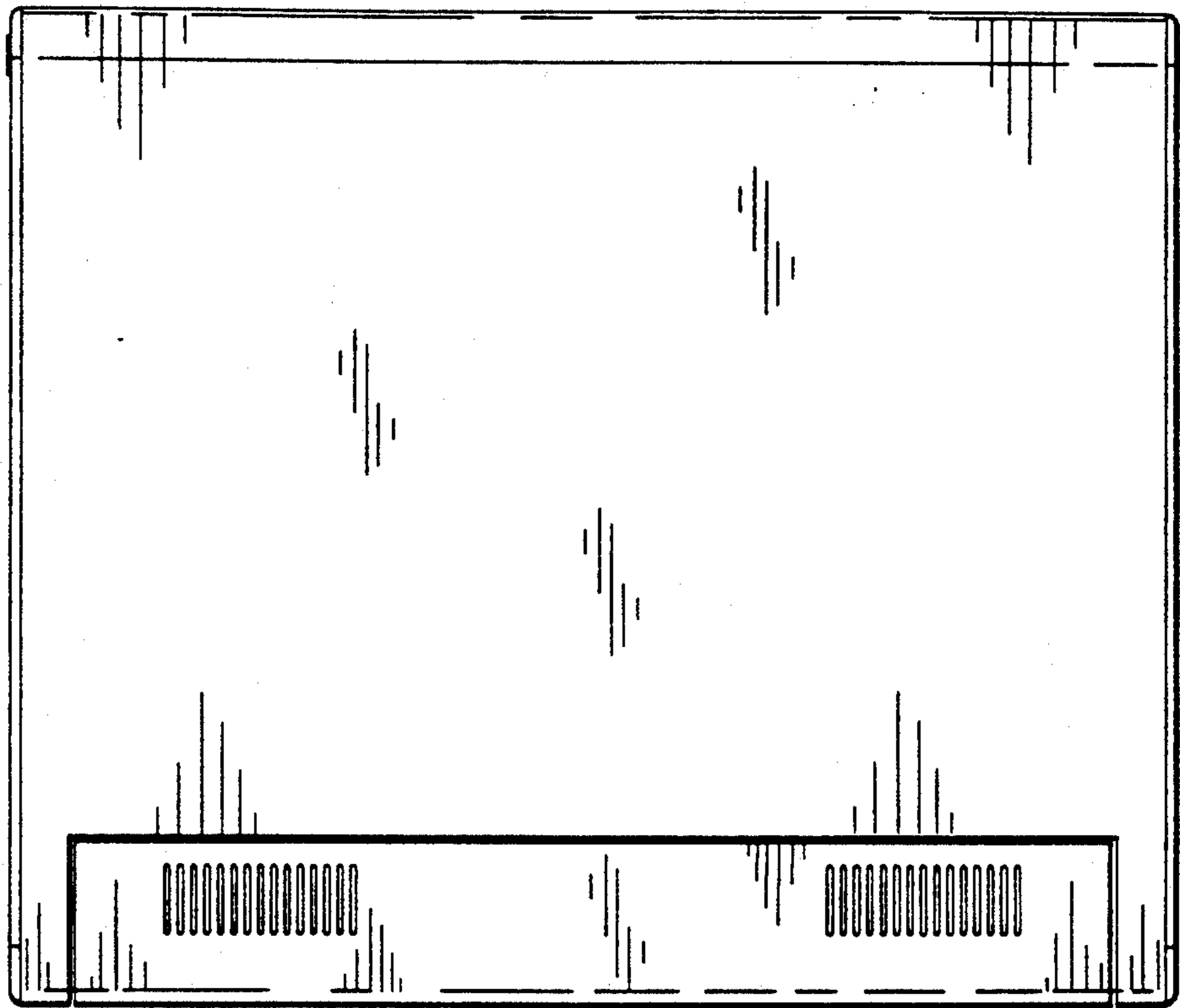

FIG. 15

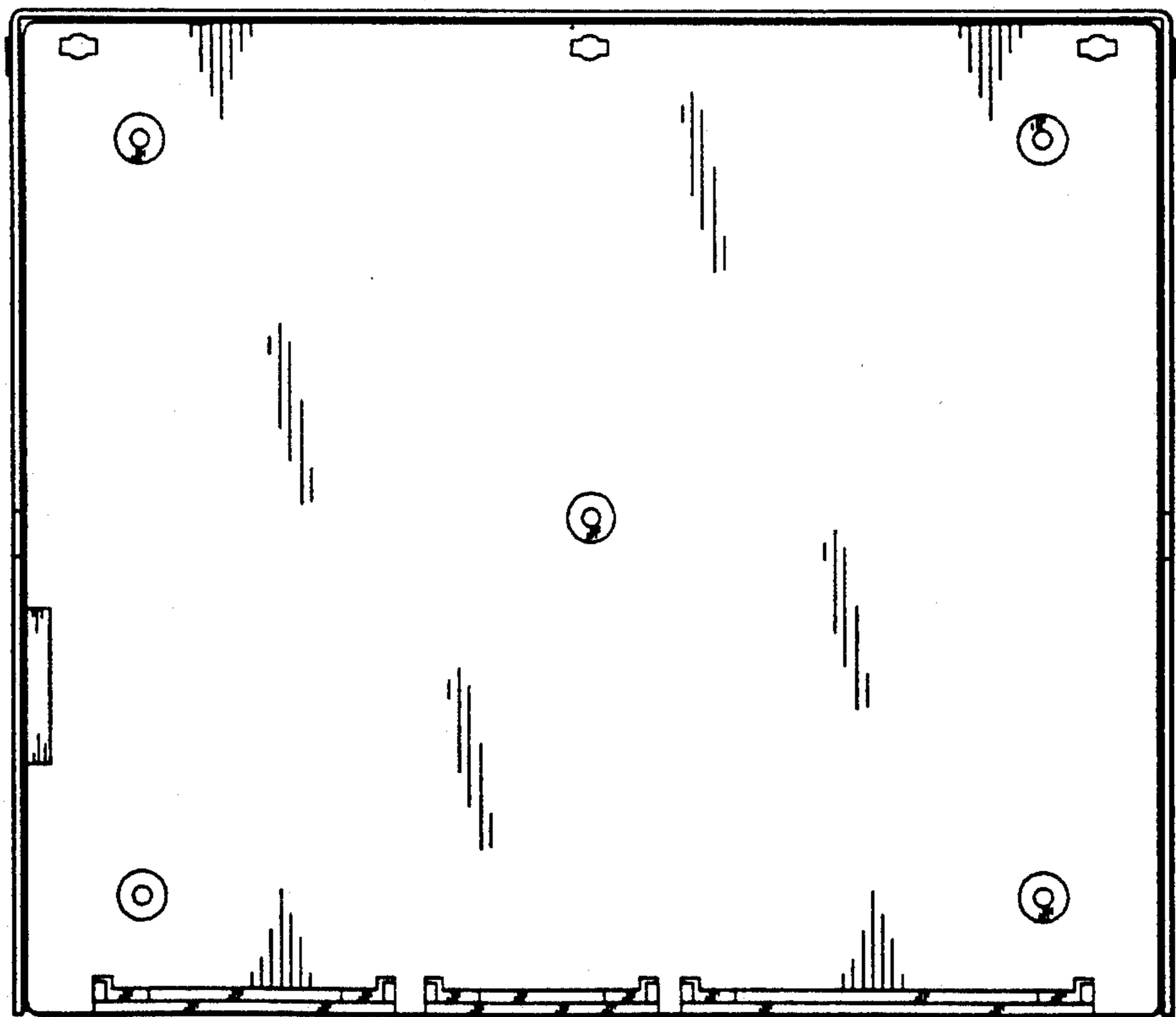

FIG. 16