



US00D339009S

# United States Patent [19]

[11] Patent Number: Des. 339,009

Evenson

[45] Date of Patent: \*\* Sep. 7, 1993

## [54] GARMENT STAND

[75] Inventor: Mel Evenson, San Pedro, Calif.

[73] Assignee: Rubbermaid Office Products Group Inc., Inglewood, Calif.

[\*\*] Term: 14 Years

[21] Appl. No.: 685,030

[22] Filed: Apr. 15, 1991

[52] U.S. Cl. .... D6/411

[58] Field of Search ..... D6/411-415, D6/455, 457-461; 211/205, 13, 30-33

## [56] References Cited

### U.S. PATENT DOCUMENTS

|            |        |                 |       |          |
|------------|--------|-----------------|-------|----------|
| D. 147,562 | 9/1947 | Kirkpatrick     | ..... | D6/411   |
| D. 171,659 | 3/1954 | Neagle          | ..... | D6/411   |
| D. 230,449 | 2/1974 | Cohen           | ..... | D6/411 X |
| D. 239,481 | 4/1976 | Beatty          | ..... | D6/458 X |
| D. 247,659 | 4/1978 | Kearney         | ..... | D6/411 X |
| D. 326,573 | 6/1992 | Crawford et al. | ..... | D6/458   |
| 1,038,198  | 9/1912 | Randall et al.  | ..... | 211/205  |
| 1,928,292  | 9/1933 | Lazarus         | ..... | 211/30   |
| 2,010,093  | 8/1935 | Lazarus         | ..... | 211/30   |

### OTHER PUBLICATIONS

Sell Sheet, Coat Trees, Vogel Peterson Furniture Company, 7373 Hunt Avenue, Garden Grove, CA 92641. It is believed that the product depicted herein has been on sale for more than 1 year prior to the application date of this instant application.

P. 19, Coat Trees, Peter Pepper Products, Inc., 17929 South Susan Road, P.O. Box 5769, Compton, CA 90224. It is believed that the product depicted herein

has been on sale for more than 1 year prior to the application date of this instant application.

P. 10, Coat Trees, Artistic Office Products, 721 East 133 Street, Bronx, NY 10454. It is believed that the product depicted herein has been on sale for more than 1 year prior to the application date of this instant application. Pp. 6 and 7, Coat Trees, Magnuson Group, address unknown. It is believed that the product depicted herein has been on sale for more than 1 year prior to the application date of this instant application.

Pp. 4 and 5, Coat Trees, Glaro, Inc., 735 Old Willets Path, P.O. Box 3039, Smithtown, NY 11787-7919. It is believed that the product depicted herein has been on sale for more than 1 year prior to the application date of this instant application.

*Primary Examiner*—Carmen H. Vales-Lado

*Attorney, Agent, or Firm*—Richard B. O'Planick; Lisa B. Riedesel

## [57] CLAIM

The ornamental design for a garment stand, as shown and described.

## DESCRIPTION

FIG. 1 is a top plan view of a garment stand showing my new design;

FIG. 2 is a bottom plan view;

FIG. 3 is a side elevational view taken at section line 3-3 of FIG. 1;

FIG. 4 is a side elevational view taken at section line 4-4 of FIG. 1;

FIG. 5 is a side elevational view taken at section 5-5 of FIG. 1; and,

FIG. 6 is a perspective view thereof.

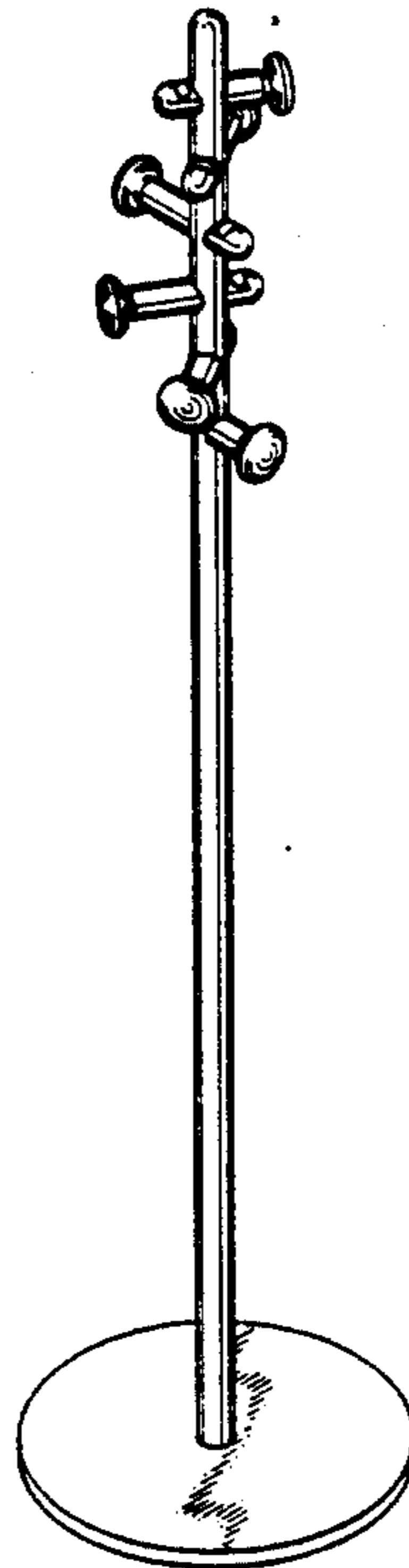

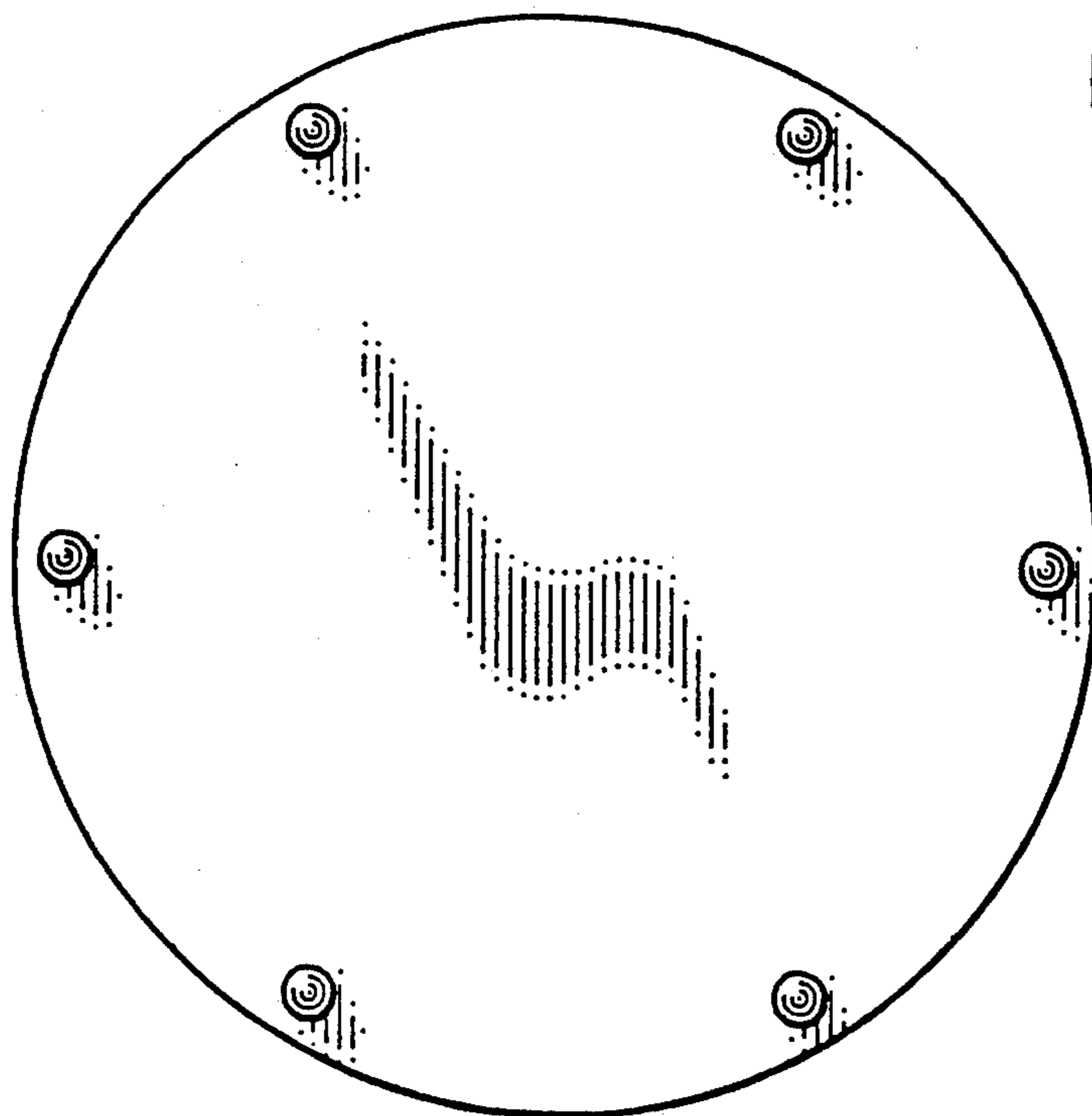
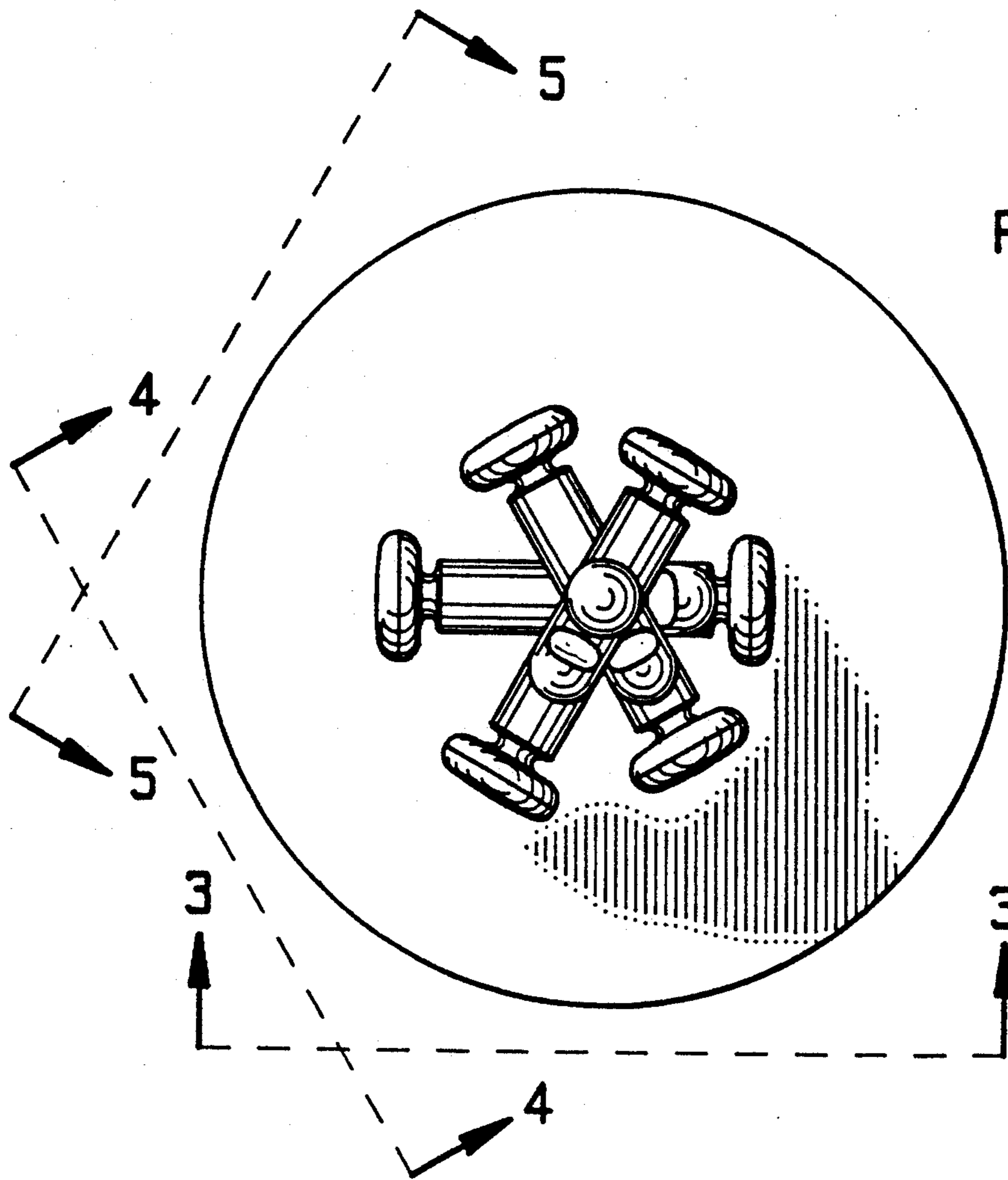

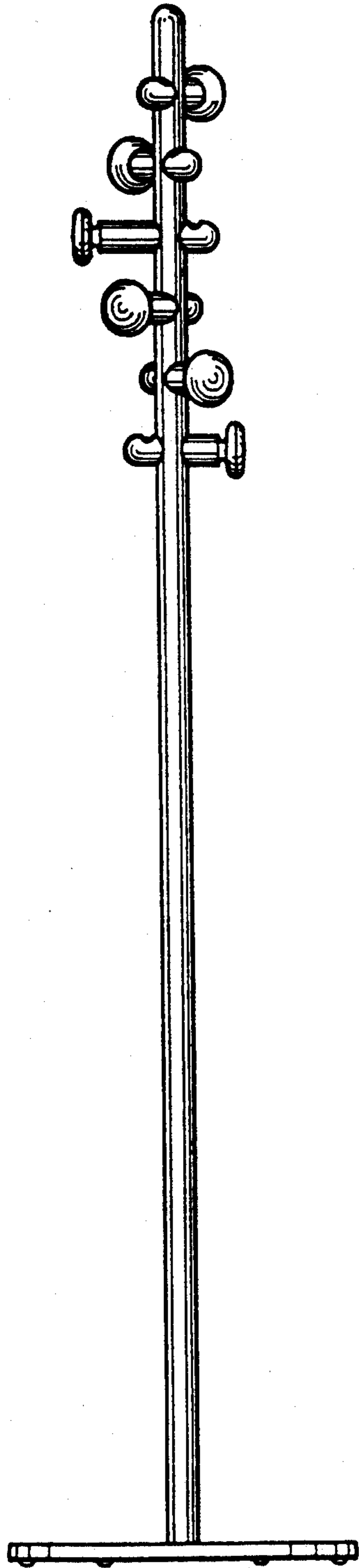

FIG. 3

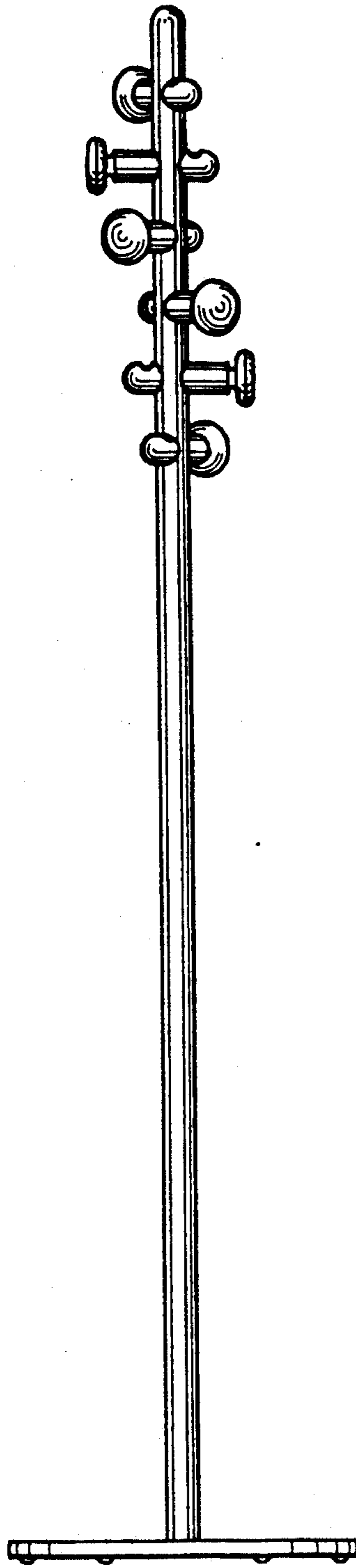

FIG. 4

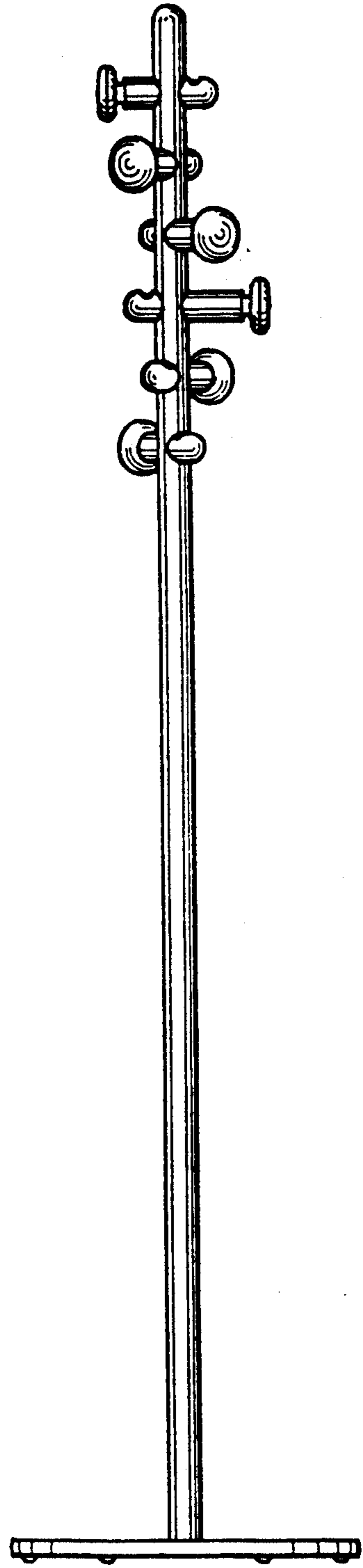

FIG. 5

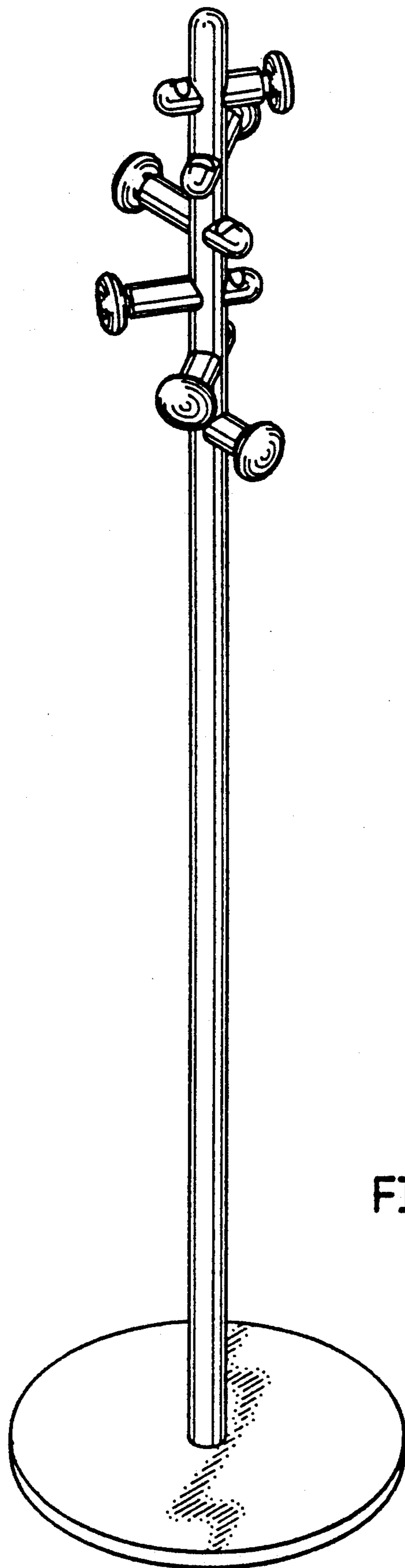

FIG. 6