



US00D338911S

United States Patent [19]

[11] Patent Number: **Des. 338,911**

Ujita et al.

[45] Date of Patent: **** Aug. 31, 1993**

[54] **PRINTING HEAD FOR PRINTER**

[75] Inventors: **Toshihiko Ujita, Yamato; Kenjiro Watanabe, Tokyo; Koji Yamakawa, Yokohama; Kayomi Sato, Kawasaki; Masanori Takenouchi, Yokohama, all of Japan**

[73] Assignee: **Canon Kabushiki Kaisha, Tokyo, Japan**

[**] Term: **14 Years**

[21] Appl. No.: **897,527**

[22] Filed: **Jun. 12, 1992**

[30] **Foreign Application Priority Data**

Dec. 13, 1991 [JP] Japan 3-37714

[52] U.S. Cl. **D18/56**

[58] Field of Search D18/56, 40; 400/471; 101/333-335; 346/75, 140 R, 140 PD; 206/462

[56] **References Cited**

U.S. PATENT DOCUMENTS

- D. 313,427 1/1991 Saeki D18/56
- D. 314,006 1/1991 Abe et al. D18/56
- D. 325,743 4/1992 Kojima et al. D18/50
- D. 326,111 5/1992 Otsuka et al. D18/56
- D. 331,775 12/1992 Umino et al. D18/56

- D. 333,675 3/1993 Chiovitti D18/56
- 4,131,899 12/1978 Christov 346/140 R
- 4,183,031 1/1980 Kyser et al. 346/140 R
- 4,992,802 2/1991 Dion et al. 346/140 R
- 5,162,817 11/1992 Tajika et al. 346/140 R
- 5,187,498 2/1993 Burger 346/140 R

FOREIGN PATENT DOCUMENTS

- 0003958 1/1988 Japan 346/140 R
- 0004954 1/1988 Japan 346/140 R

Primary Examiner—A. Hugo Word
Assistant Examiner—Cathy Anne MacCormac
Attorney, Agent, or Firm—Fitzpatrick, Cella, Harper & Scinto

[57] **CLAIM**

The ornamental design for a printing head for printer, as shown and described.

DESCRIPTION

FIG. 1 is a front elevational view of a printing head for printer showing our new design;
FIG. 2 is a rear elevational view thereof;
FIG. 3 is a top plan view thereof;
FIG. 4 is a bottom plan view thereof;
FIG. 5 is a left side elevational view thereof;
FIG. 6 is a right side elevational view thereof; and,
FIG. 7 is a perspective view thereof.

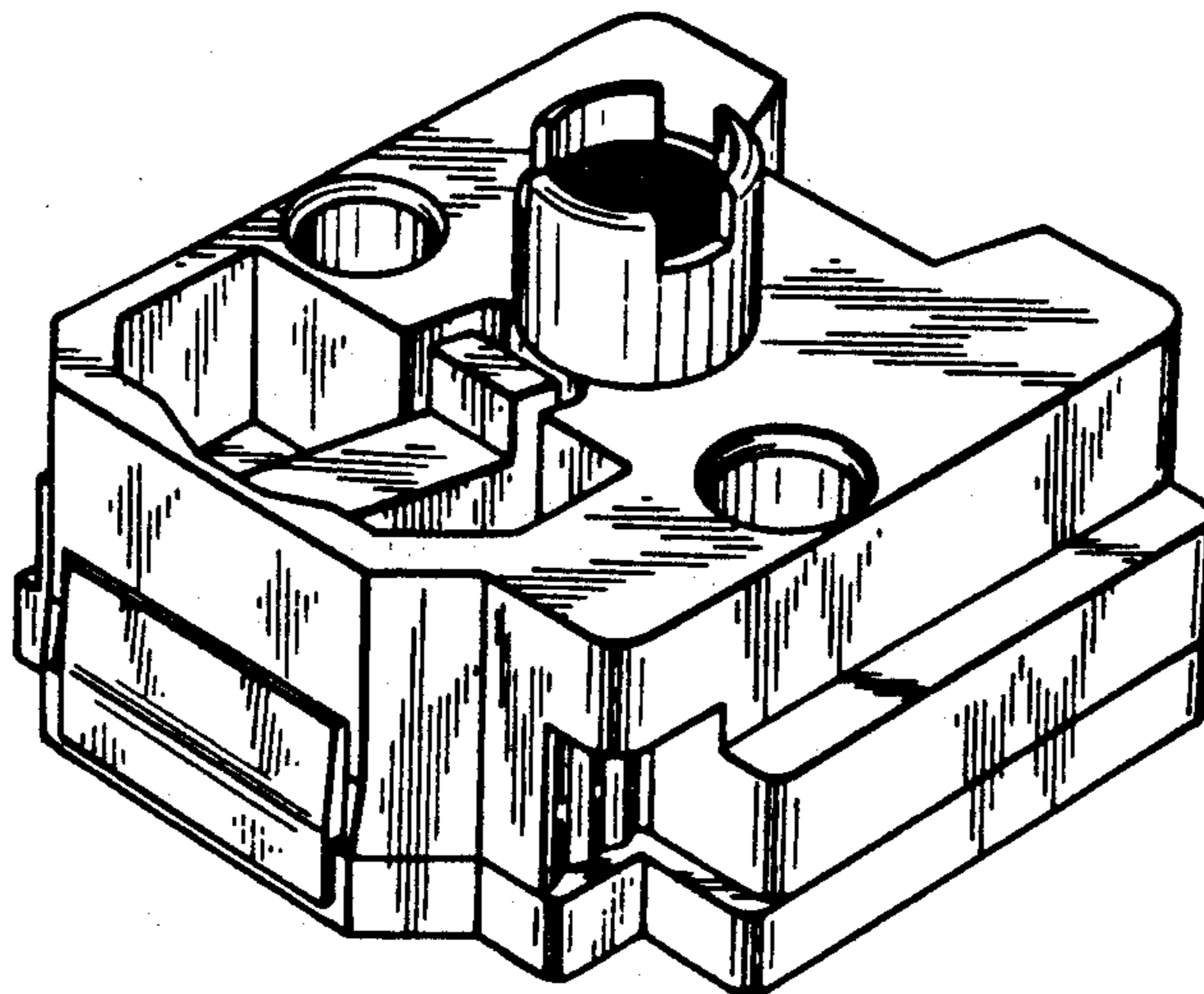

FIG. 1

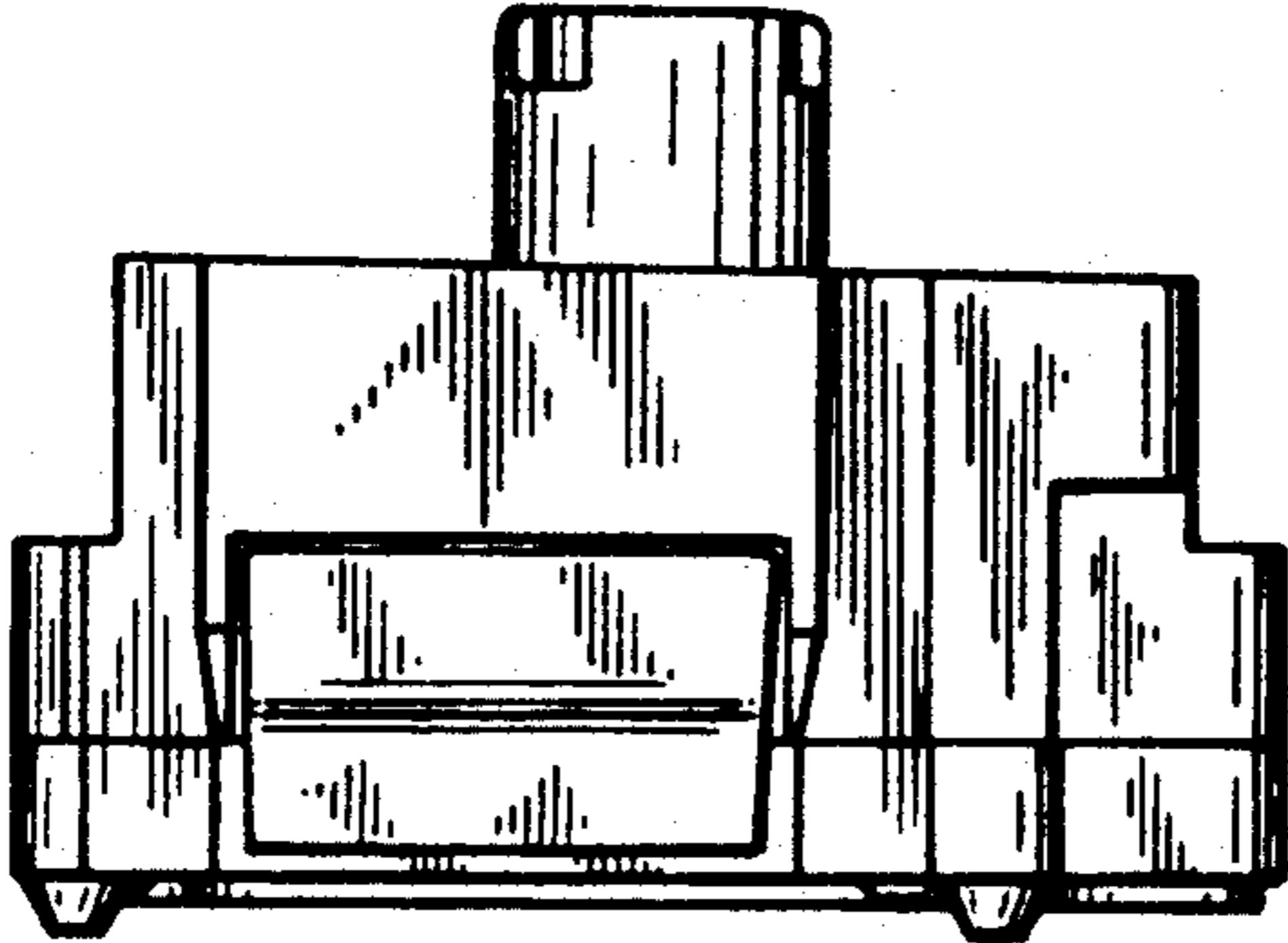

FIG. 2

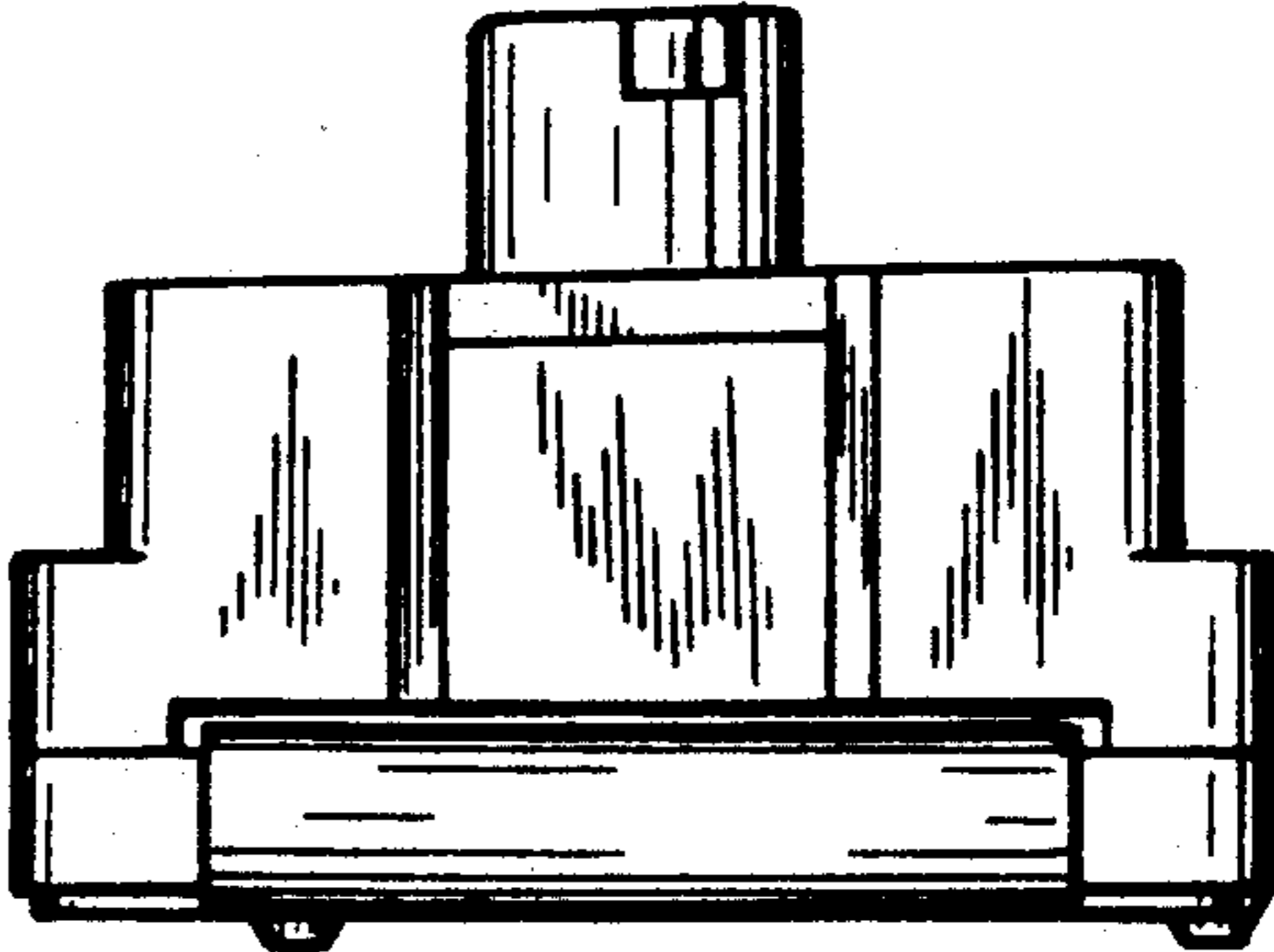

FIG. 3

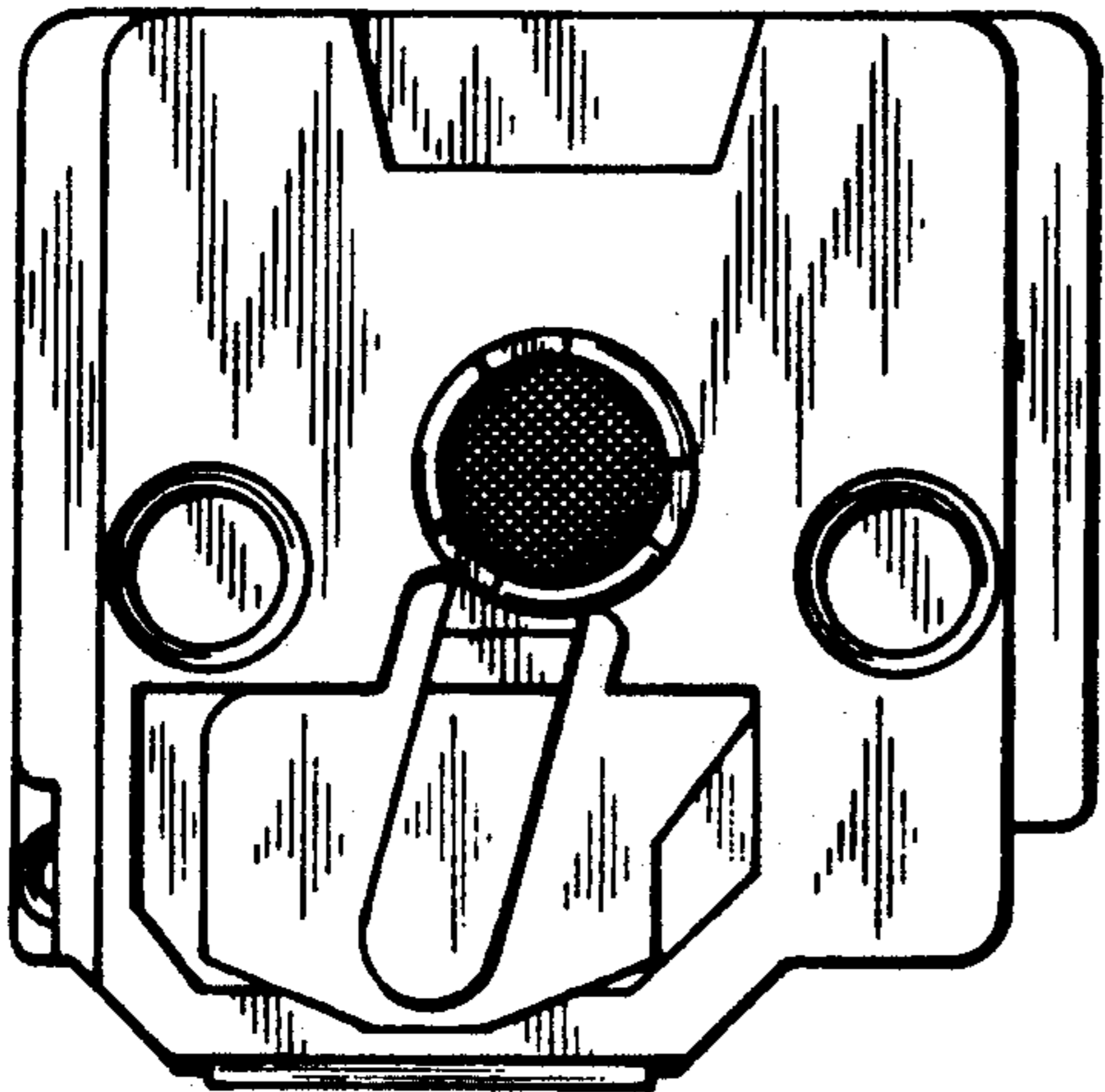

FIG. 4

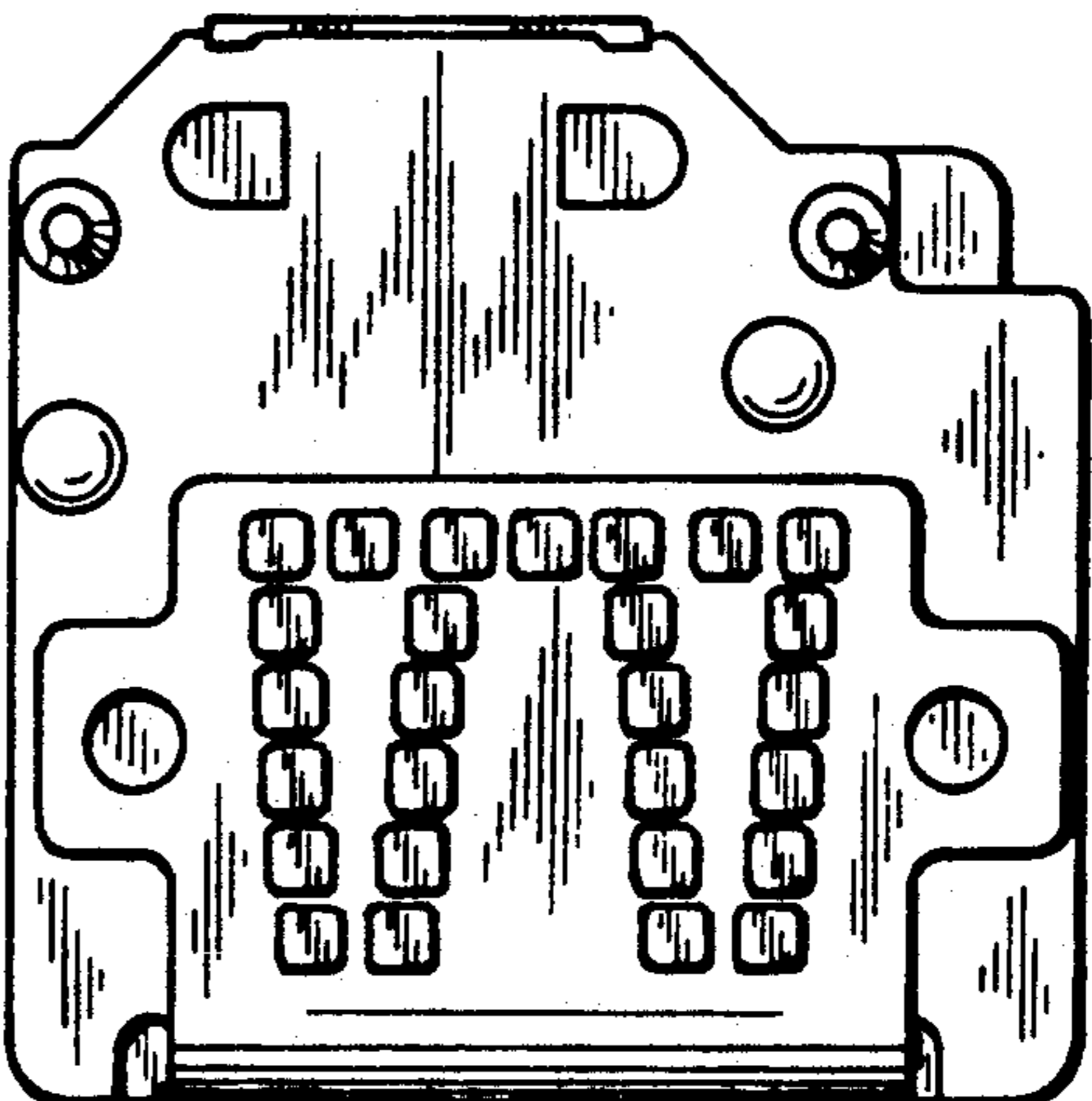

FIG. 5

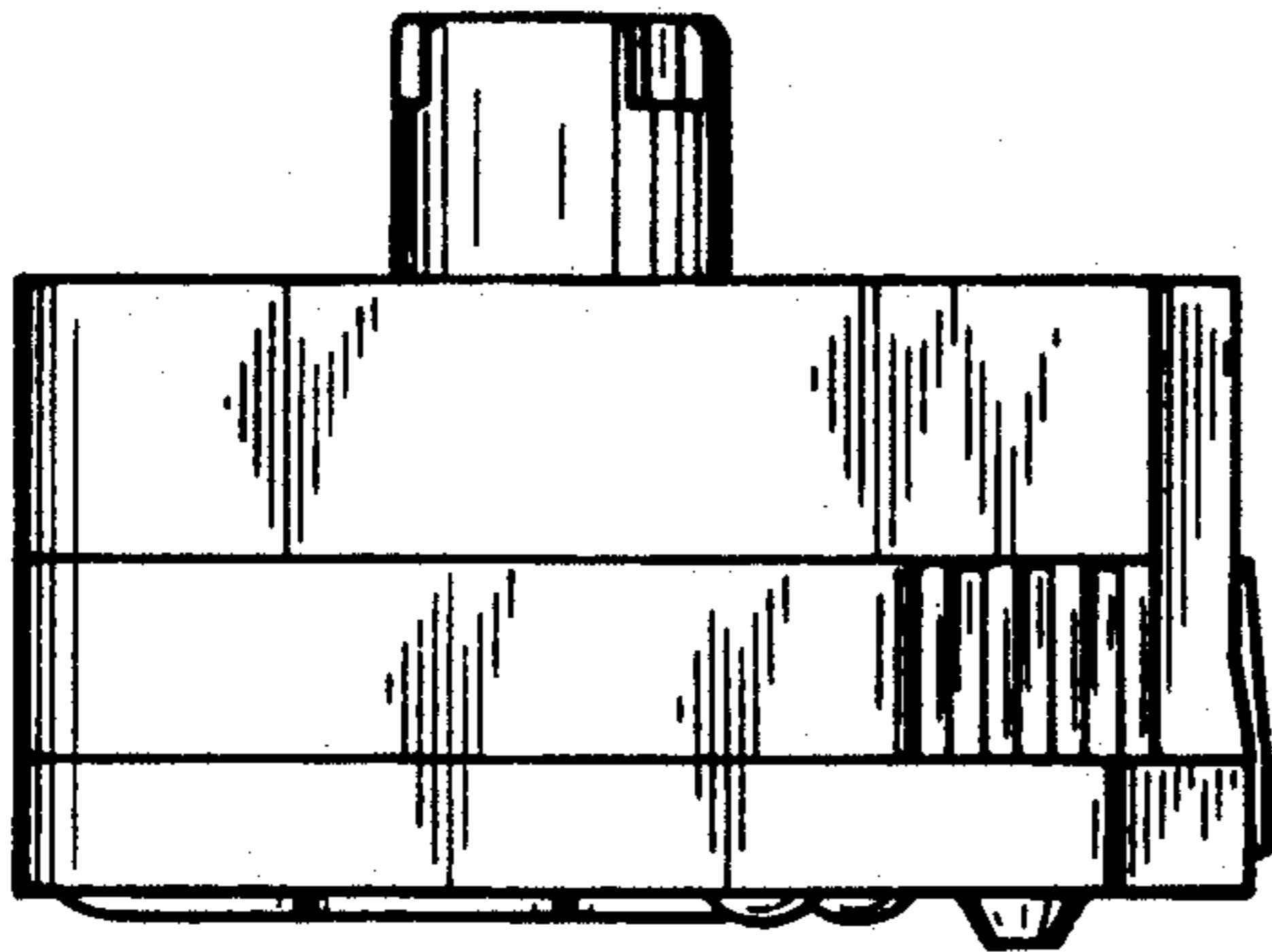

FIG. 6

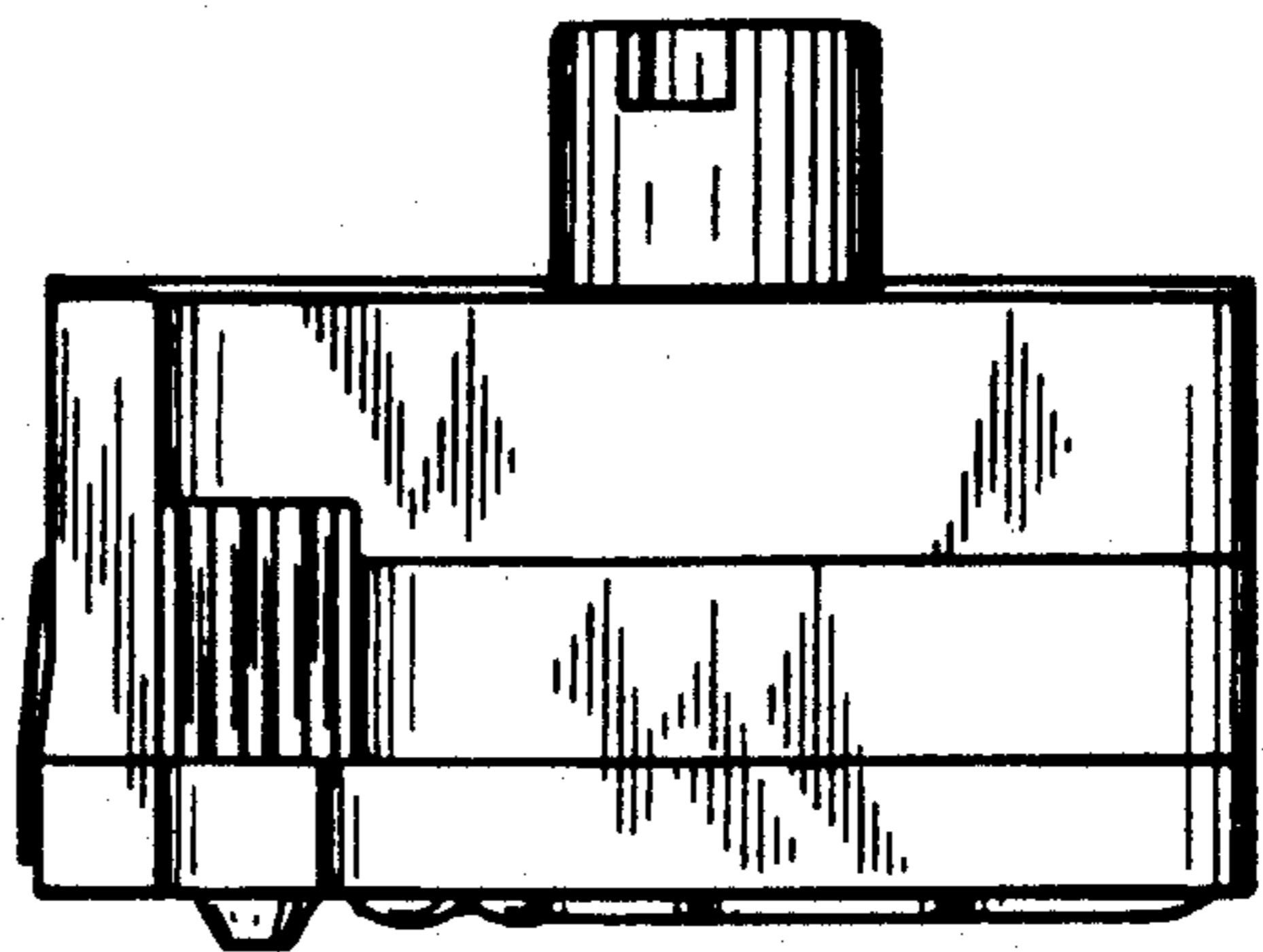

FIG. 7

