



US00D338757S

# United States Patent [19]

[11] Patent Number: **Des. 338,757**

Harrison

[45] Date of Patent: **\*\* Aug. 24, 1993**

[54] TRASH CONTAINER

[76] Inventor: **William K. Harrison**, 1270 Electric,  
Apt. #209, Lincoln Park, Mich.  
48146

[\*\*] Term: **14 Years**

[21] Appl. No.: **642,364**

[22] Filed: **Jan. 17, 1991**

[52] U.S. Cl. .... **D34/7; D34/1**

[58] Field of Search ..... **D34/1-11;**  
**220/908, 909; 232/1 R**

[56] **References Cited**

### U.S. PATENT DOCUMENTS

- D. 311,801 10/1990 Kullenberg ..... D34/1
- D. 326,342 5/1992 Doxey et al. .... D34/7

*Primary Examiner*—Kay H. Chin  
*Attorney, Agent, or Firm*—Alex Rhodes

### [57] CLAIM

The ornamental design for a trash container, as shown and described.

### DESCRIPTION

FIG. 1 is a plan view of a trash container showing my new design;  
 FIG. 2 is a front elevational view thereof;  
 FIG. 3 is a bottom view thereof;  
 FIG. 4 is a side elevational view thereof;  
 FIG. 5 is a cross-sectional view taken on the line 5—5 in FIG. 4;  
 FIG. 6 is a cross-sectional view taken on the line 6—6 in FIG. 4; and,  
 FIG. 7 is a cross-sectional view taken on the line 7—7 in FIG. 4.

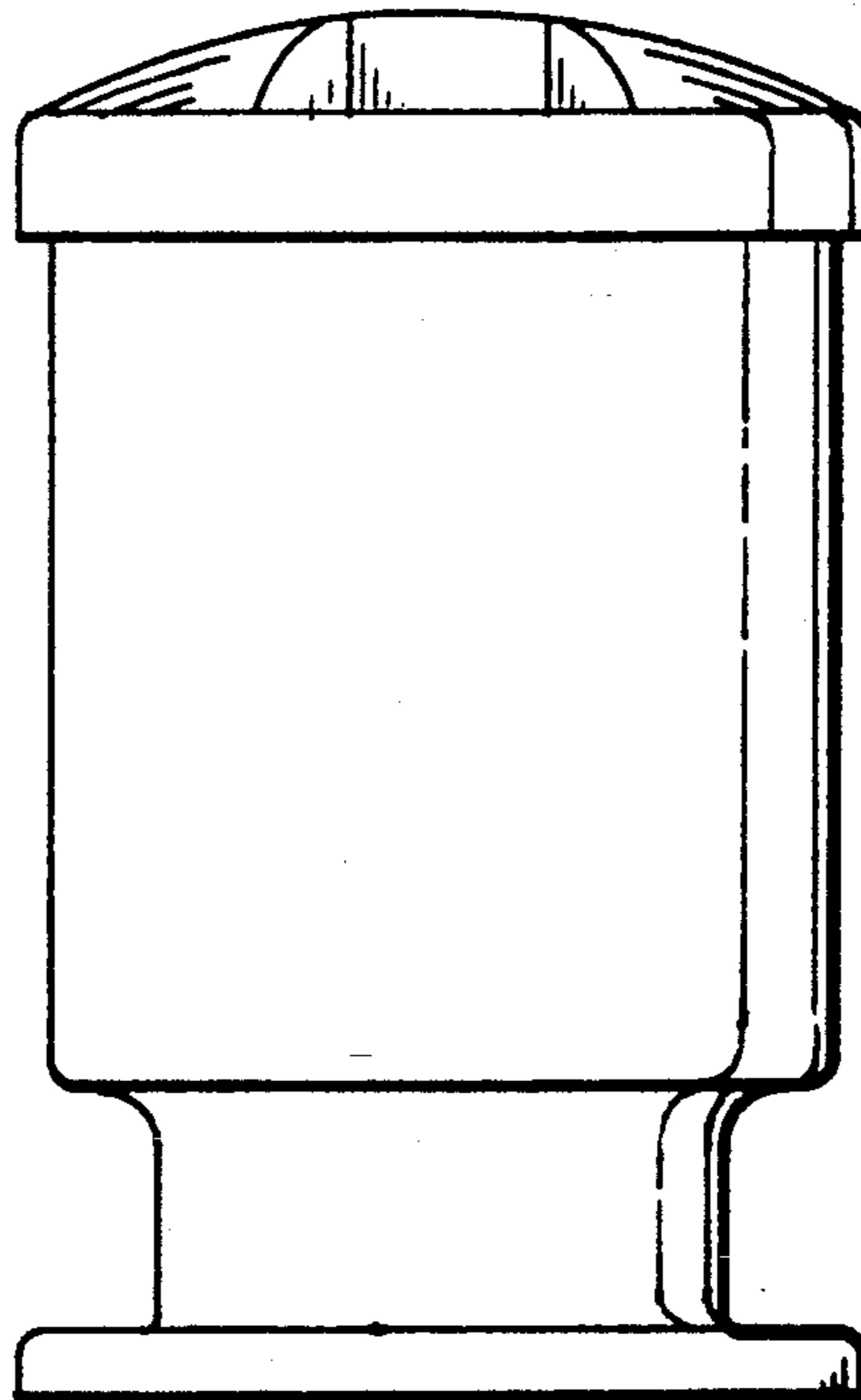

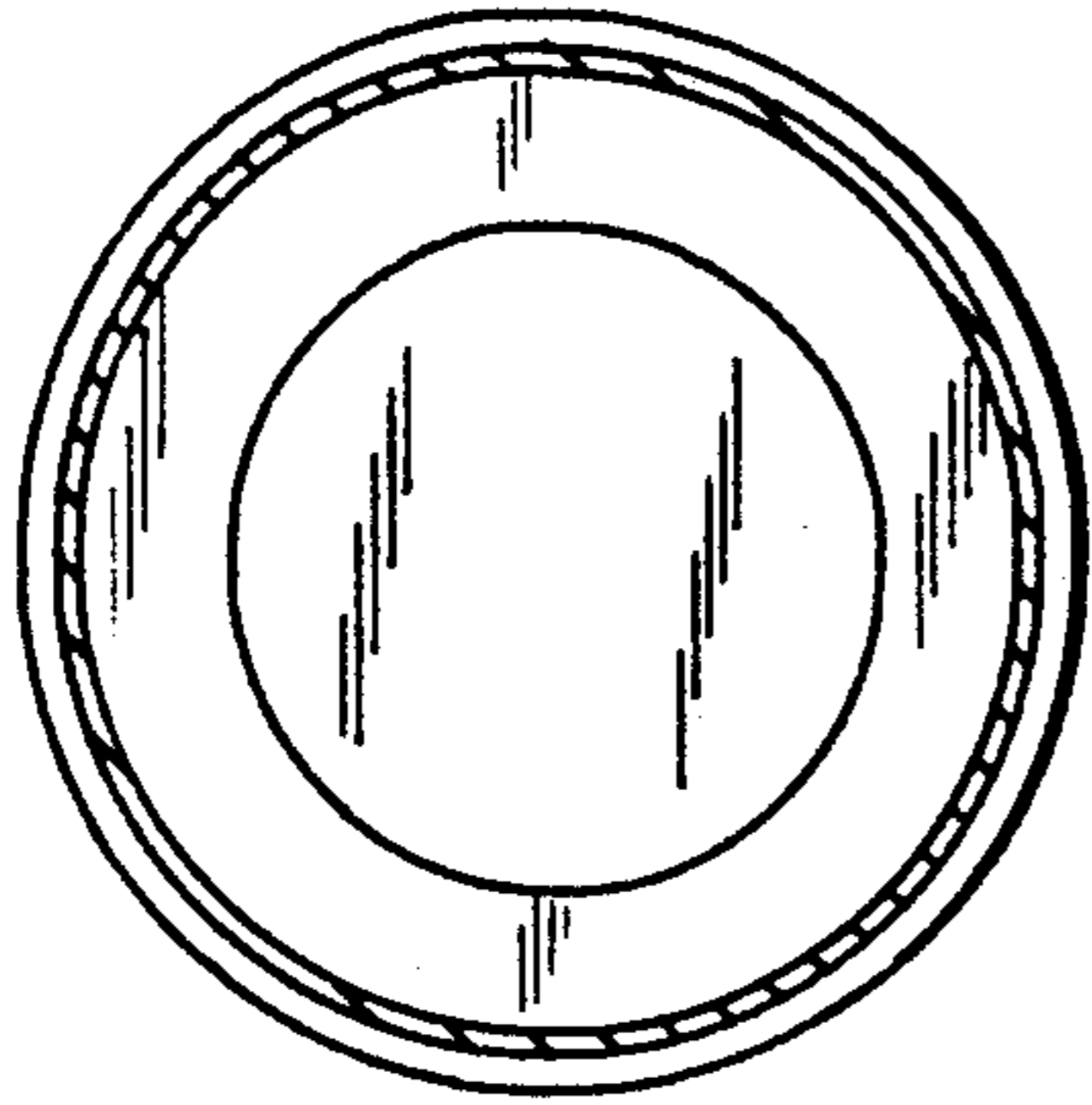

FIG. 5

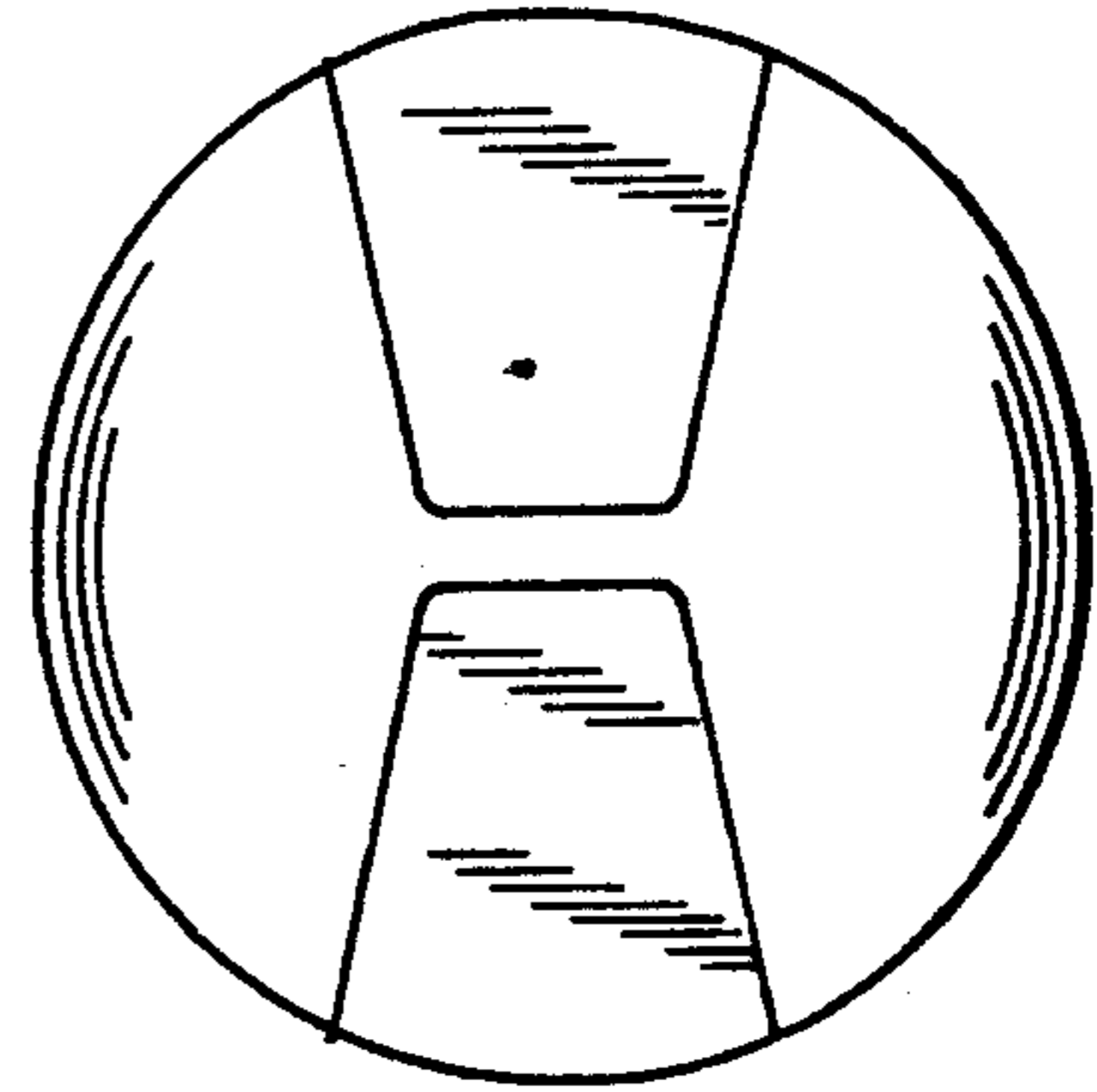

FIG. 1

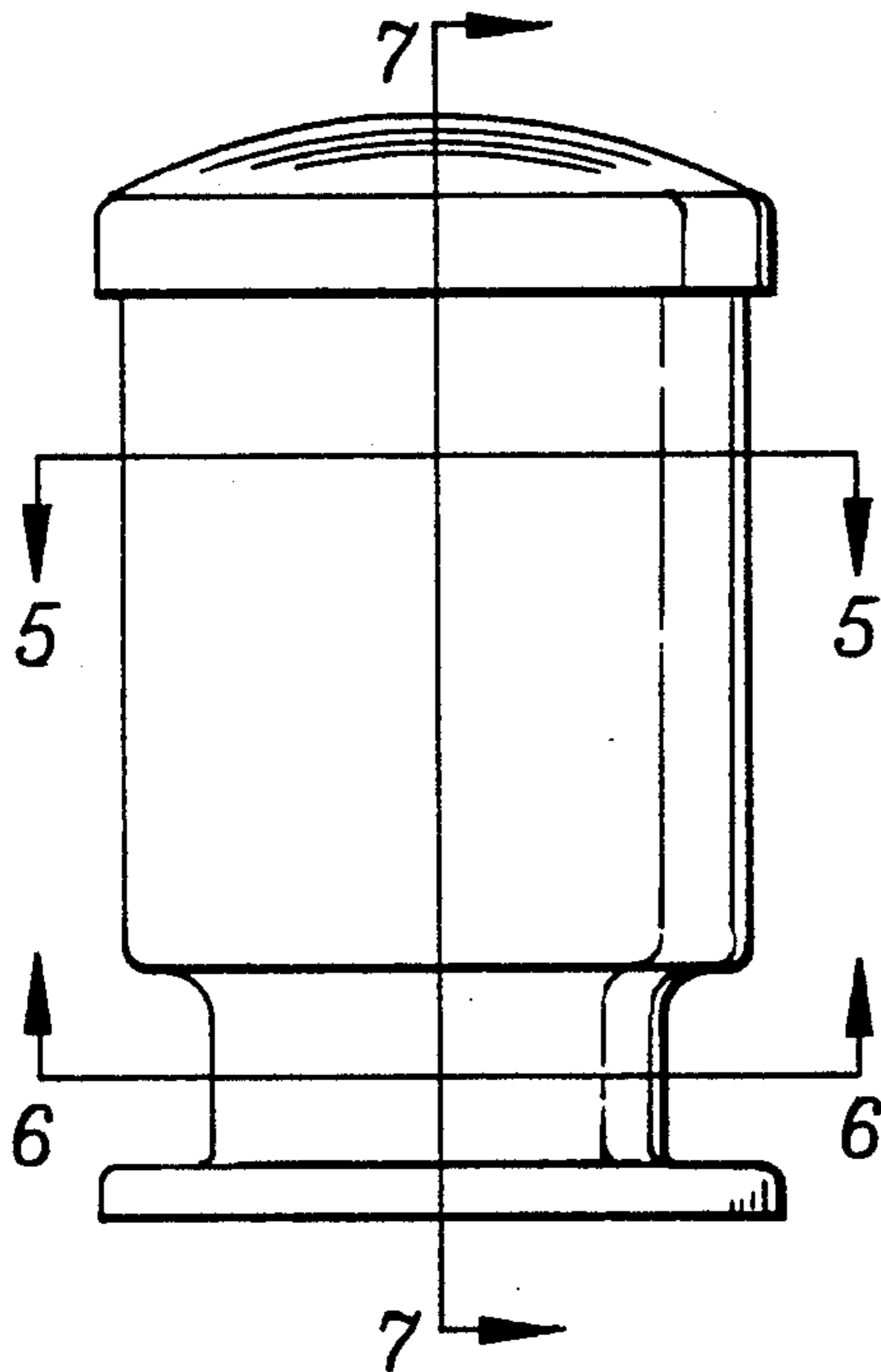

FIG. 4

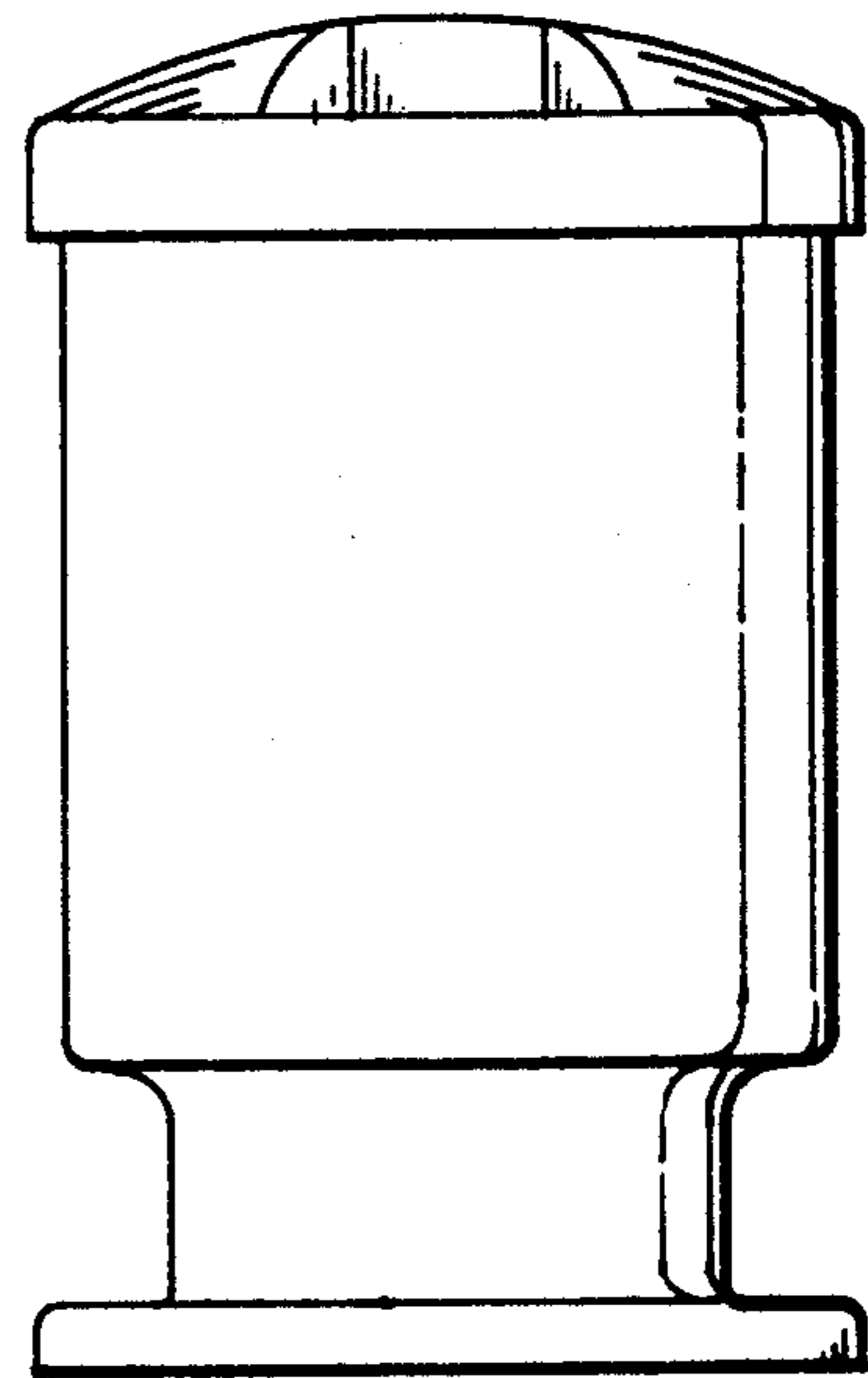

FIG. 2

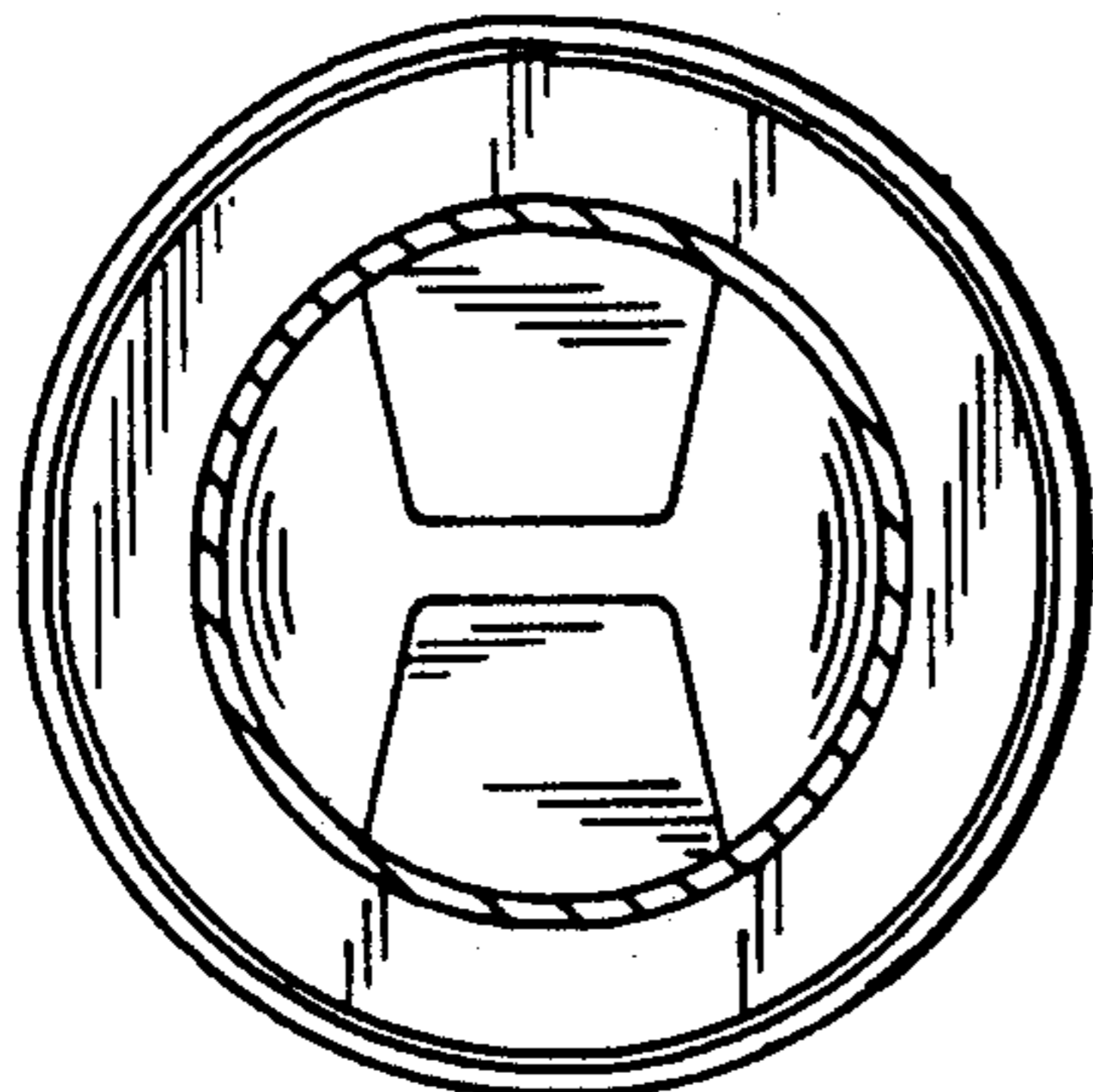

FIG. 6

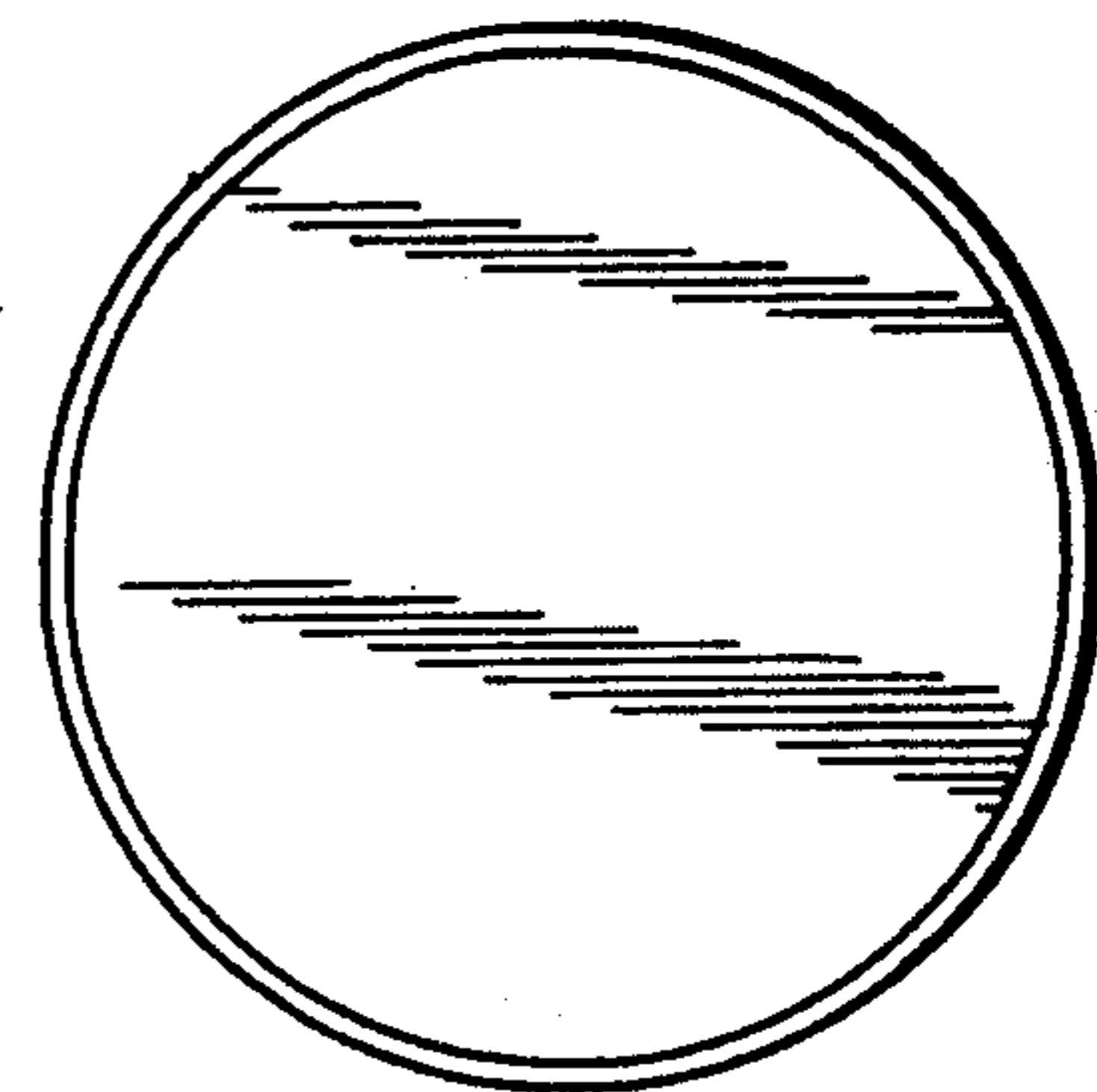

FIG. 3

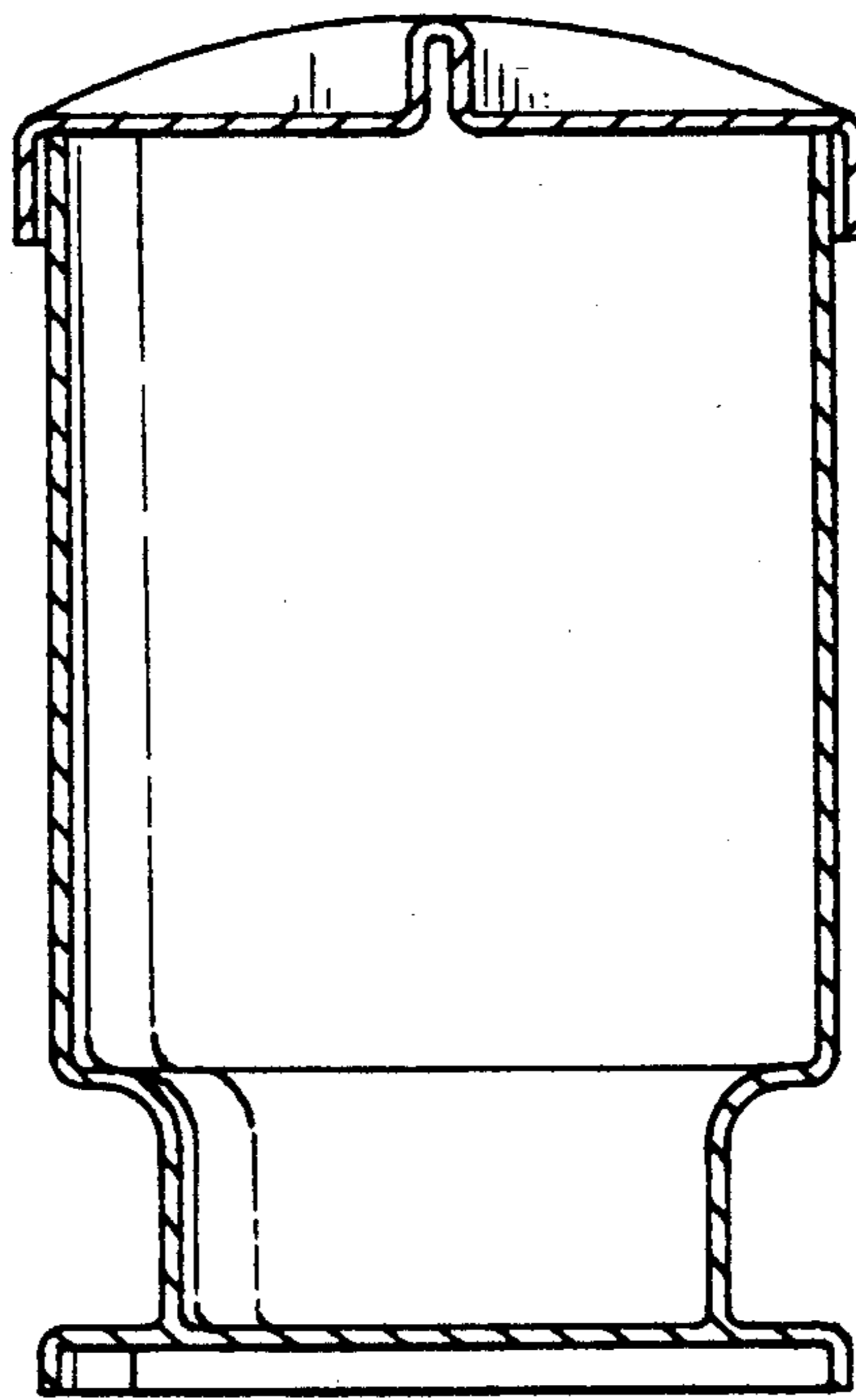

FIG. 7