



US00D338714S

United States Patent [19]

[11] Patent Number: **Des. 338,714**

Oliphant et al.

[45] Date of Patent: **** Aug. 24, 1993**

[54] **COMBINED LID AND FAN UNIT AND CUP THEREFOR**

3,808,825 5/1974 Ciurea D23/328

[75] Inventors: **Samuel C. Oliphant**, 13217 Green Valley Dr., Oklahoma City, Okla. 73120; **David E. Gormley**, Pocola, Okla.

[73] Assignee: **Samuel C. Oliphant**, Oklahoma City, Okla.

[**] Term: **14 Years**

[21] Appl. No.: **639,172**

[22] Filed: **Jan. 7, 1991**

[52] U.S. Cl. **D23/328; D23/370; D7/509; D7/511**

[58] Field of Search **D23/328, 352; 126/204; 62/3.62, 457.3; D7/510, 396.2, 511, 509, 317, 316, 312, 300, 300.1, 398, 397**

[56] **References Cited**

U.S. PATENT DOCUMENTS

3,235,116 2/1966 Leonard D7/317

OTHER PUBLICATIONS

Better Homes and Gardens, Apr., 1978, p. 104, Miracle Separator, top left side of page.

Stile Industria #32, May 1961, p. 5, lower illustration, Lids A, B and C.

HFD, Nov. 16, 1987, p. 132, Cupola A, middle of page.

Primary Examiner—Wallace R. Burke

Assistant Examiner—Lisa Lichtenstein

Attorney, Agent, or Firm—Dunlap, Codding & Lee

[57] **CLAIM**

The ornamental design for combined lid and fan unit and cup, therefor, as shown.

DESCRIPTION

FIG. 1 is a side elevational view of a combined lid and fan unit and cup therefor, showing our new design;

FIG. 2 is a front elevational view thereof;

FIG. 3 is a top plan view thereof;

FIG. 4 is a rear elevational view thereof;

FIG. 5 is a side elevational view thereof; and,

FIG. 6 is a bottom plan view thereof.

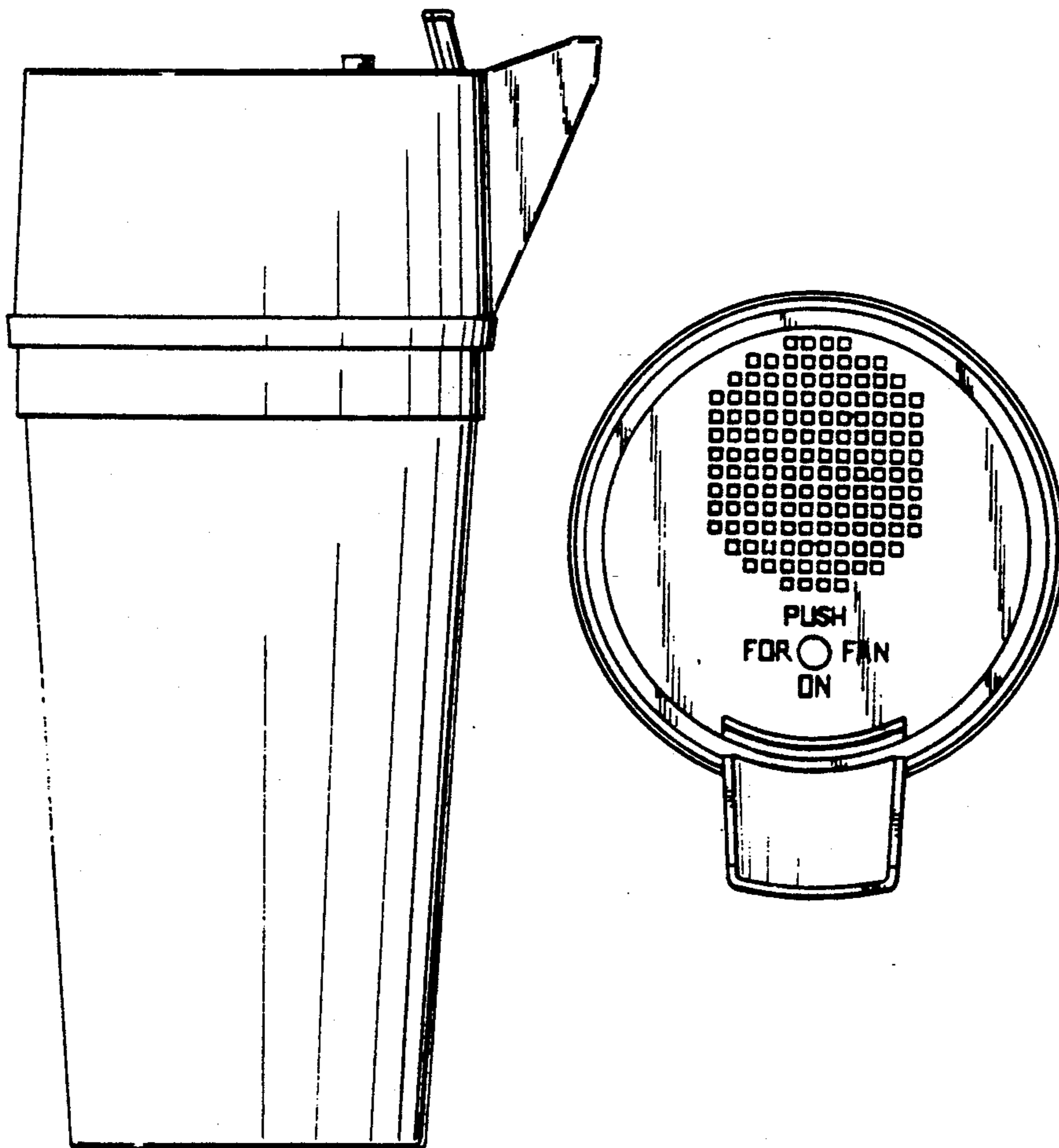

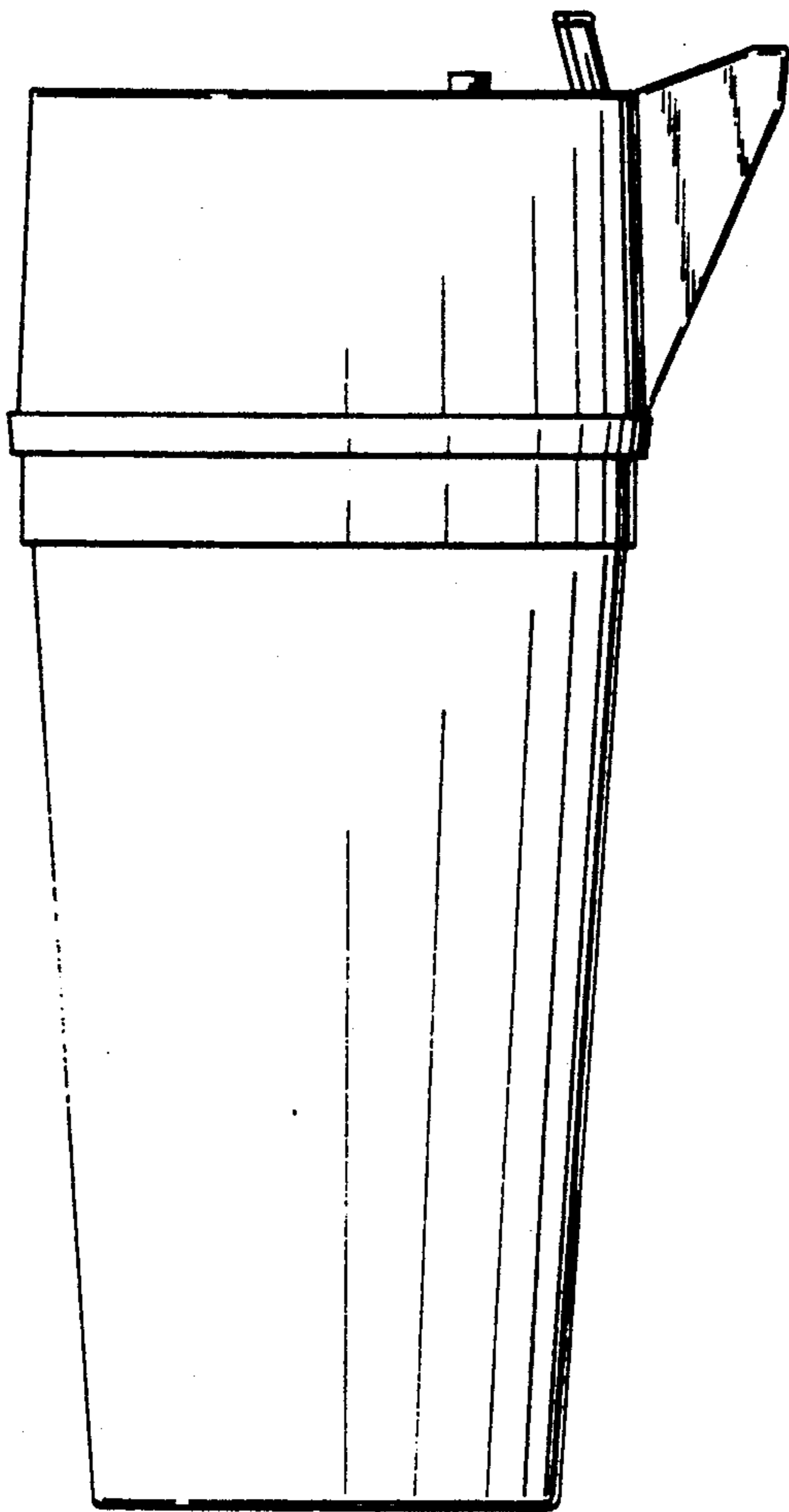

FIG. 1

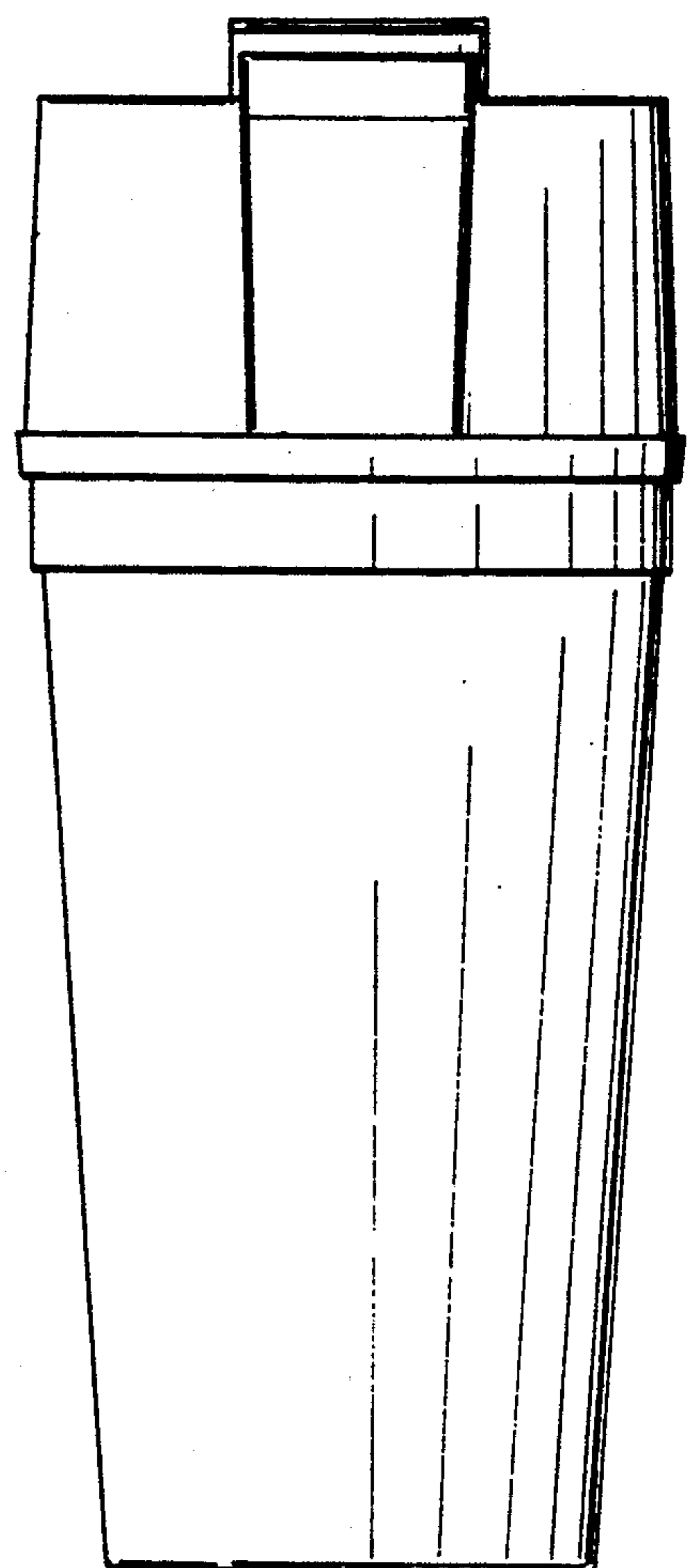

FIG. 2

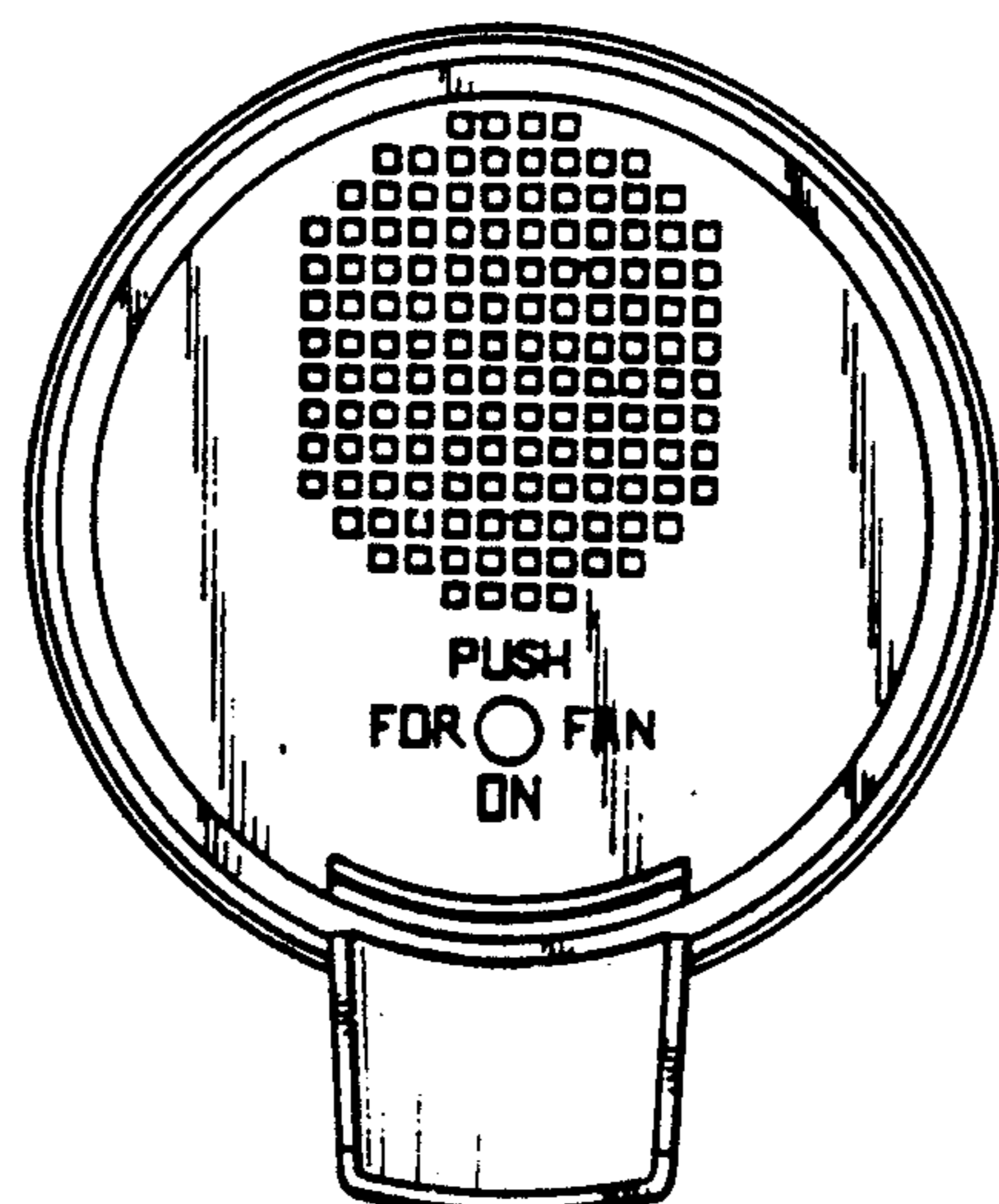

FIG. 3

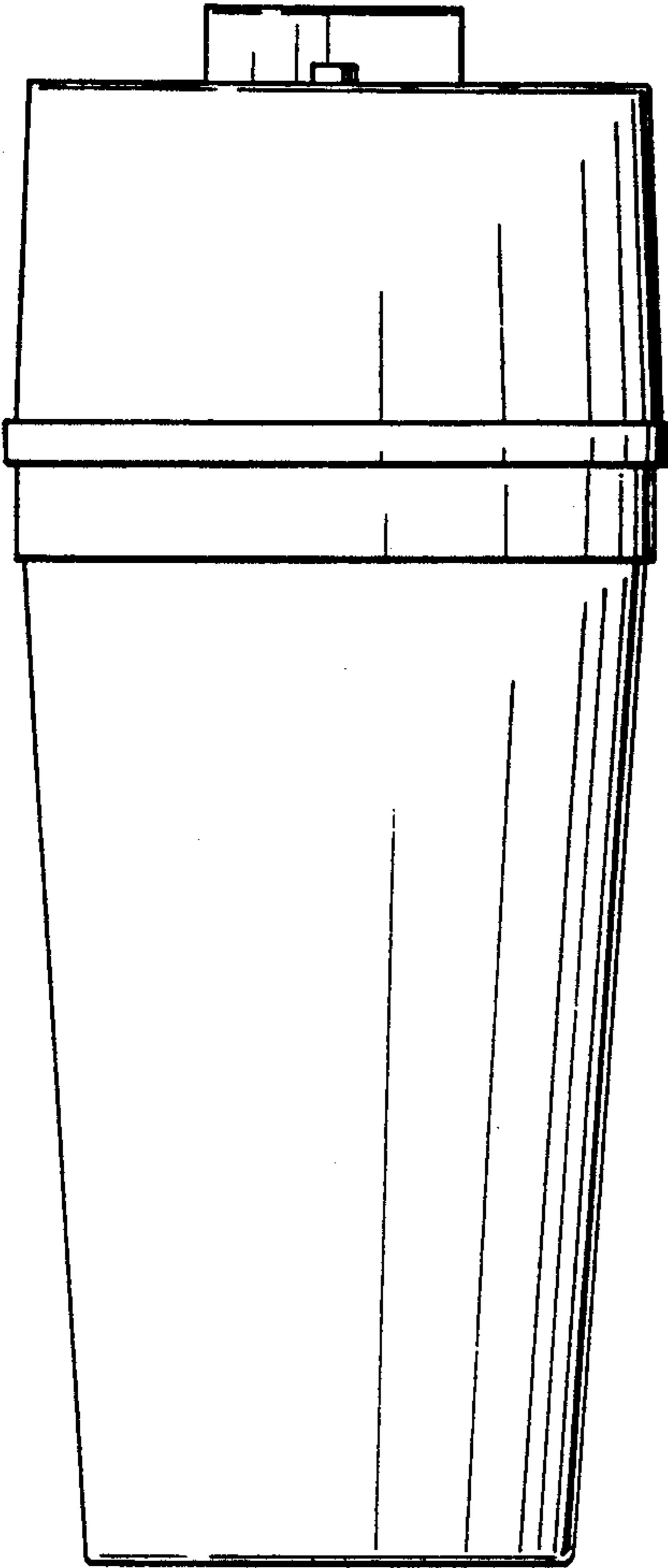

FIG. 4

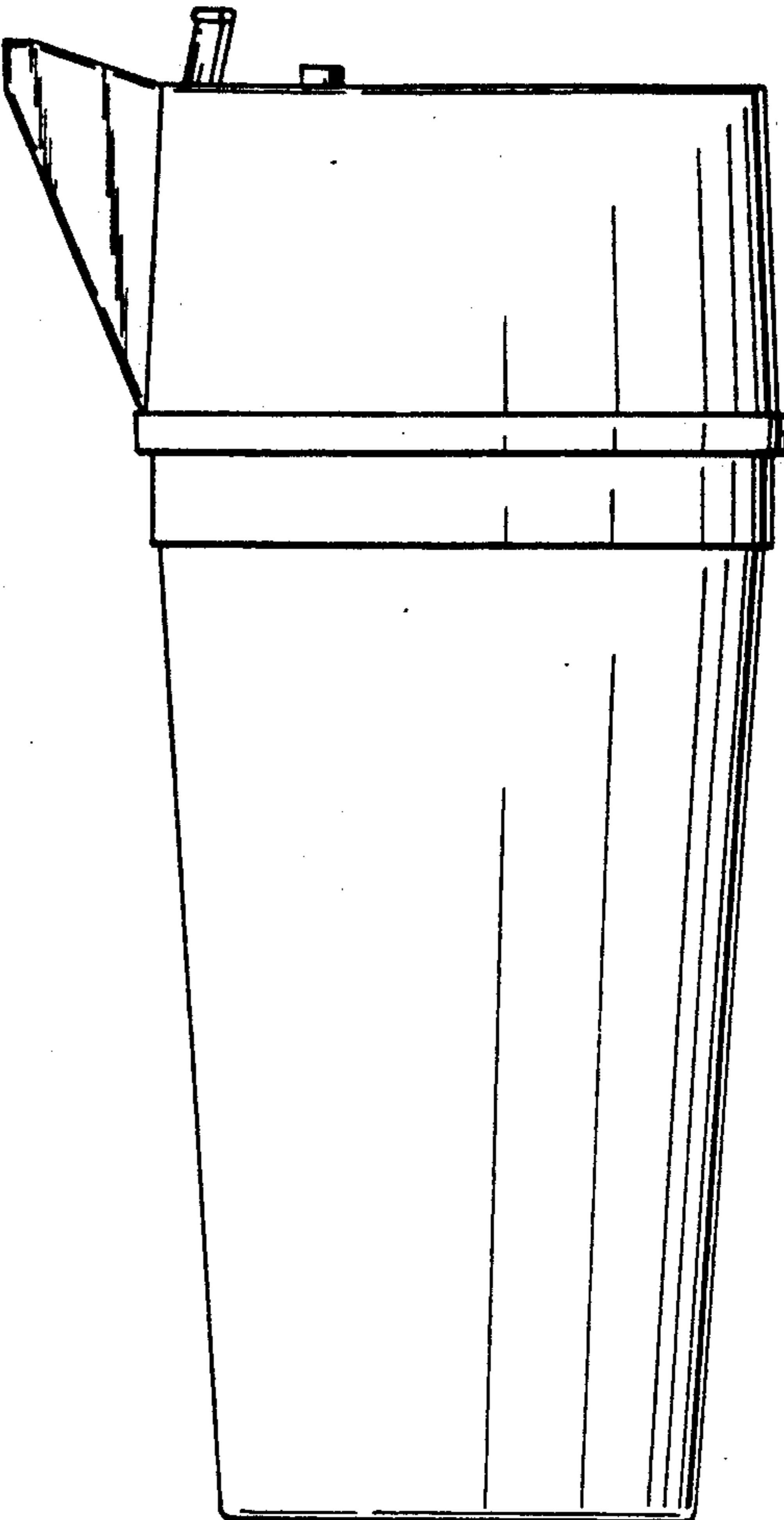

FIG. 5

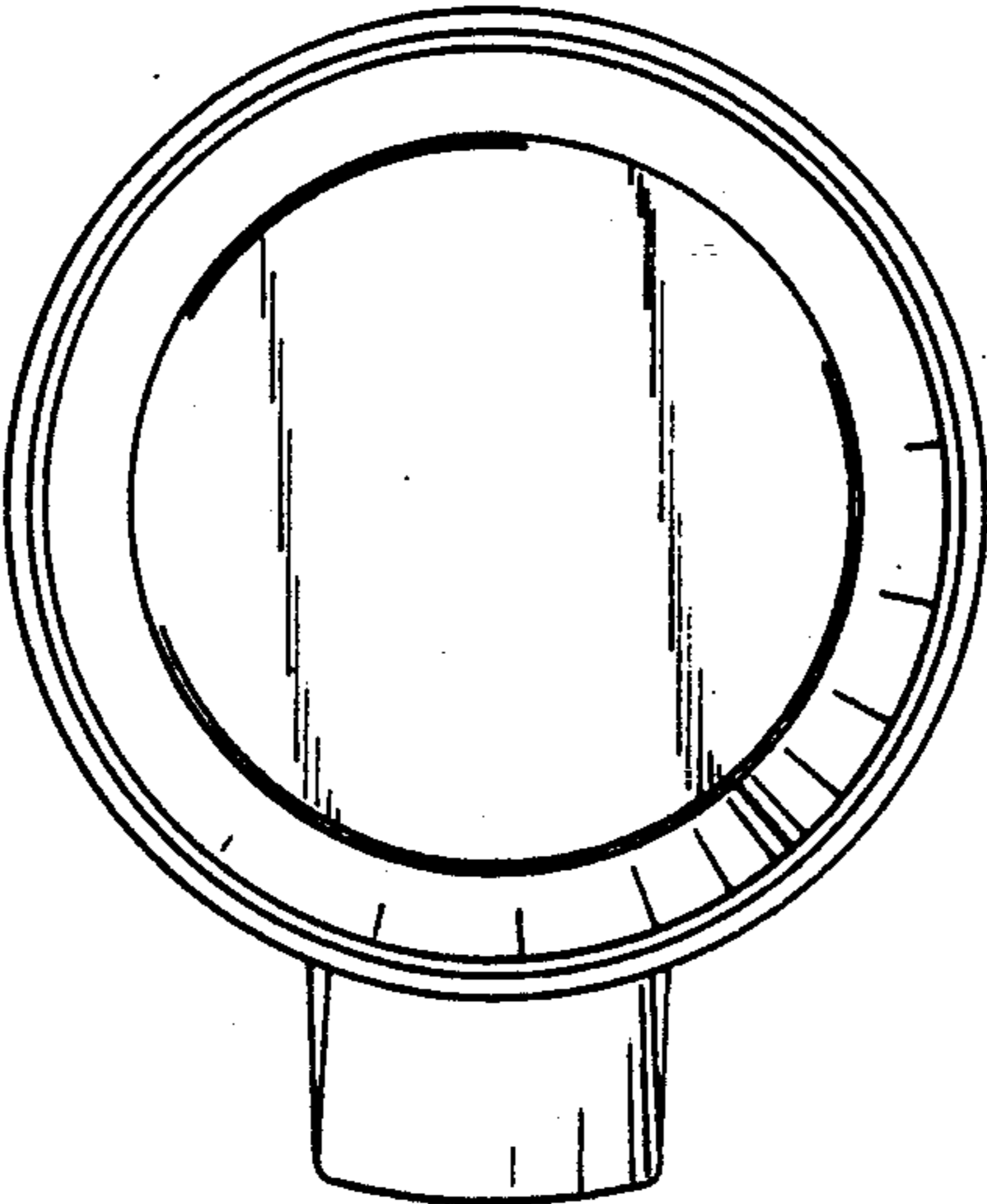

FIG. 6