



US00D338640S

United States Patent [19]

[11] Patent Number: **Des. 338,640**

Wilson

[45] Date of Patent: **** Aug. 24, 1993**

[54] **AUTOMOBILE**

[75] Inventor: **Douglas G. Wilson, Carlsbad, Calif.**

[73] Assignee: **Nissan Motor Co., Ltd., Yokohama, Japan**

[**] Term: **14 Years**

[21] Appl. No.: **669,748**

[22] Filed: **Mar. 14, 1991**

[52] U.S. Cl. **D12/92**

[58] Field of Search **D12/92; 296/185**

[56] **References Cited**

PUBLICATIONS

Motor Trend, Nov. 1989, p. 24, Pontiac Bonneville Automobile, center of page.

Road & Track, Oct. 1990, p. 107, Infiniti G20 Automobile, bottom of page.

Car & Driver, May 1990, p. 31, Acura Legend Automobile, top of page.

Motor Trend, Jun. 1985, p. 44, Taillights of Camaro GT2, bottom of page.

*Primary Examiner—James M. Gandy
Attorney, Agent, or Firm—Foley & Lardner*

[57] **CLAIM**

The ornamental design for an automobile, as shown.

DESCRIPTION

FIG. 1 is a front perspective view of an automobile showing the new design;

FIG. 2 is a rear perspective view thereof;

FIG. 3 is a front elevation view thereof;

FIG. 4 is a rear elevation view thereof;

FIG. 5 is a left side elevation view thereof;

FIG. 6 is a right side elevation view thereof;

FIG. 7 is a top plan view thereof; and,

FIG. 8 is a bottom plan view thereof.

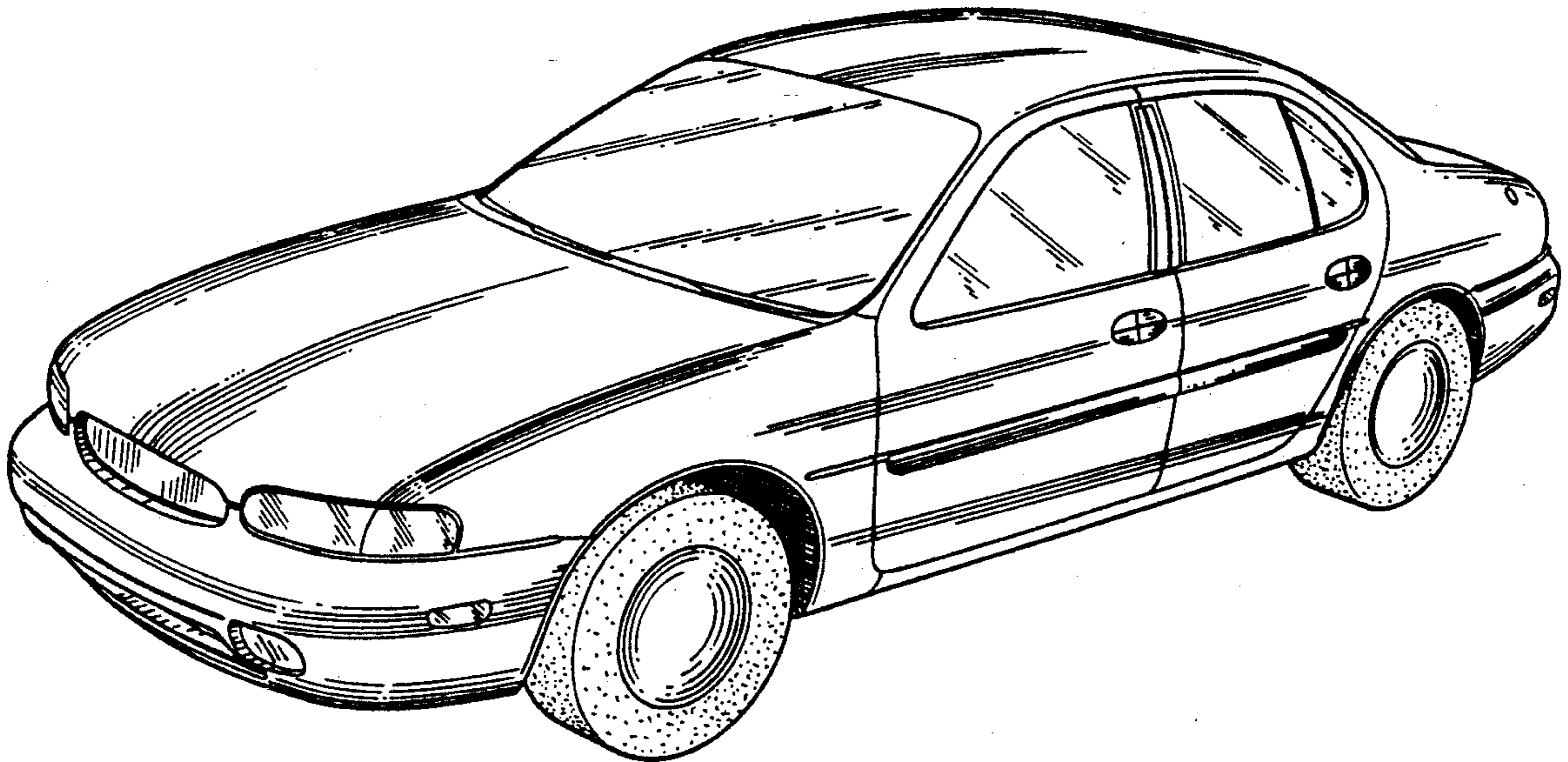

FIG. 1

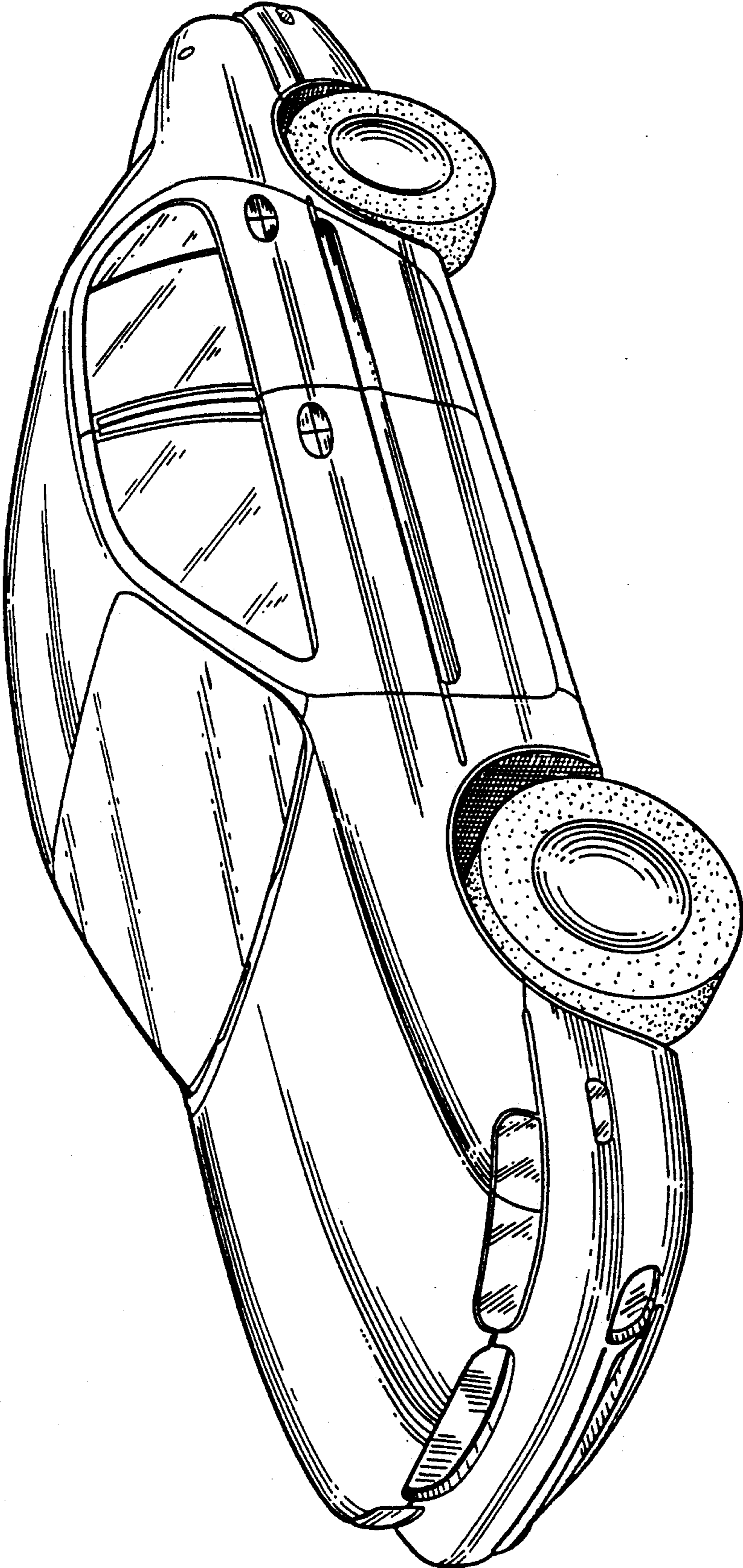

FIG. 2

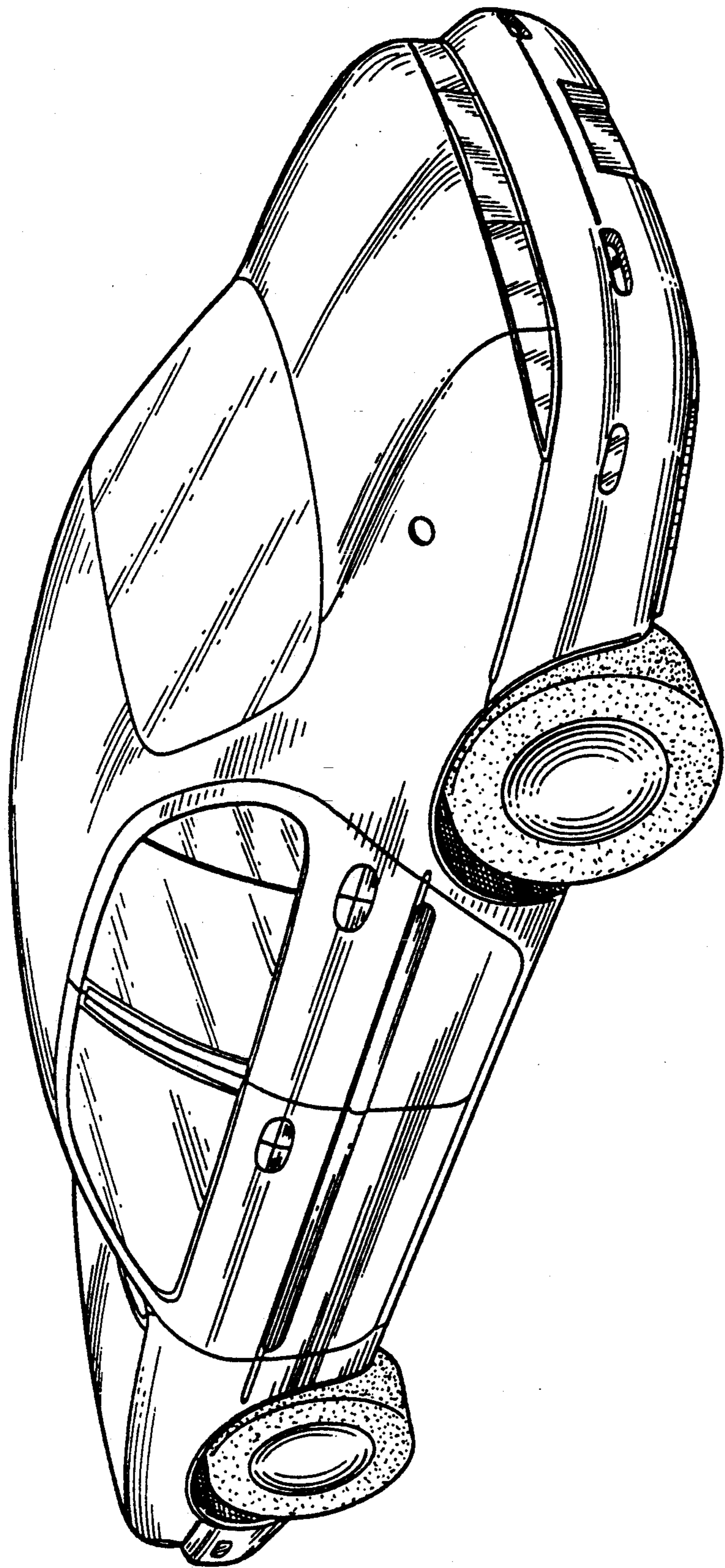

FIG. 4

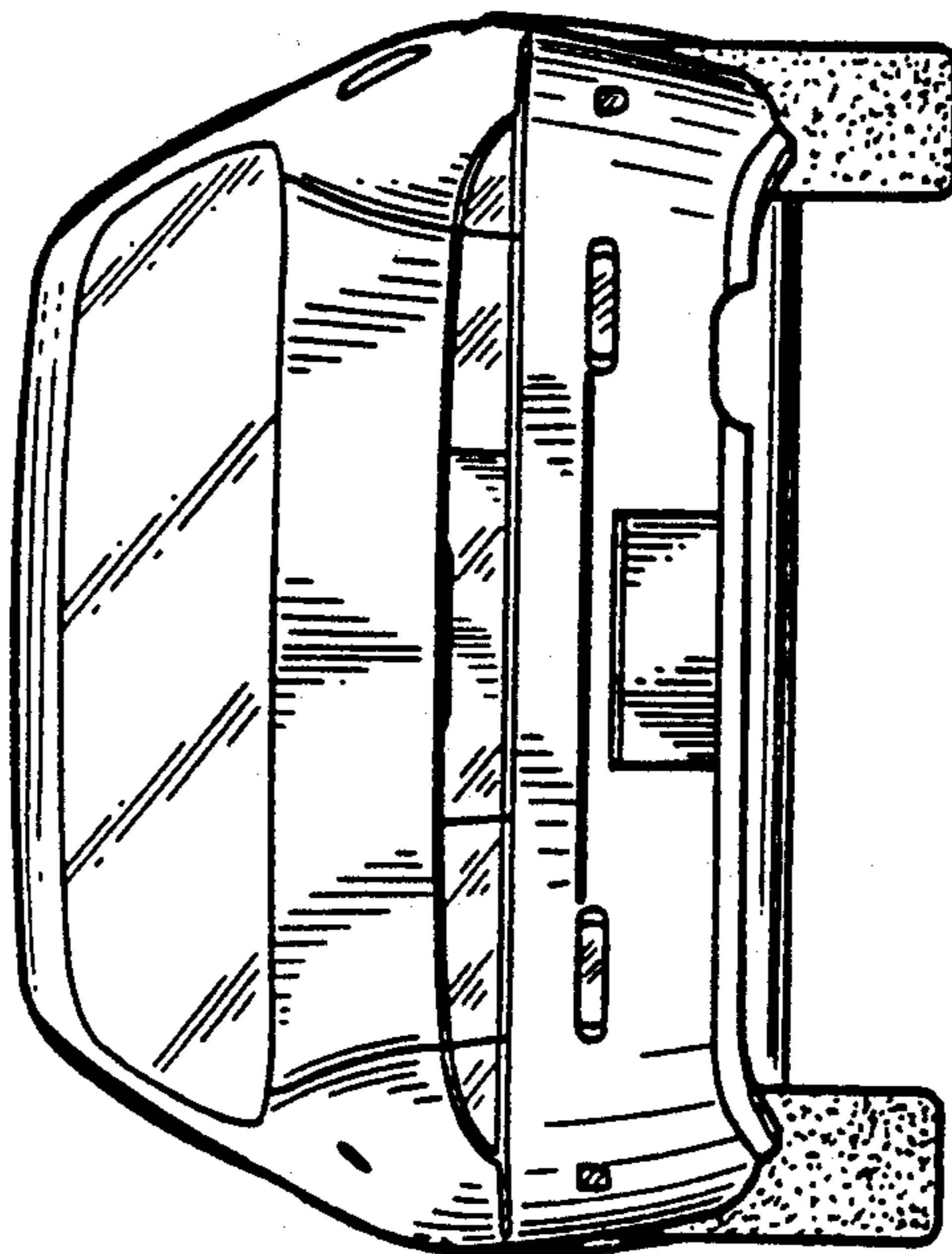

FIG. 3

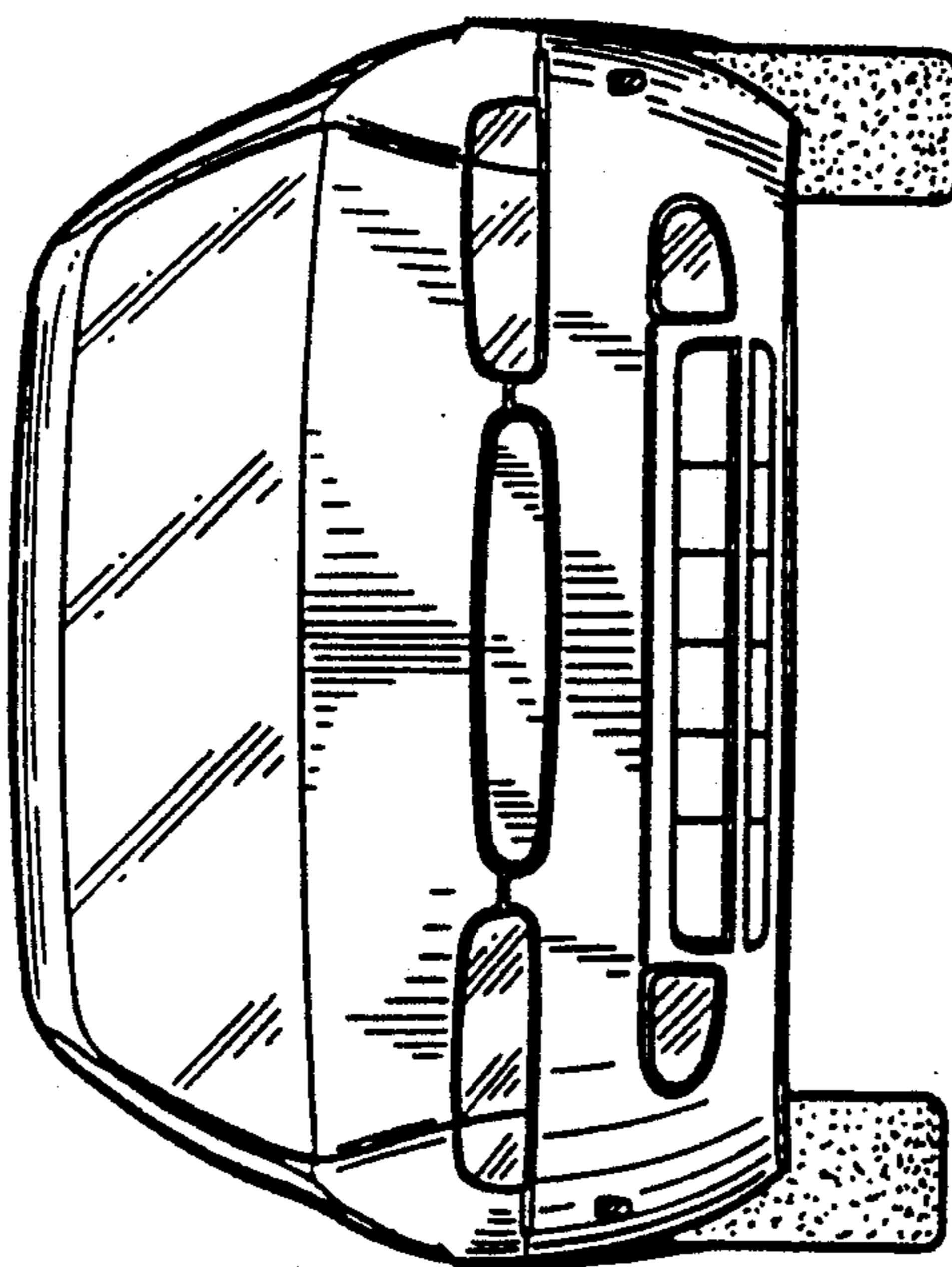

FIG. 5

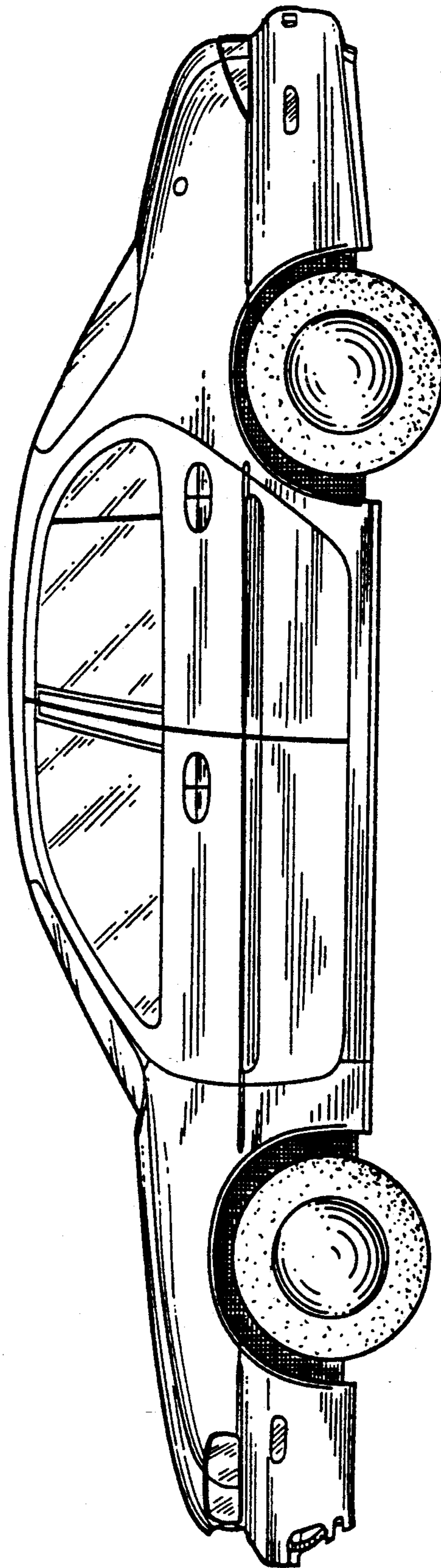

FIG. 6

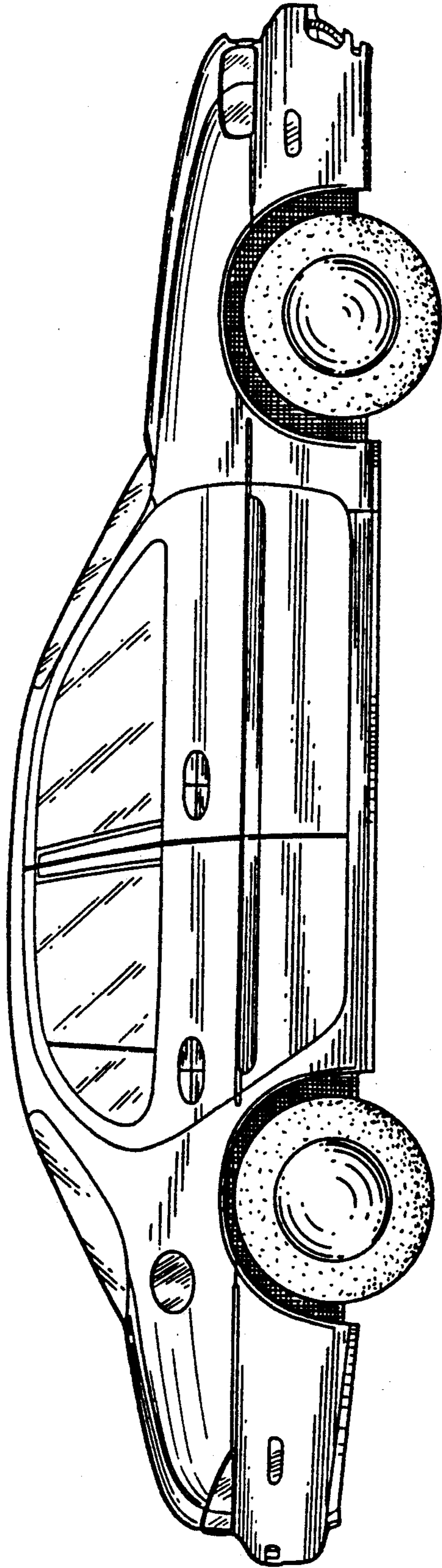

FIG. 7

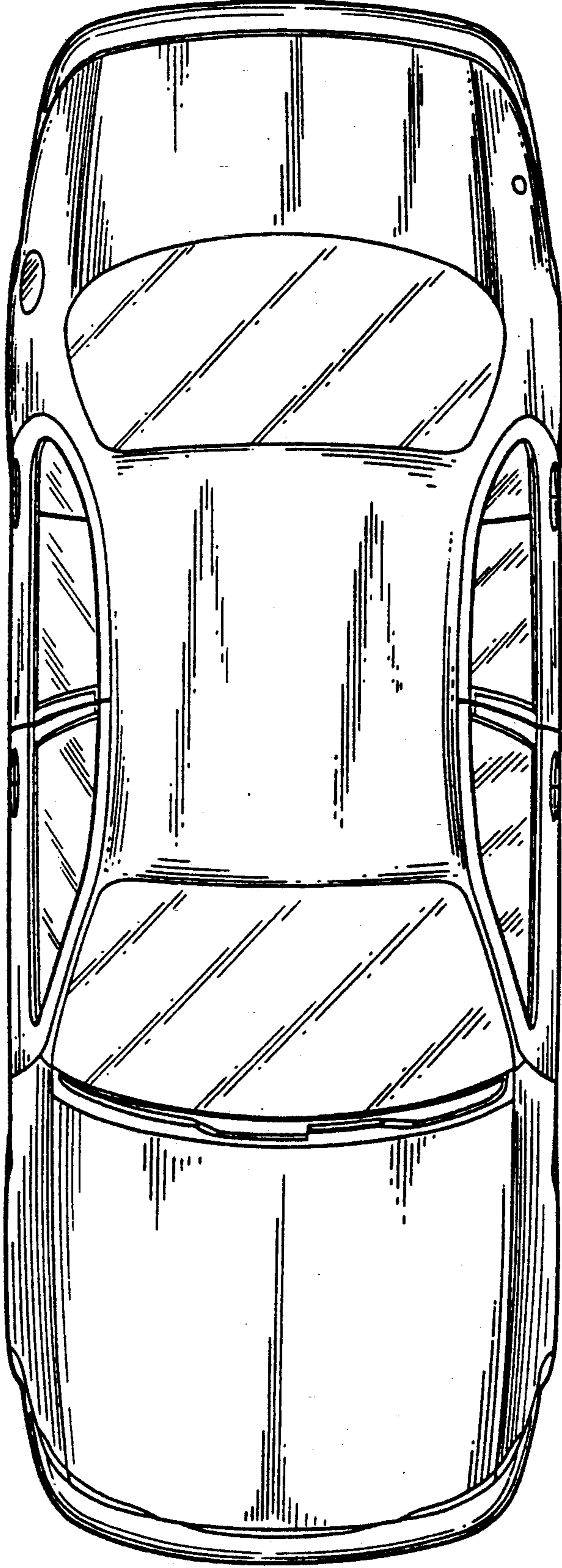

FIG. 8

