



US00D338522S

# United States Patent [19]

[11] Patent Number: **Des. 338,522**

**Muderlak**

[45] Date of Patent: **\*\* Aug. 17, 1993**

## [54] FRAGRANCE DISPENSER HOUSING

[75] Inventor: **Kenneth J. Muderlak**, Shorewood, Wis.

[73] Assignee: **Technical Concepts, L.P.**, Elk Grove Village, Ill.

[\*\*] Term: **14 Years**

[21] Appl. No.: **831,037**

[22] Filed: **Feb. 4, 1992**

[52] U.S. Cl. .... **D23/366**

[58] Field of Search ..... **D23/366; 239/51.5, 55, 239/56, 57, 58, 59; 392/390, 392; 261/DIG. 65; 422/305**

### [56] References Cited

#### U.S. PATENT DOCUMENTS

|            |        |                |         |
|------------|--------|----------------|---------|
| D. 211,962 | 8/1968 | Soles .....    | D23/366 |
| D. 273,225 | 3/1984 | Palson .....   | D23/366 |
| D. 323,883 | 2/1992 | Caporale ..... | D23/366 |

## OTHER PUBLICATIONS

Neutralle-Aero I-Environmental Fan Cabinet, Sales Brochure (2 pgs.), 1990.

Neutralle-Mach II Environmental Fan Cabinet, Sales Brochure (2 pgs.), 1990.

Neutralle-Pulse I Automatic Aerosol Dispenser System, Sales Brochure (4 pgs.), 1990.

*Primary Examiner*—Wallace R. Burke

*Assistant Examiner*—Lisa Lichtenstein

*Attorney, Agent, or Firm*—Welsh & Katz, Ltd.

## [57] CLAIM

The ornamental design for a fragrance dispenser housing, as shown.

## DESCRIPTION

FIG. 1 is a front, top, and left side perspective view of a fragrance dispenser housing showing my new design; FIG. 2 is a front elevational view thereof; FIG. 3 is a left side elevation view thereof; FIG. 4 is a right side elevational view thereof; FIG. 5 is a rear elevational view thereof; FIG. 6 is a top plan view thereof; and, FIG. 7 is a bottom plan view thereof.

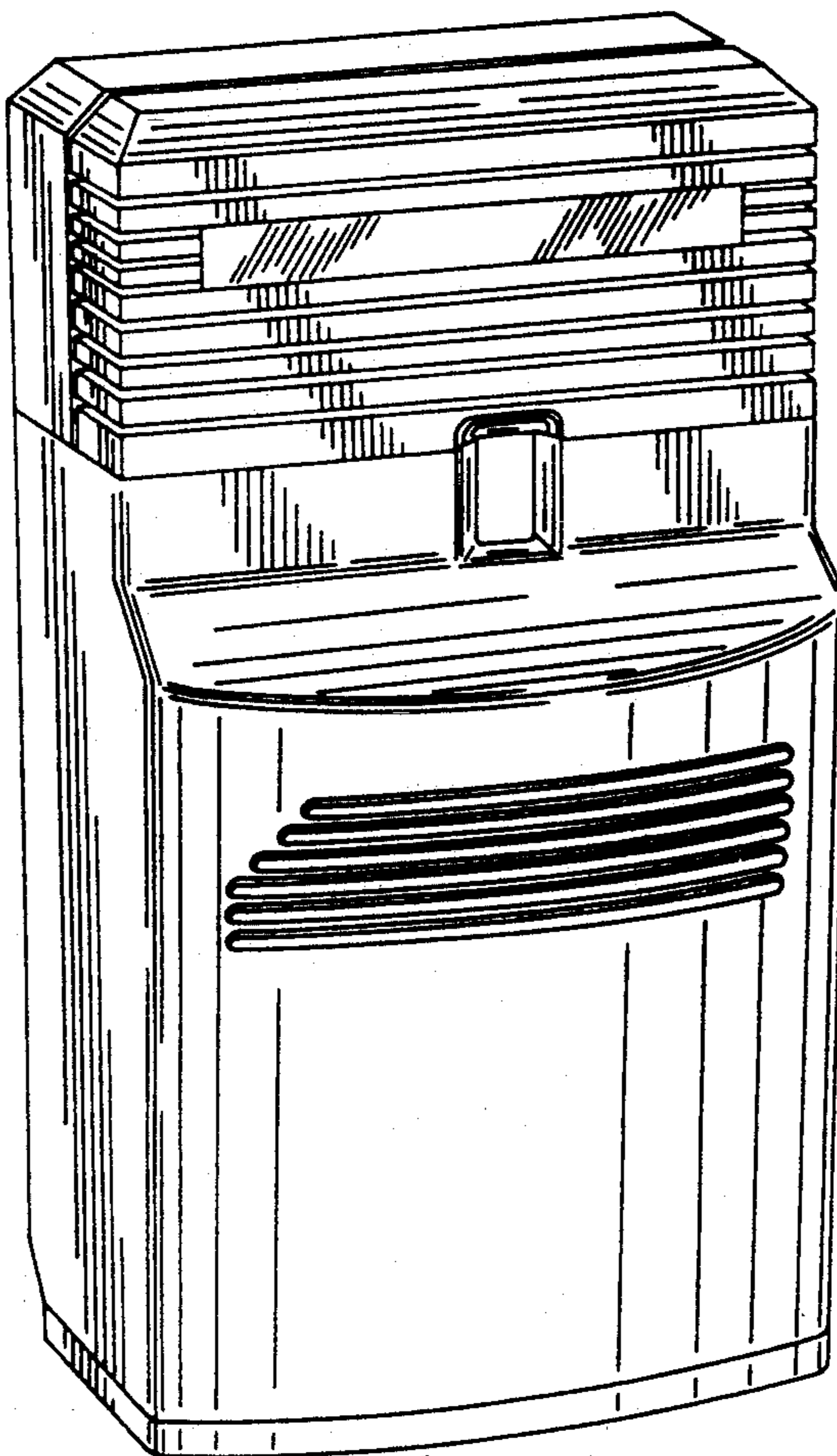

FIG. 2

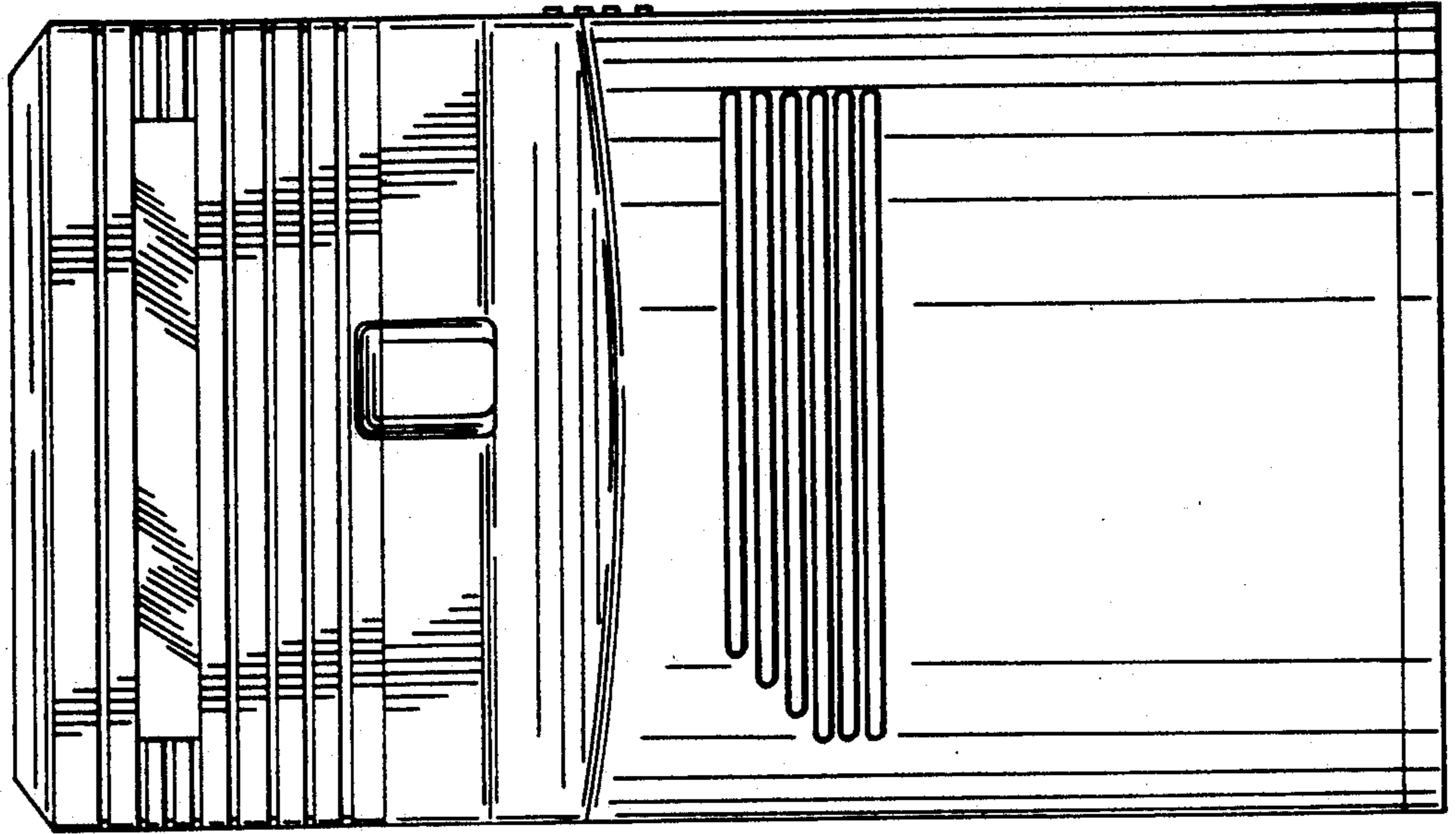

FIG. 1

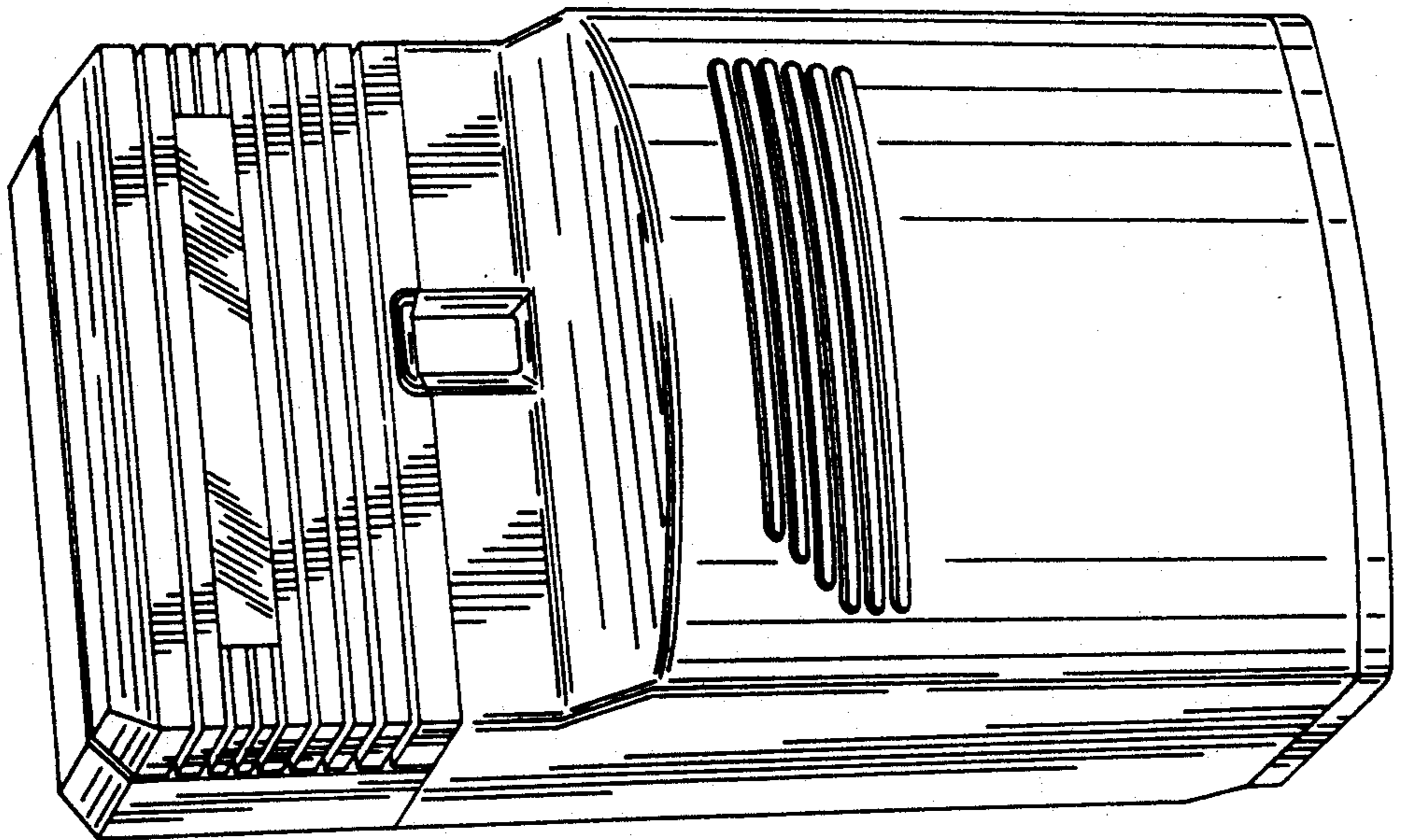

FIG.4

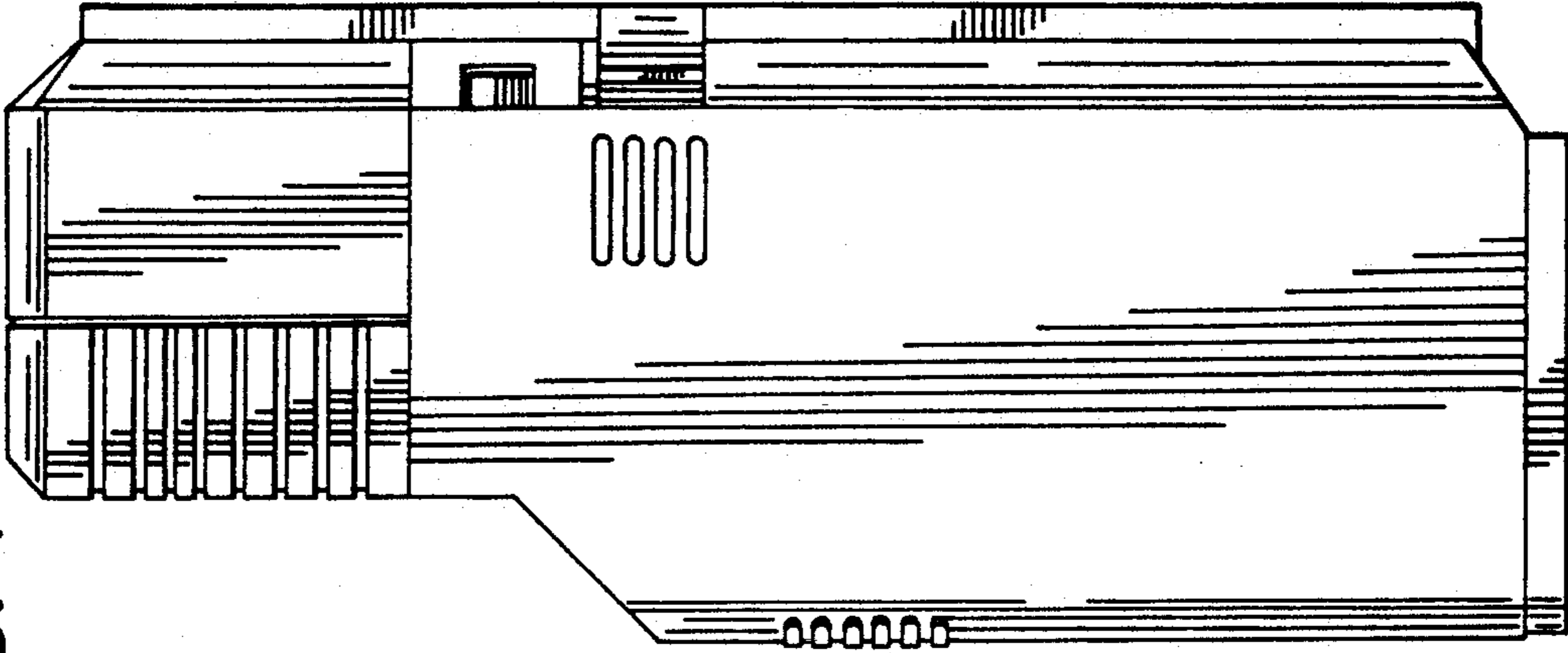

FIG.3

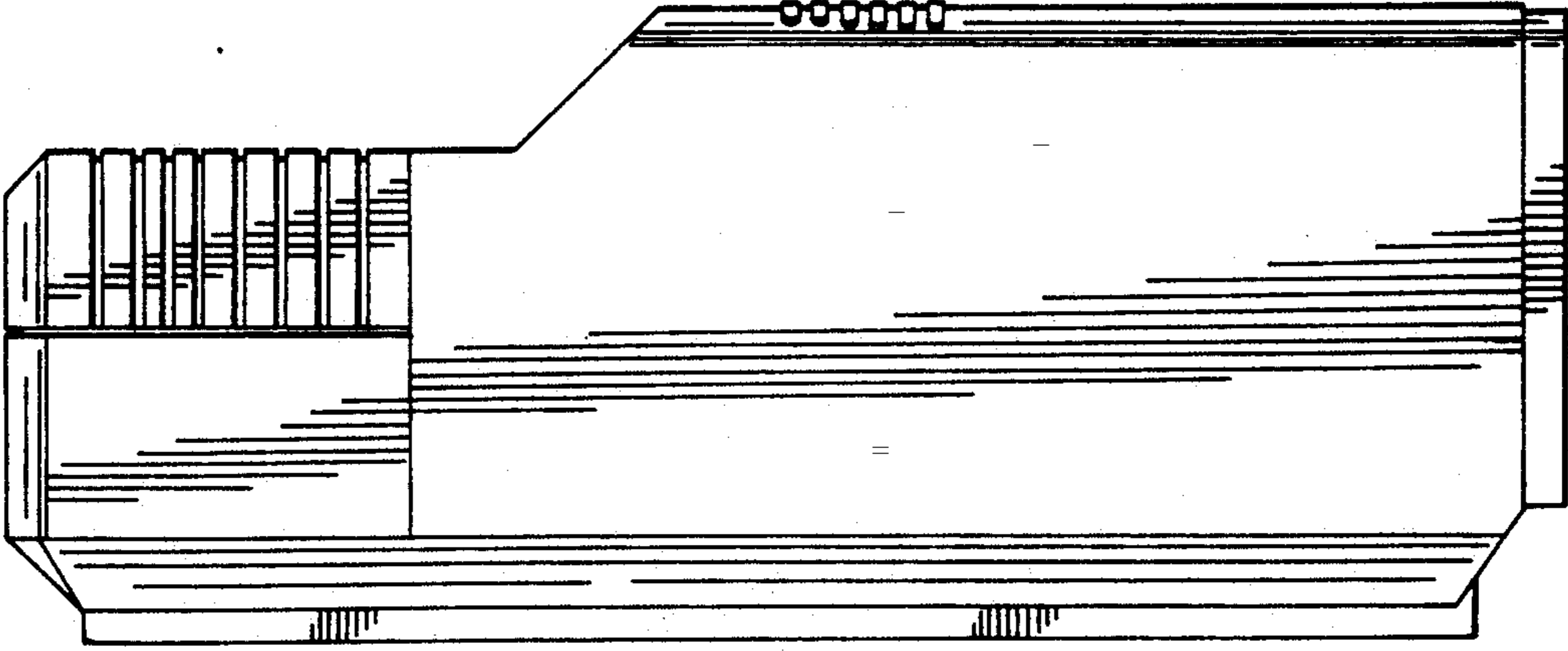

FIG. 6

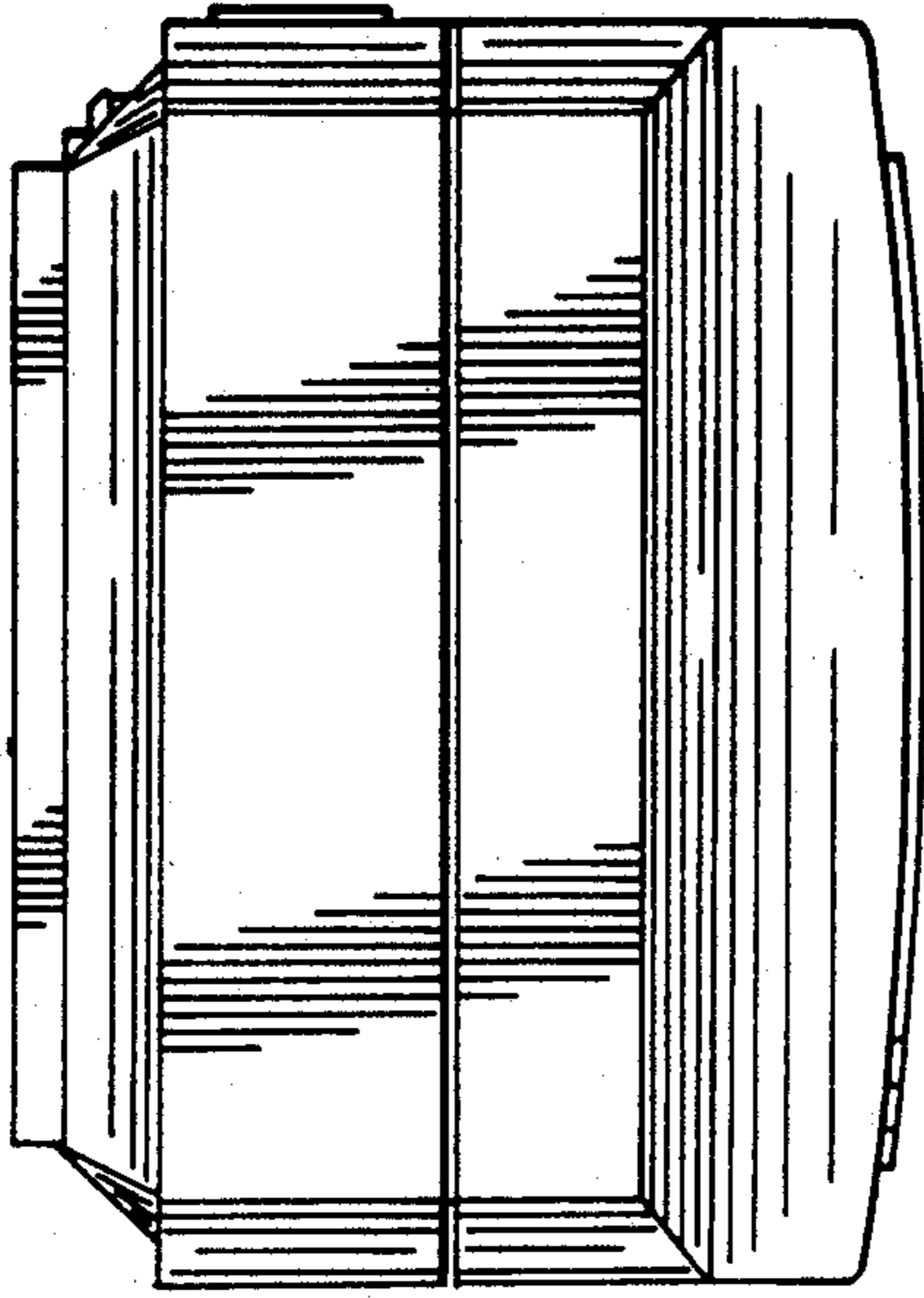

FIG. 7

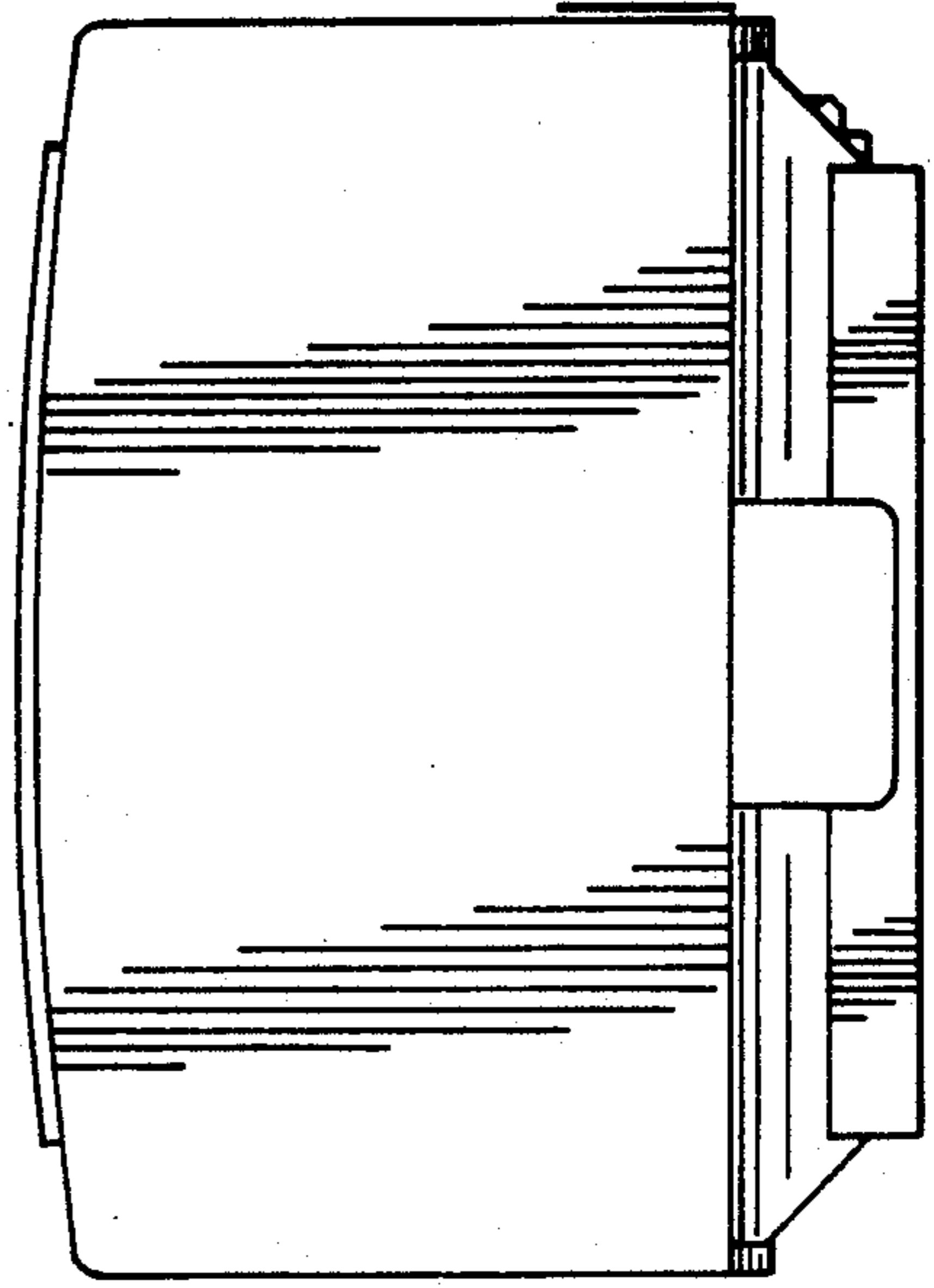

FIG. 5

