



US00D338509S

# United States Patent [19]

[11] Patent Number: **Des. 338,509**

Gustafsson

[45] Date of Patent: **\*\* Aug. 17, 1993**

[54] **EXERCISE BICYCLE**

D. 311,047 10/1990 Carnielli ..... D21/194

[75] Inventor: **Tore Gustafsson, Varberg, Sweden**

*Primary Examiner*—Bernard Ansher

*Assistant Examiner*—Philip Hyder

[73] Assignee: **Monark AB, Sweden**

*Attorney, Agent, or Firm*—Laff, Whitesel, Conte & Saret

[\*\*] Term: **14 Years**

### [57] CLAIM

[21] Appl. No.: **657,548**

The ornamental design for an exercise bicycle, as shown.

[22] Filed: **Feb. 19, 1991**

### DESCRIPTION

[52] U.S. Cl. .... **D21/194**

FIG. 1 is a front elevation of the exercise bicycle;

FIG. 2 is a rear elevation of the exercise bicycle;

[58] Field of Search ..... **D21/191, 194; 482/57,**

FIG. 3 is a top plan view of the exercise bicycle;

**482/58, 59**

FIG. 4 is a bottom plan view of the exercise bicycle;

FIG. 5 is a right side elevation of the exercise bicycle;

FIG. 6 is a left side elevation of the exercise bicycle;

FIG. 7 is a three-quarter perspective view taken from the front right of the exercise bicycle; and,

FIG. 8 is a three-quarter perspective view taken from the left rear of the exercise bicycle.

[56]

### References Cited

#### U.S. PATENT DOCUMENTS

- D. 290,149 6/1987 Nakao et al. .... D21/194
- D. 299,371 1/1989 Tsuyama ..... D21/194
- D. 299,732 2/1989 Gustafsson ..... D21/194
- D. 309,337 7/1990 Yang ..... D21/194

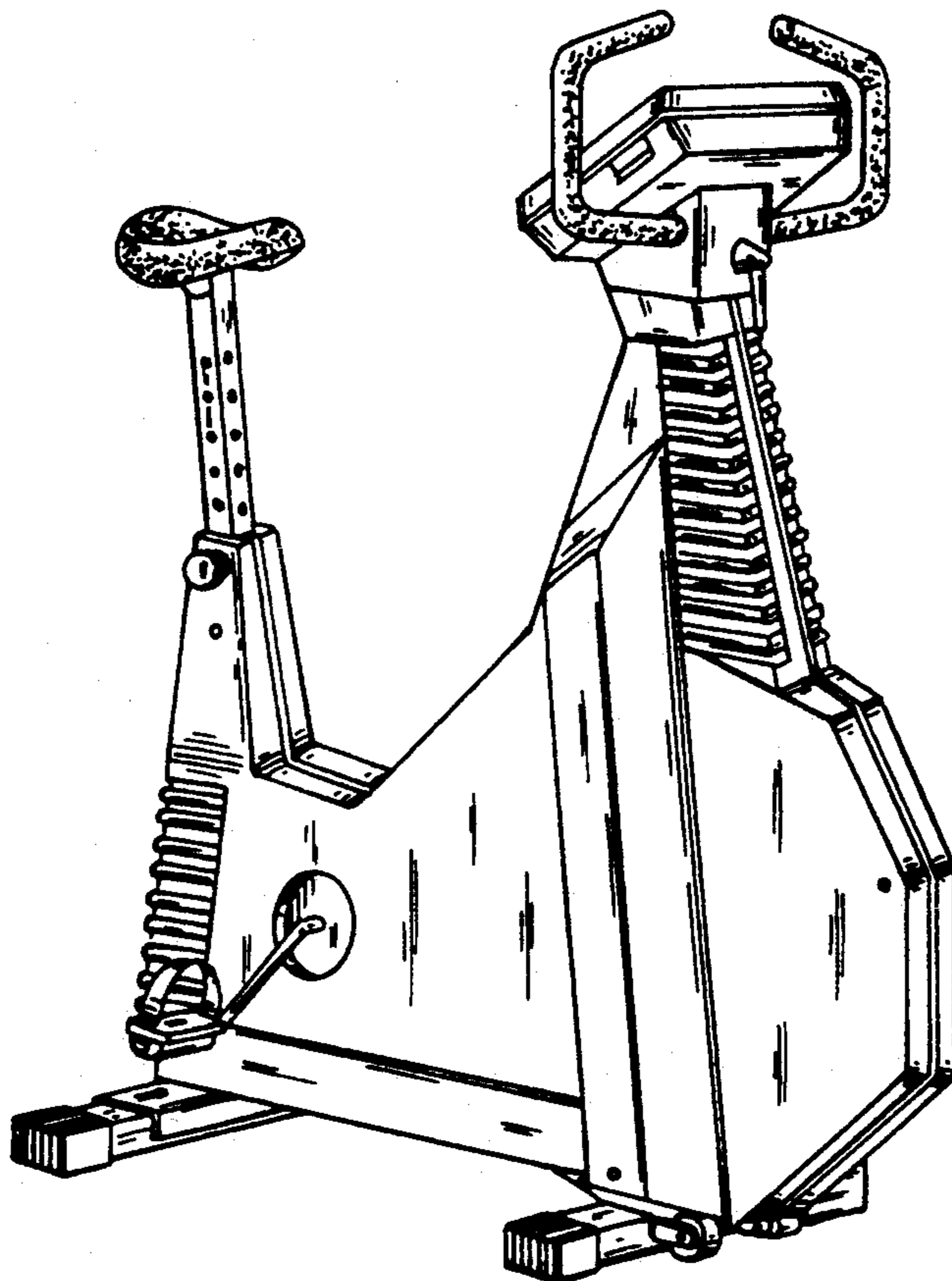

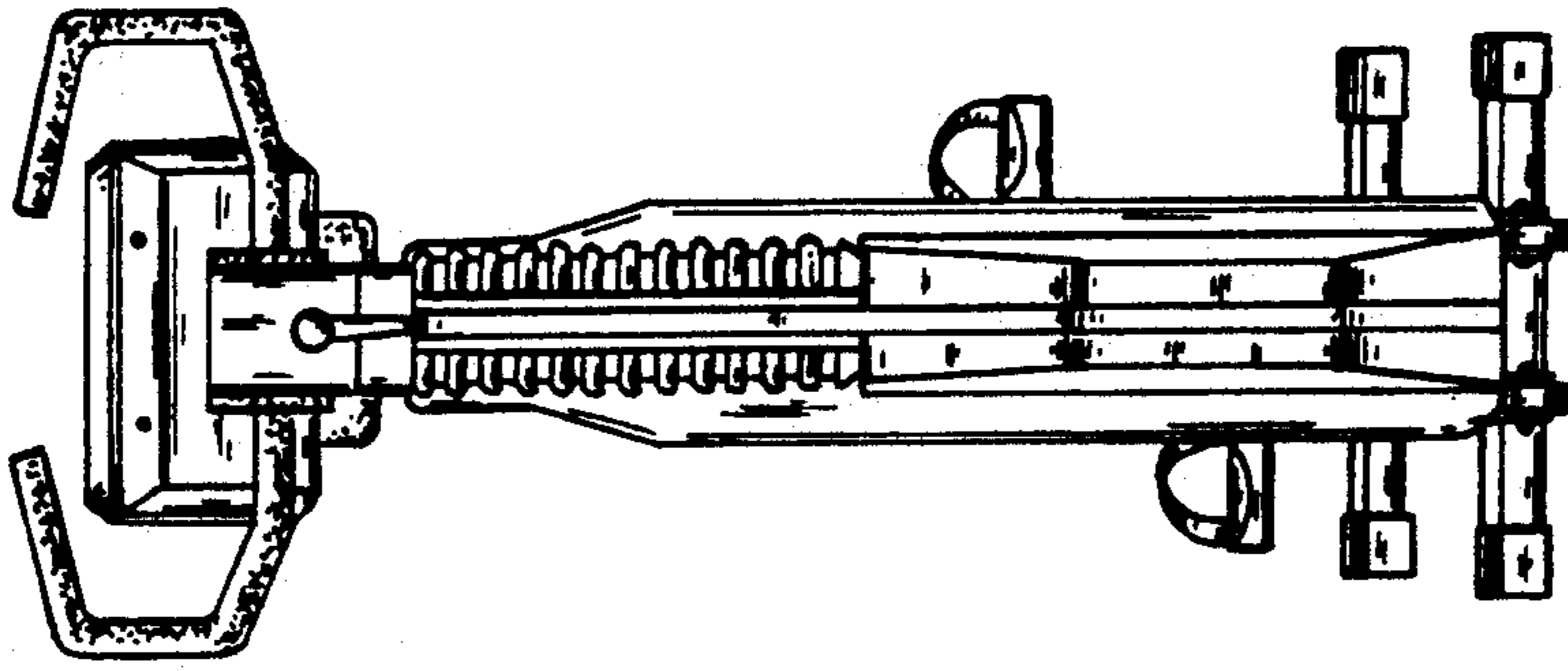

FIG. 2

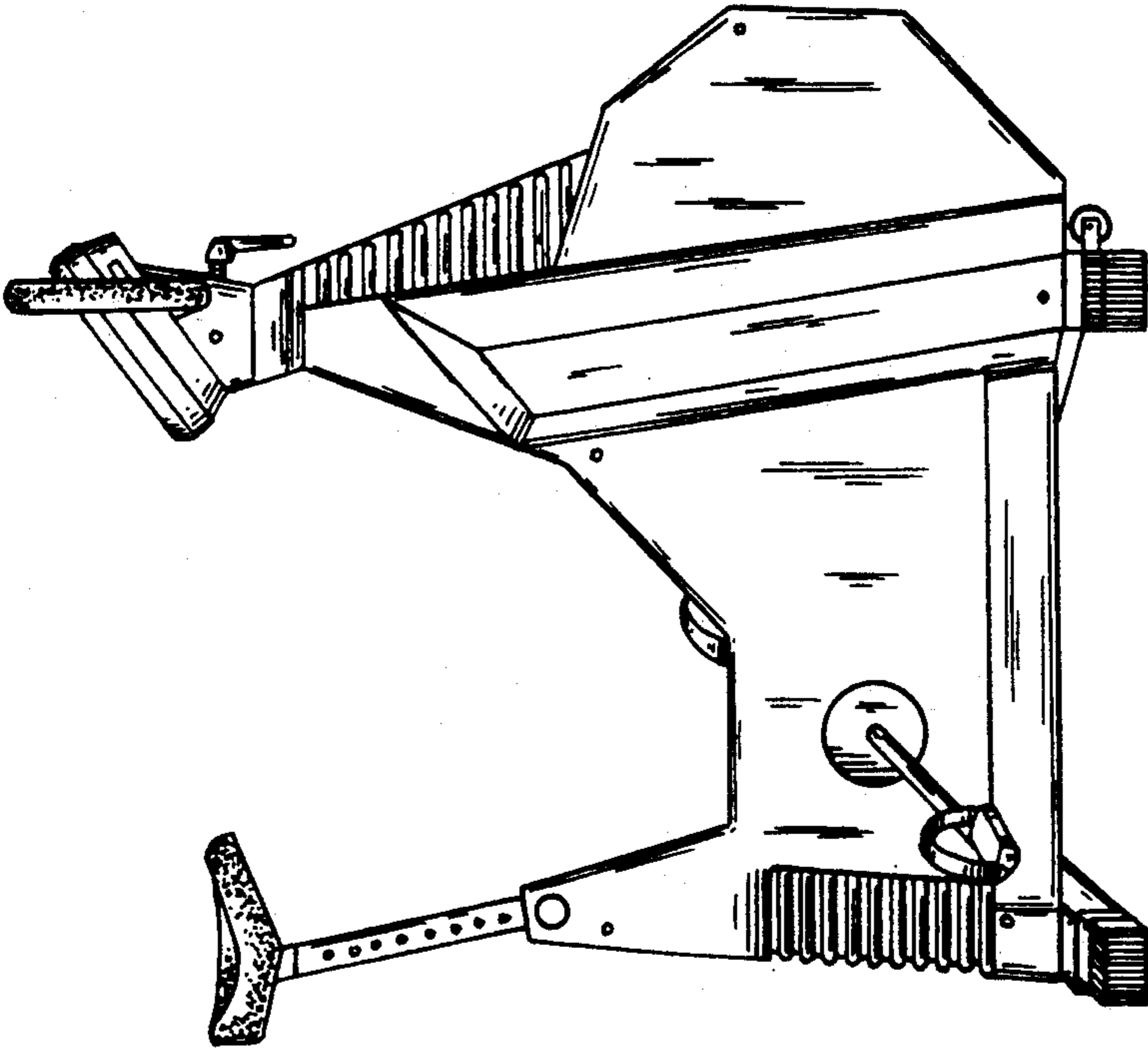

FIG. 1

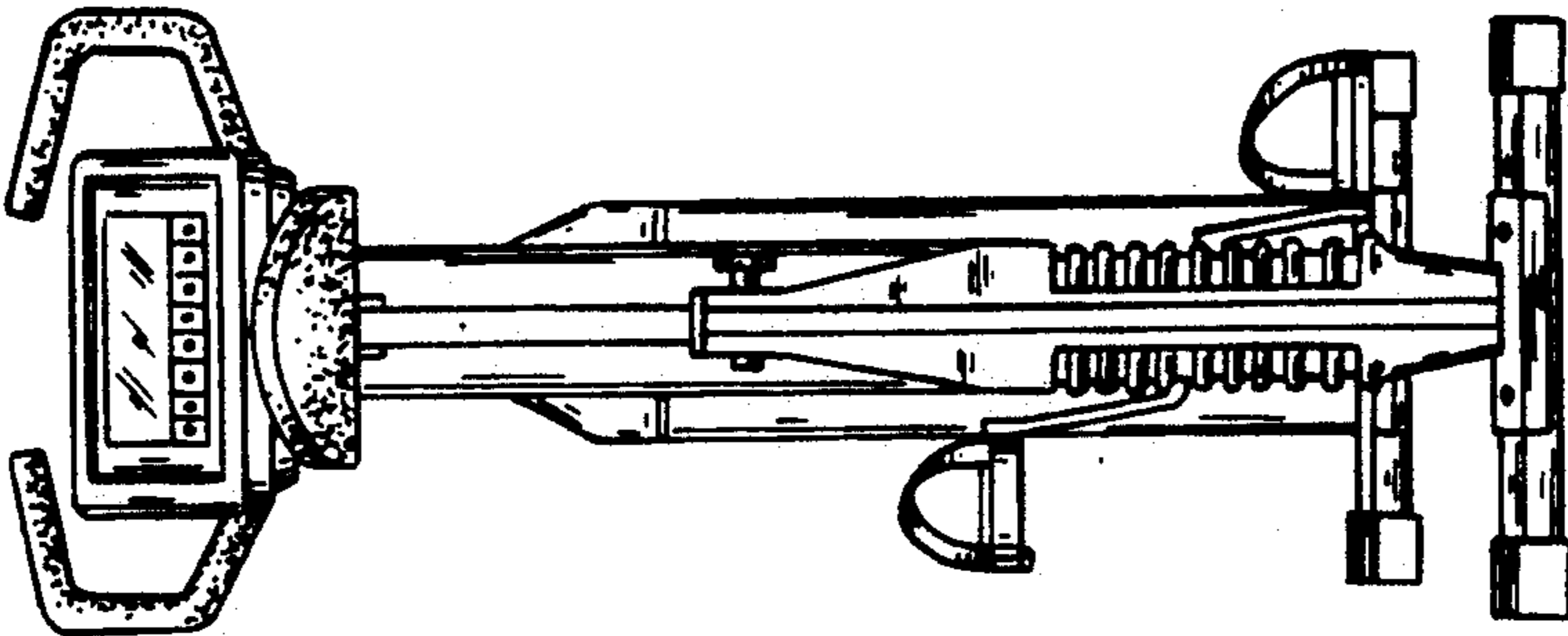

FIG. 3

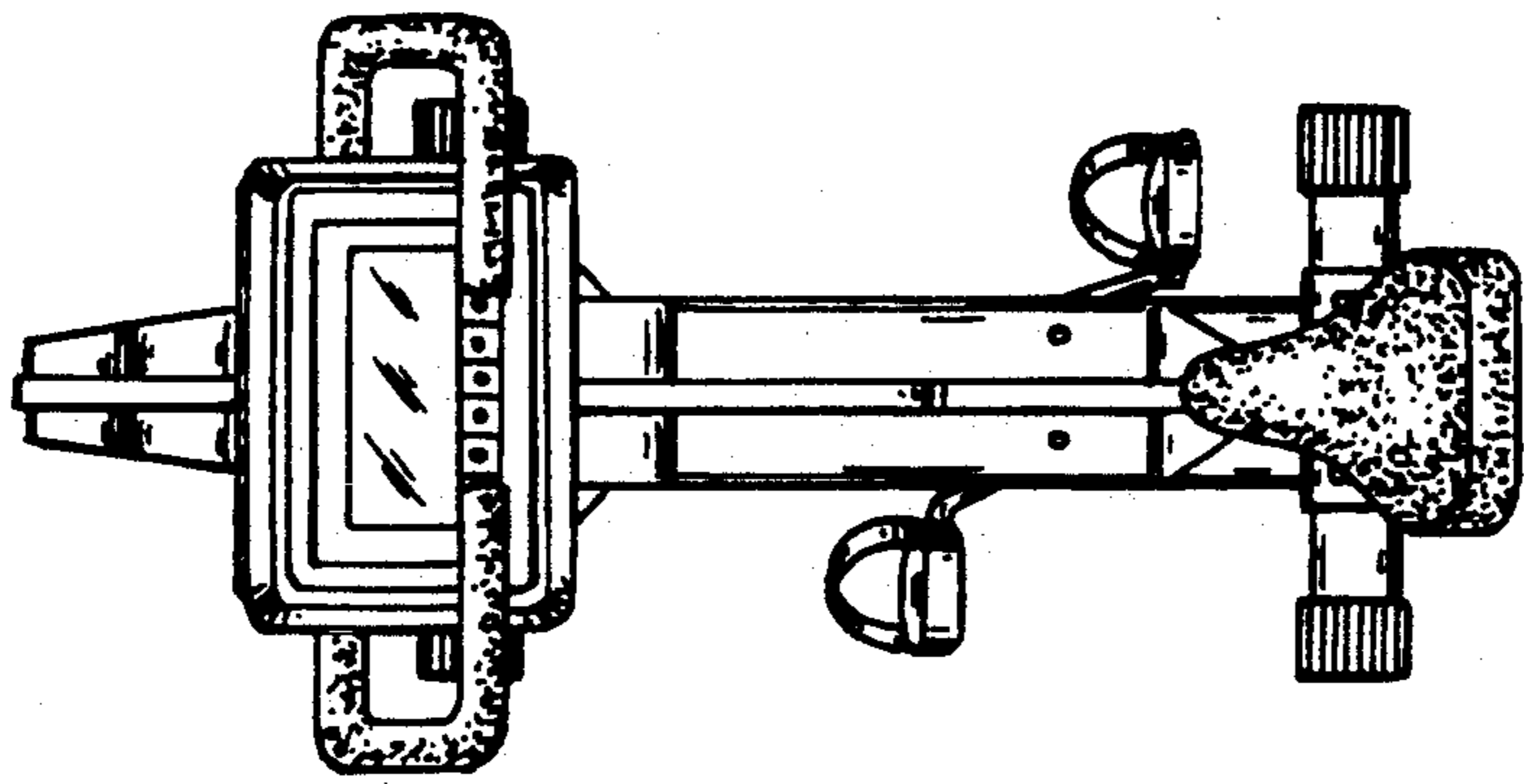

FIG. 4

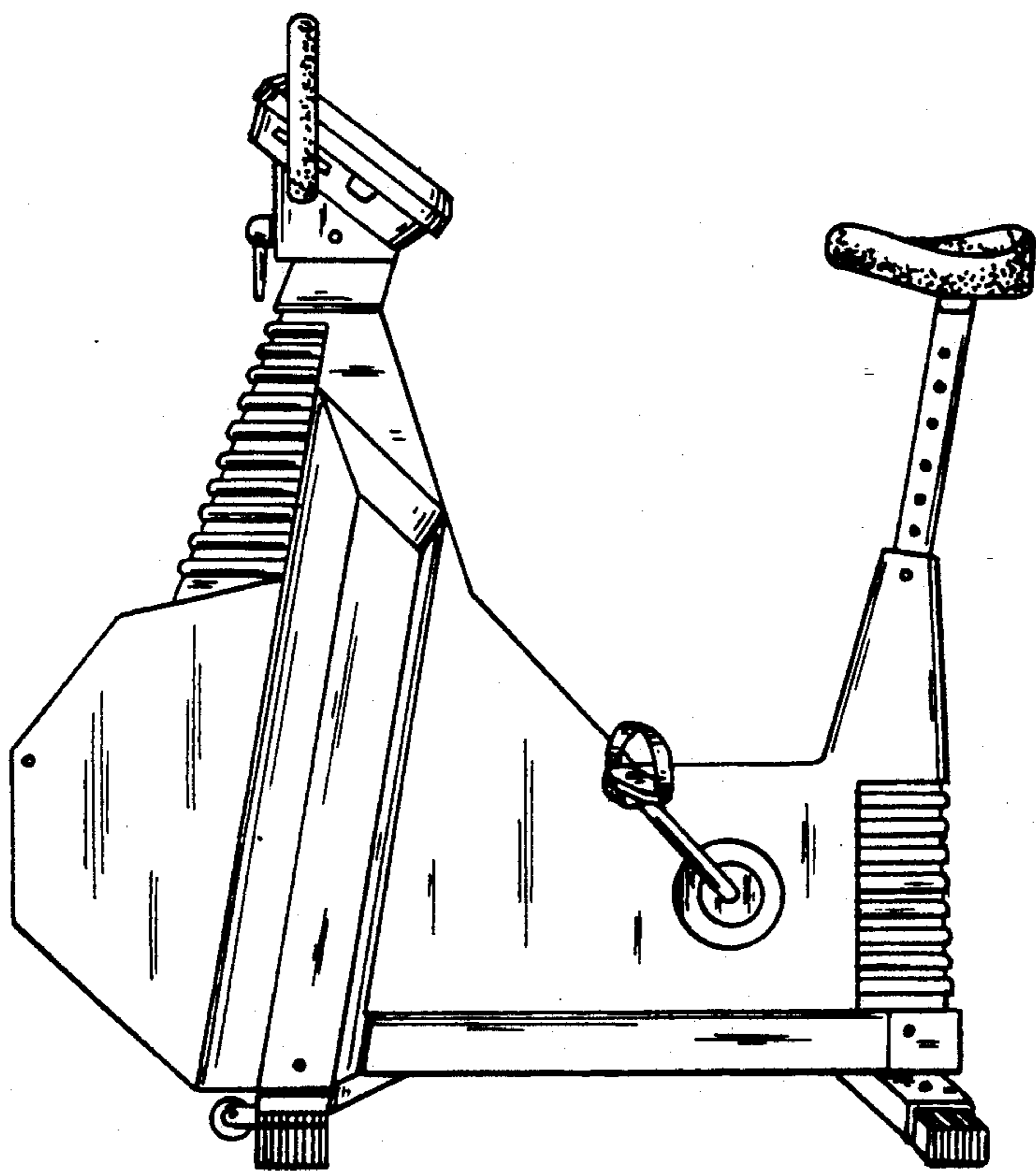

FIG. 5

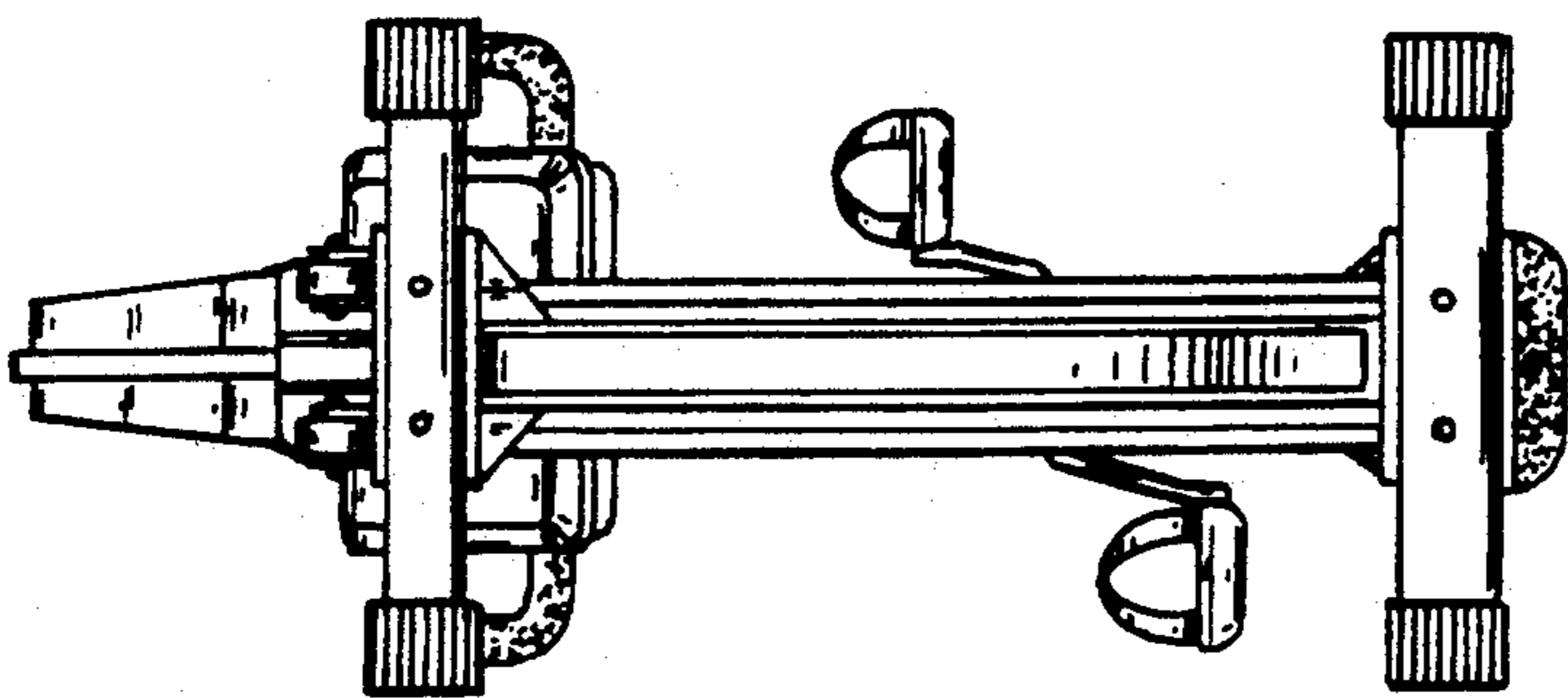

FIG. 6

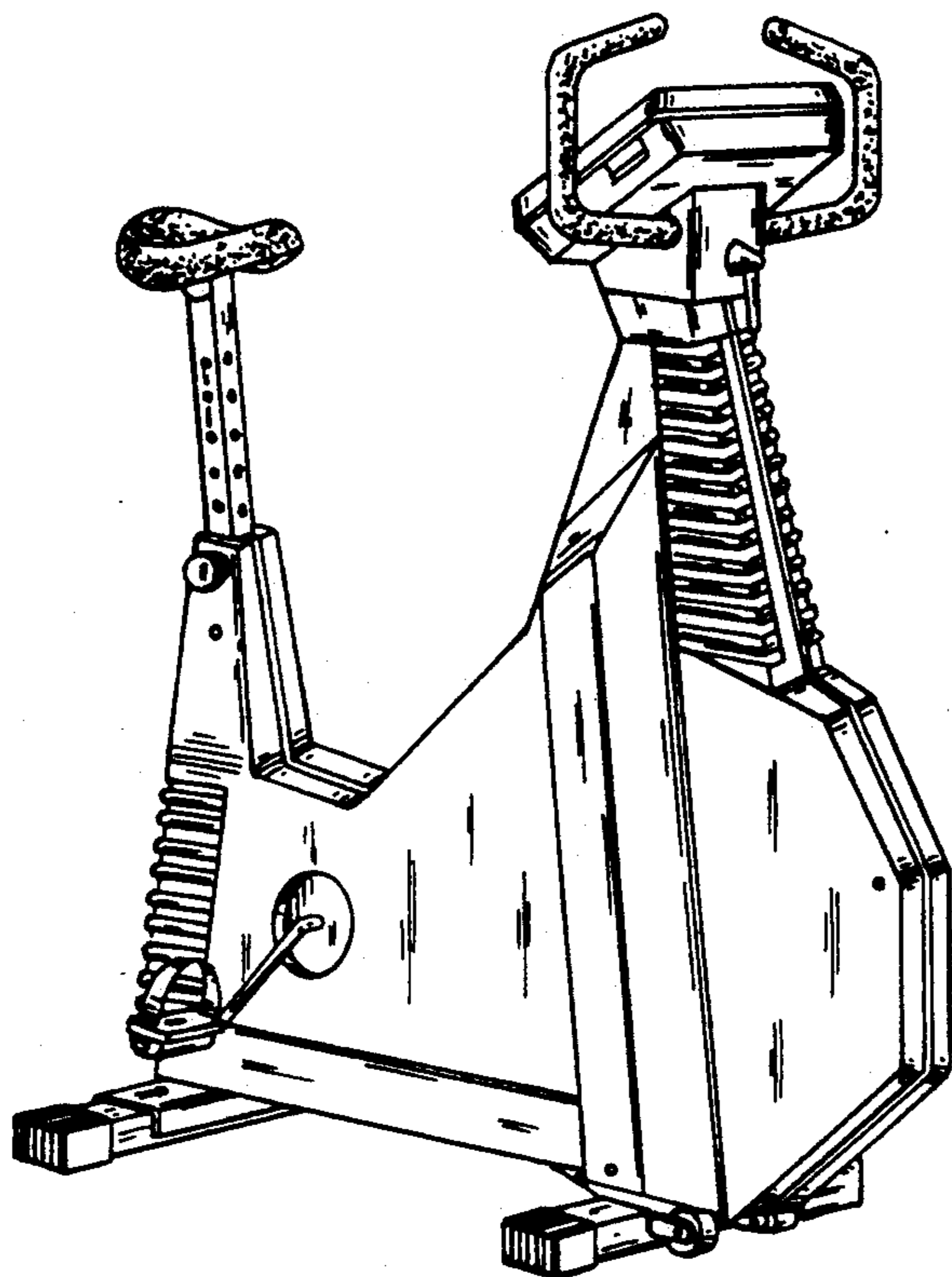

FIG. 7

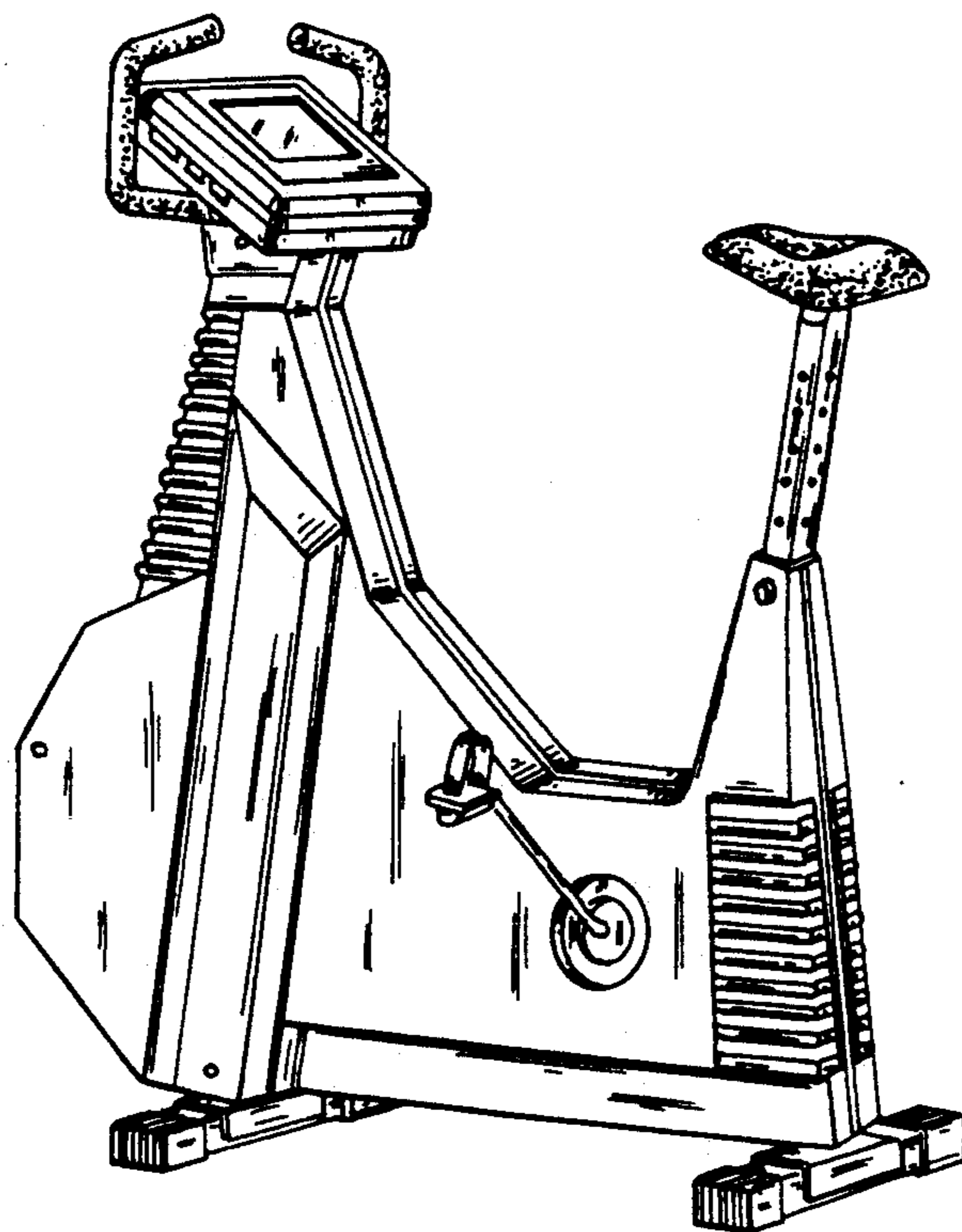

FIG. 8