



US00D338403S

# United States Patent [19]

[11] Patent Number: **Des. 338,403**

Hildebrand

[45] Date of Patent: **\*\* Aug. 17, 1993**

## [54] PACKAGING CONTAINER

[76] Inventor: **James Hildebrand**, 80 Iris Rd.,  
Warminster, Pa. 18974

[\*\*] Term: **14 Years**

[21] Appl. No.: **572,020**

[22] Filed: **Aug. 24, 1990**

[52] U.S. Cl. .... **D9/432; D9/341**

[58] Field of Search ..... **D9/432, 433, 423, 424,  
D9/414, 341; 206/223, 195, 547, 804, 566, 817,  
541, 362, 421; 220/23.83, 505, 93, 23.6; 229/23  
R**

4,545,487 10/1985 Asmus ..... 220/23.6 X  
4,807,776 2/1989 Cortopassi ..... 220/23.83  
5,000,372 3/1991 Hollander et al. .... 229/23 R

### OTHER PUBLICATIONS

Beauty Fashion, Nov. 1980, p. 14, Box as shown by  
arrow.

United States Box Corp. Cat/1982, p. 39, Box shown by  
arrow.

*Primary Examiner*—Bernard Ansher  
*Assistant Examiner*—Prabhakar Deshmukh  
*Attorney, Agent, or Firm*—Terry M. Gernstein

### [57] CLAIM

The ornamental design for a packaging container, as  
shown and described.

### [56] References Cited

#### U.S. PATENT DOCUMENTS

D. 275,178 8/1986 Ewry ..... D9/432  
2,667,915 2/1954 Pfeffer .  
2,822,970 2/1958 Froggatt et al. .... 229/23 R  
2,887,263 5/1959 Wright ..... 229/23 R  
3,204,853 9/1965 Hoyne et al. .... D9/432 X  
3,416,655 12/1968 Shiffman ..... 206/566 X  
3,515,267 6/1970 Rocca .  
3,655,500 4/1972 Johnson .

### DESCRIPTION

FIG. 1 is an exploded perspective view of a packaging  
container showing my new design;  
FIG. 2 is a rear elevational view thereof;  
FIG. 3 is a left side elevational view thereof; the right  
side elevational view being a mirror image thereof;  
FIG. 4 is a top plan view thereof; and,  
FIG. 5 is a bottom plan view thereof.

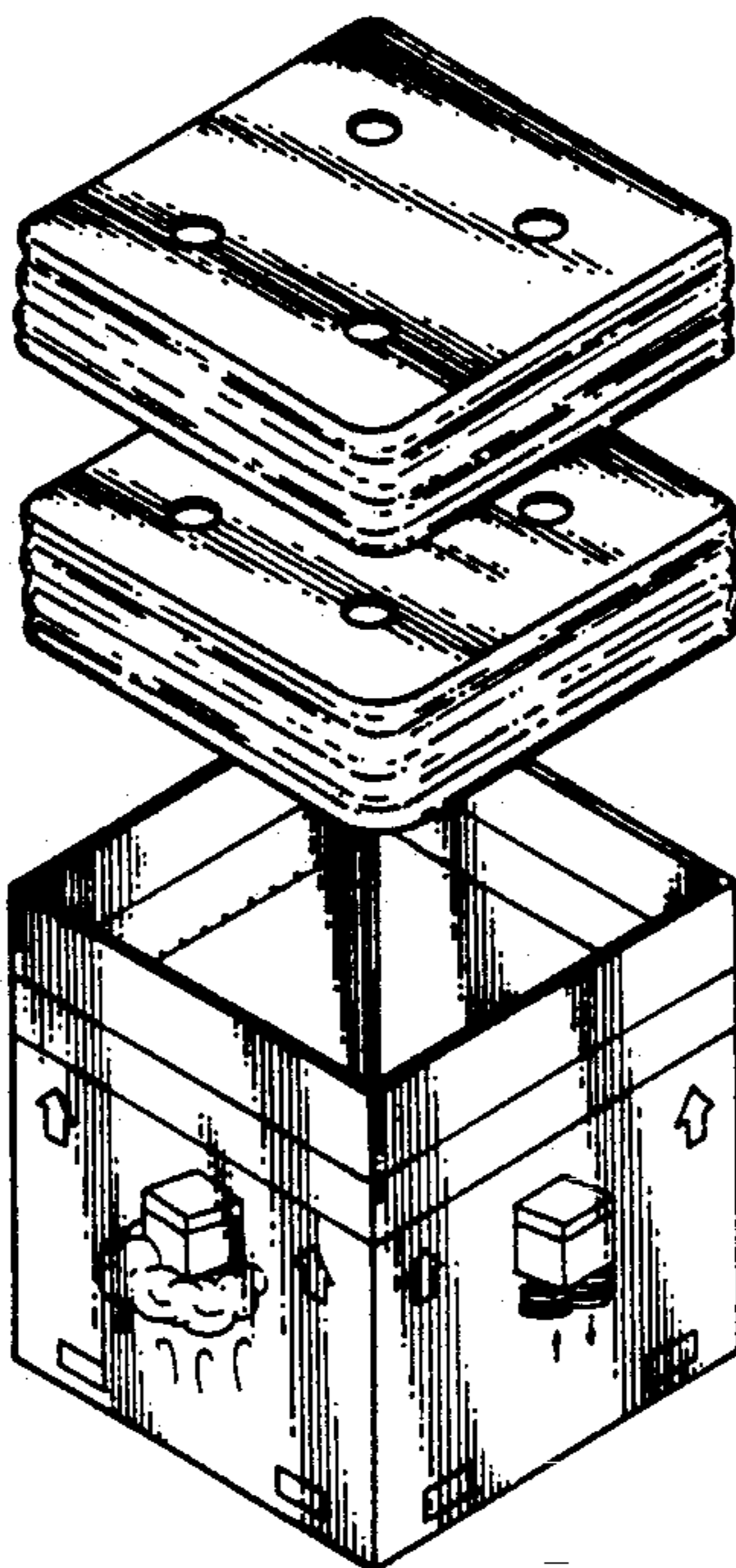
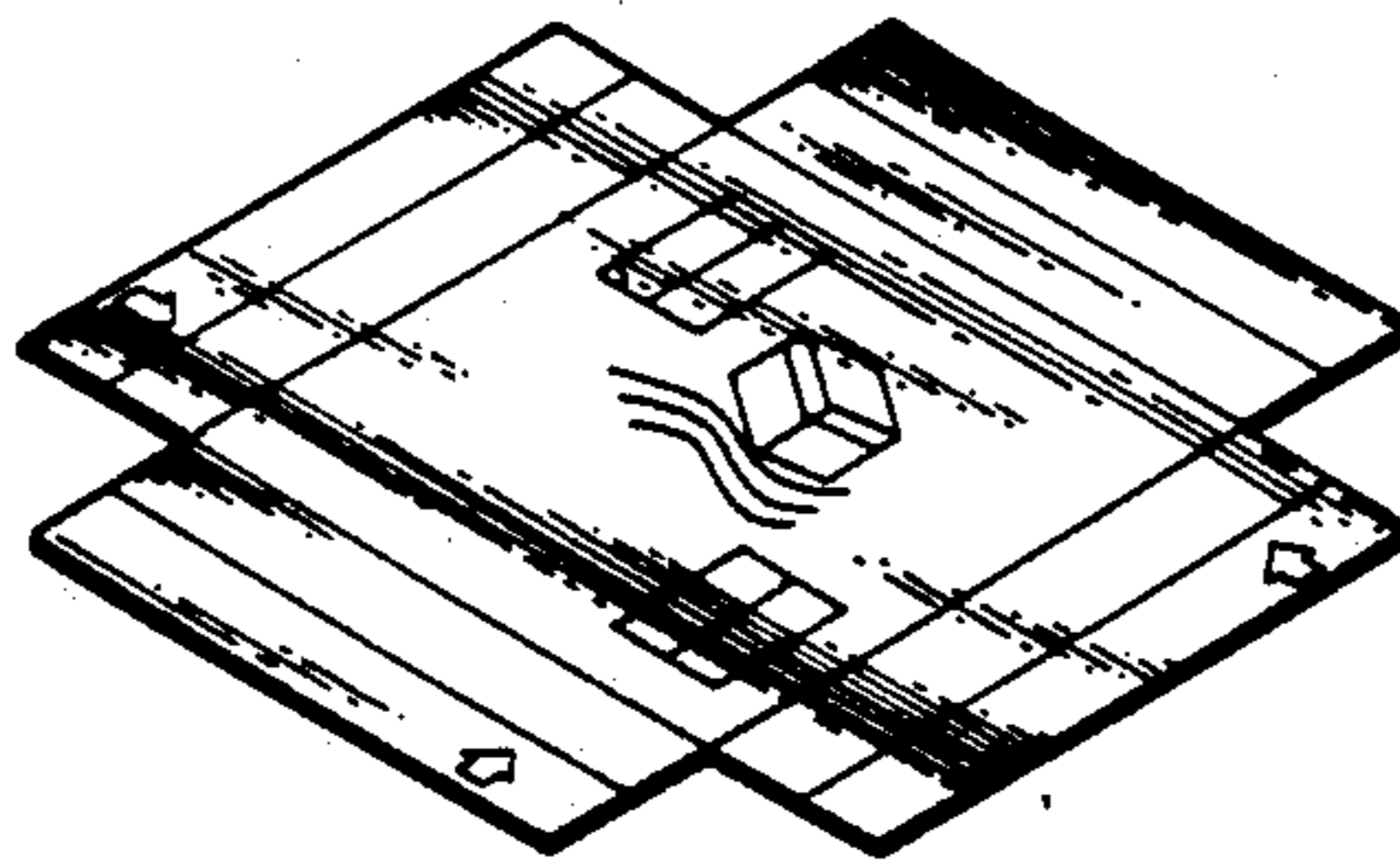
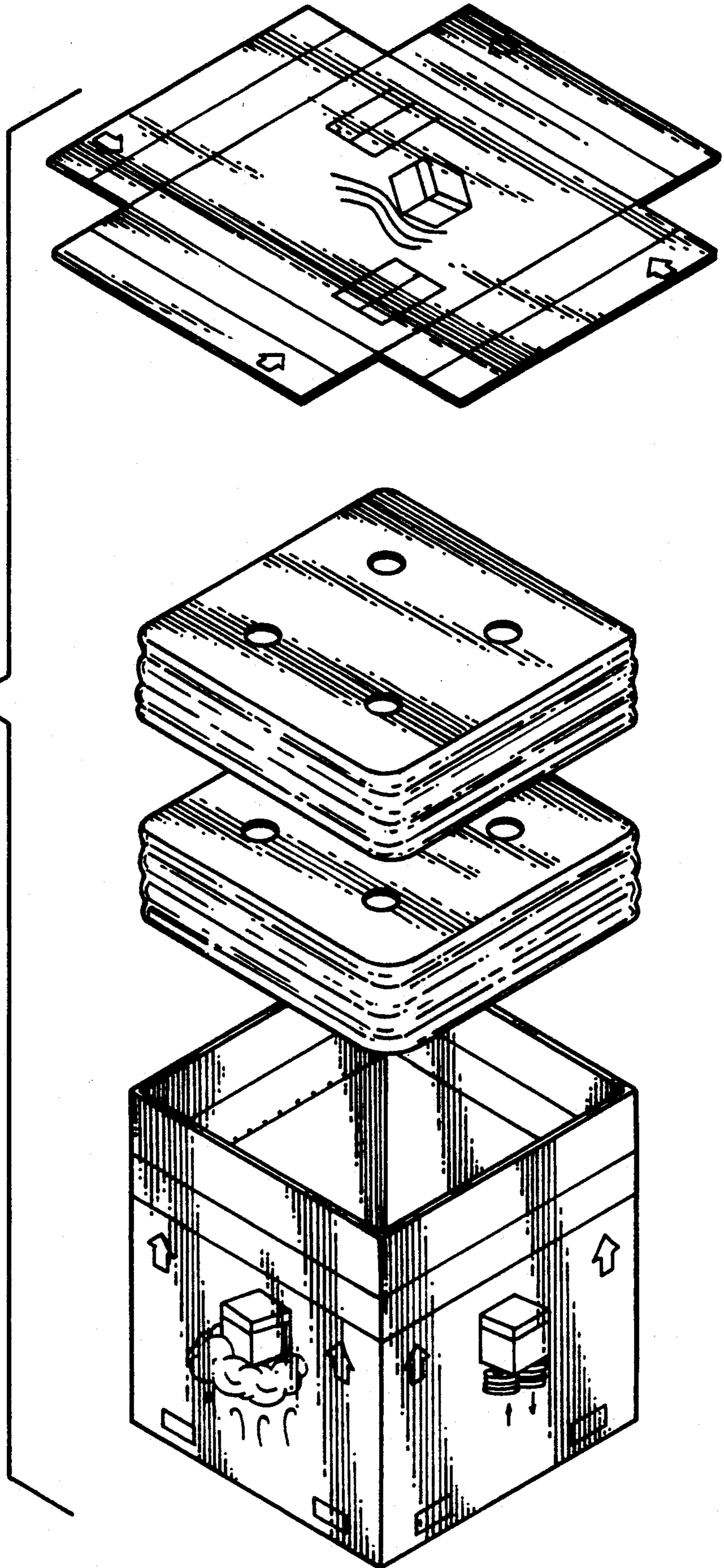

FIG. 1



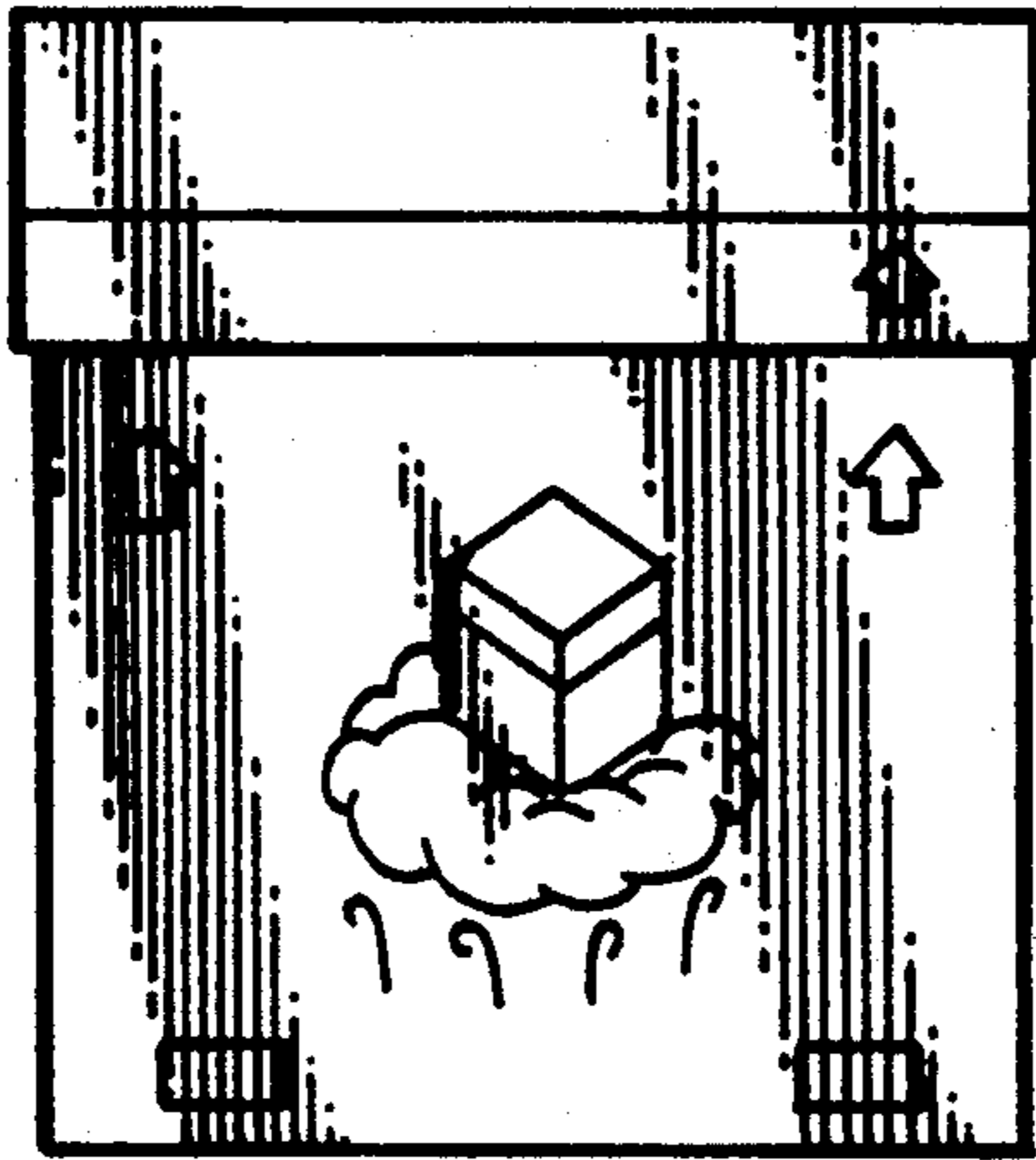

FIG. 2

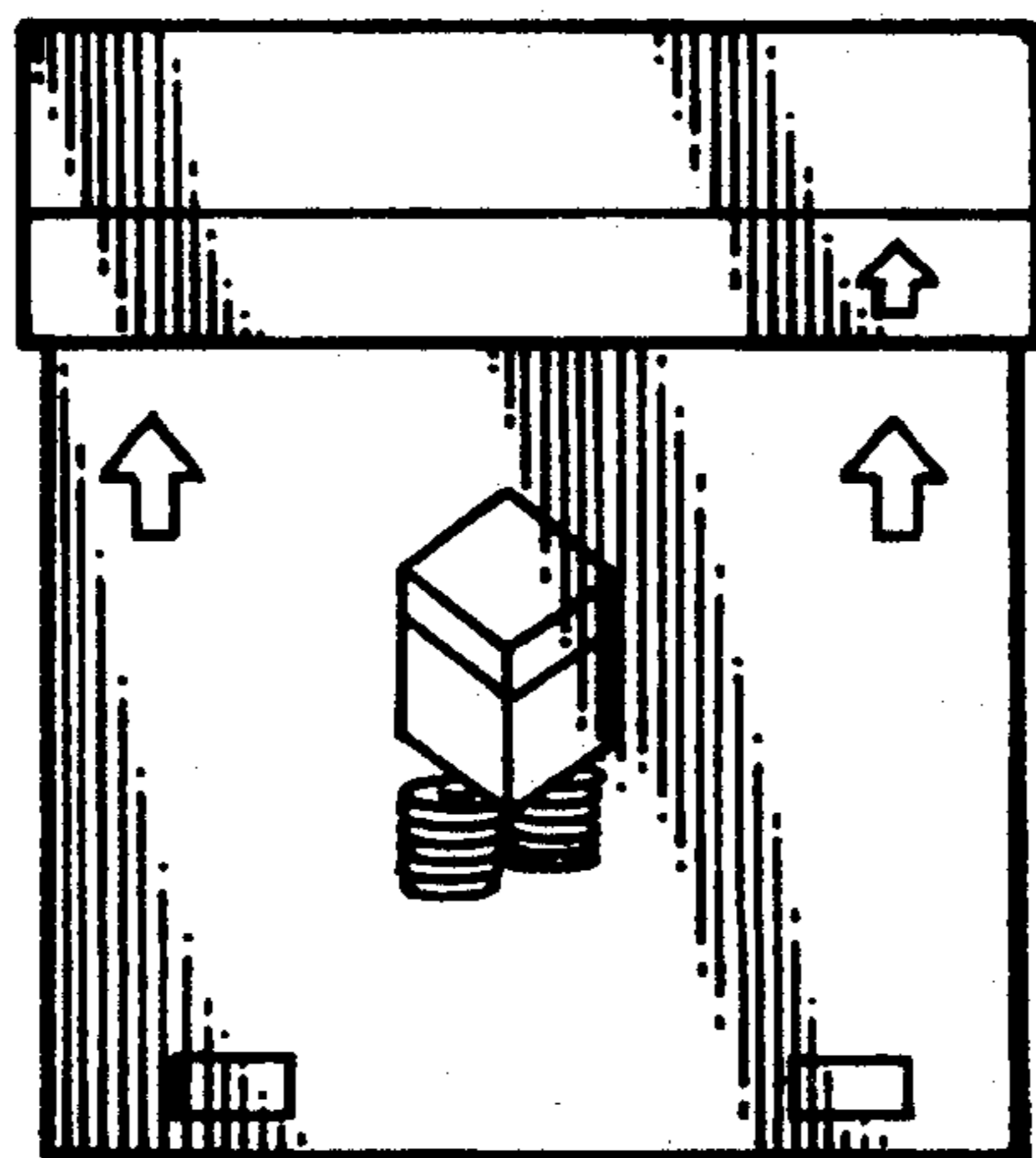

FIG. 3

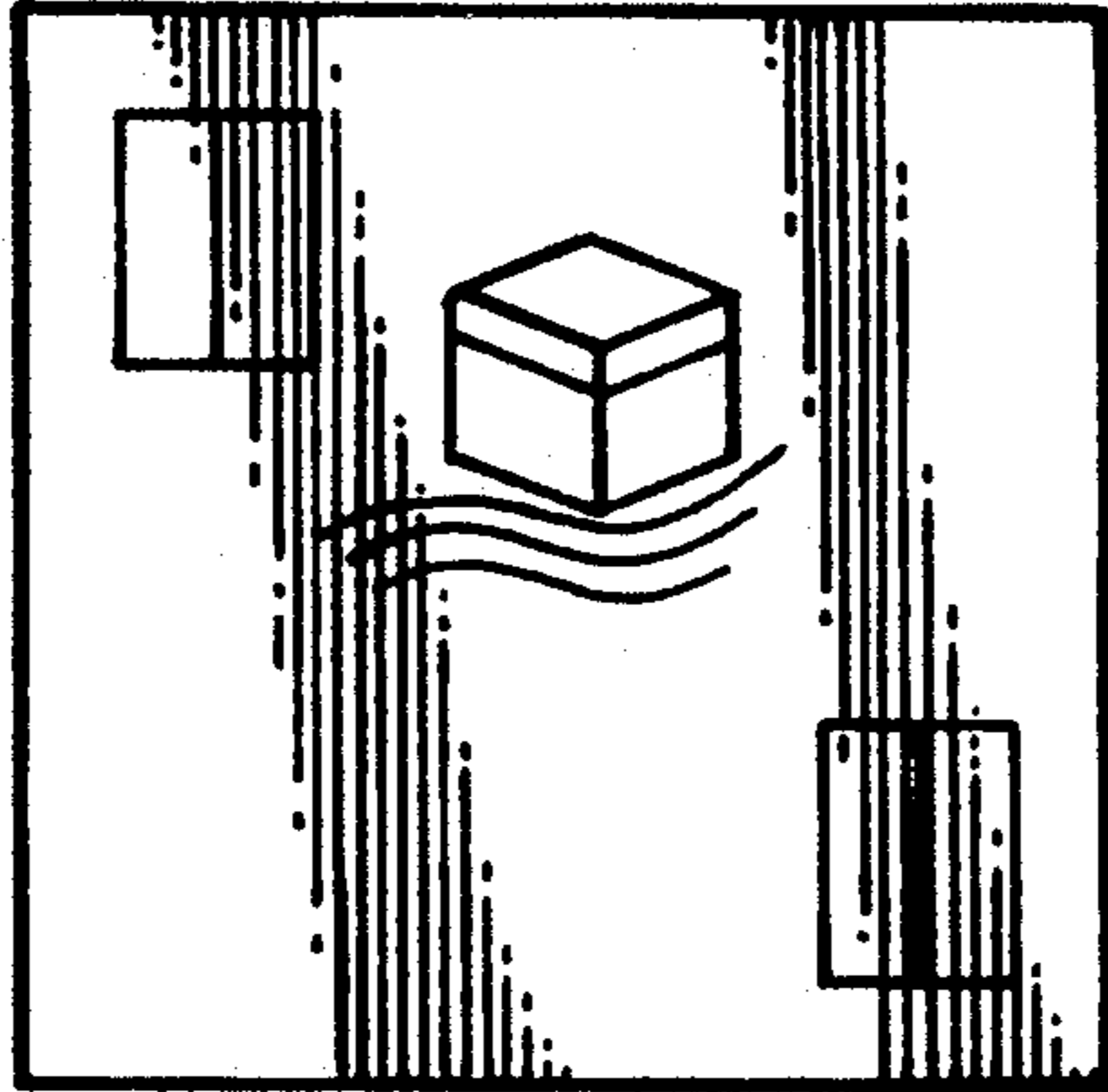

FIG. 4

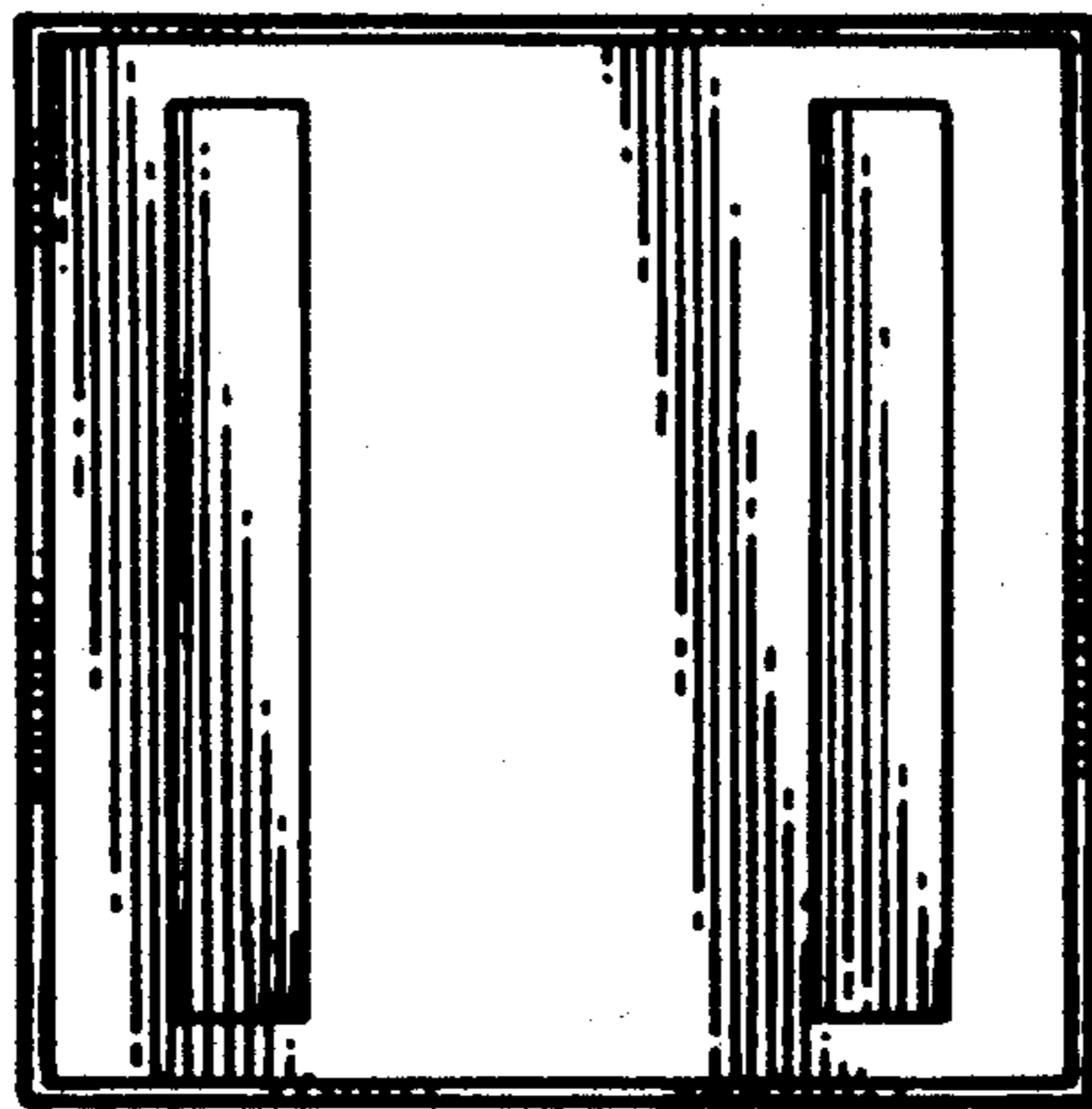

FIG. 5