



US00D338334S

# United States Patent [19]

[11] Patent Number: **Des. 338,334**

**Kopel et al.**

[45] Date of Patent: **\*\* Aug. 17, 1993**

[54] **COMBINED PURSE AND WALLET**

[75] Inventors: **David Kopel, Chatsworth; John I. Cisowski, West Hills, both of Calif.**

[73] Assignee: **Koltov, Inc., Chatsworth, Calif.**

[\*\*] Term: **14 Years**

[21] Appl. No.: **1,744**

[22] Filed: **Nov. 20, 1992**

**Related U.S. Application Data**

[63] Continuation-in-part of Ser. No. 699,779, May 13, 1991, Pat. No. Des. 332,866.

[52] U.S. Cl. .... **D3/43; D3/56**

[58] Field of Search ..... **D3/42-48, D3/52-60, 62; 150/100, 103-108, 110-113, 117-119, 134, 135, 143; 132/318; 190/1, 100, 115, 107-112; 383/4, 907; 224/252; 206/235, 581**

[56] **References Cited**

**U.S. PATENT DOCUMENTS**

D. 161,264	12/1950	Jeffery	.....	D3/60
D. 181,628	12/1957	Chase	.....	D3/58
D. 183,085	6/1958	Chase	.....	D3/58
D. 183,711	10/1958	Blaivas	.....	D3/59
D. 184,712	3/1959	Chase	.....	D3/58
D. 190,943	7/1961	Smallman	.....	D3/57
D. 216,173	11/1969	Koguff	.....	D3/58
D. 263,898	4/1982	Linke	.....	D3/56
D. 312,351	11/1990	Bishop	.....	D3/58
D. 322,715	12/1991	Bishop	.....	D3/56
587,251	7/1897	Wilentshik	.....	D3/58 X
2,092,834	9/1937	Doppelt	.....	D3/59 X
2,160,364	5/1939	Kannor	.....	D3/59 X
2,321,462	6/1943	Conant	.....	132/318 X
2,477,840	8/1949	Vasilas	.....	D3/59 X
3,016,940	1/1962	Mullin	.....	D3/62 X
3,946,781	3/1976	Reis	.....	D3/60 X
4,044,933	8/1977	Artz	.....	224/252 X
4,126,168	11/1978	Ganz	.....	D3/56 X
4,153,093	5/1979	Mahabir	.....	150/143 X
4,555,020	11/1985	Campello et al.	.....	206/235
4,705,086	11/1987	O'Neil	.....	150/134
4,907,634	3/1990	Yoo	.....	150/135
5,020,673	6/1991	Adams	.....	206/581
5,046,620	9/1991	Barabino	.....	206/581

*Primary Examiner—Louis S. Zarfes*  
*Attorney, Agent, or Firm—Freilich, Hornbaker, Rosen*

[57] **CLAIM**

The ornamental design for a combined purse and wallet, as shown and described.

**DESCRIPTION**

FIG. 1 is a front elevational view of a first embodiment of a combined purse and wallet showing our new design;  
 FIG. 2 is a top plan view of said first embodiment;  
 FIG. 3 is a rear elevational view of said first embodiment;  
 FIG. 4 is a bottom plan view of said first embodiment;  
 FIG. 5 is a left side elevational view of said first embodiment;  
 FIG. 6 is a right side elevational view of said first embodiment;  
 FIG. 7 is a front elevational view of a second embodiment of a combined purse and wallet showing our new design;  
 FIG. 8 is a top plan view of said second embodiment;  
 FIG. 9 is a rear elevational view of said second embodiment;  
 FIG. 10 is a bottom plan view of said second embodiment;  
 FIG. 11 is a left side elevational view of said second embodiment;  
 FIG. 12 is a right side elevational view of said second embodiment;  
 FIG. 13 is a front elevational view of a third embodiment of a combined purse and wallet showing our new design;  
 FIG. 14 is a top plan view of said third embodiment;  
 FIG. 15 is a rear elevational view of said third embodiment;  
 FIG. 16 is a bottom plan view of said third embodiment;  
 FIG. 17 is a left side elevational view of said third embodiment; and,  
 FIG. 18 is a right side elevational view of said third embodiment.

The broken line showings of a lipstick, brush/comb, calculator and nail file in FIGS. 1,7 and 13 are for illustrative purposes only and form no part of the claimed design.

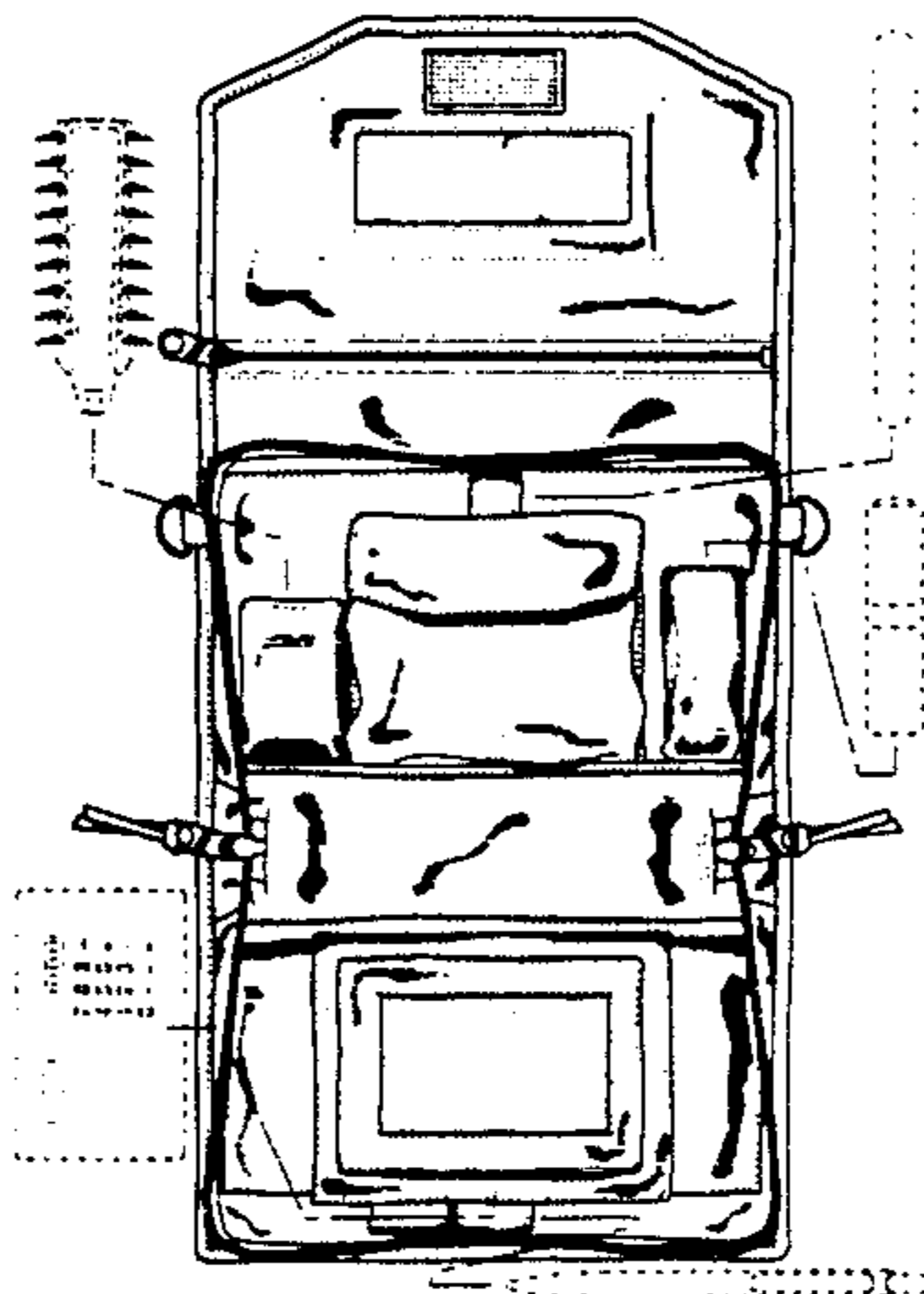

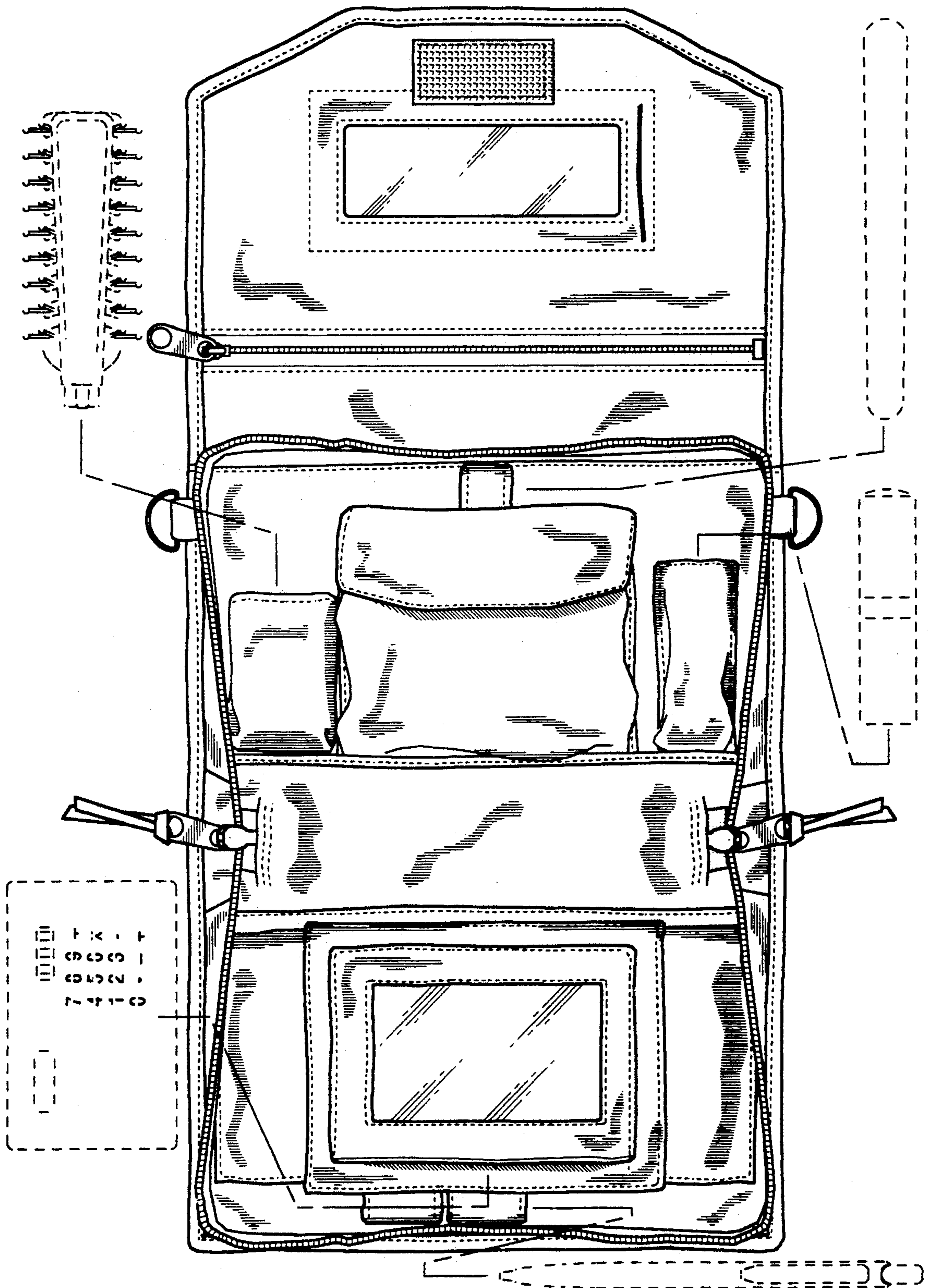

FIG. 1

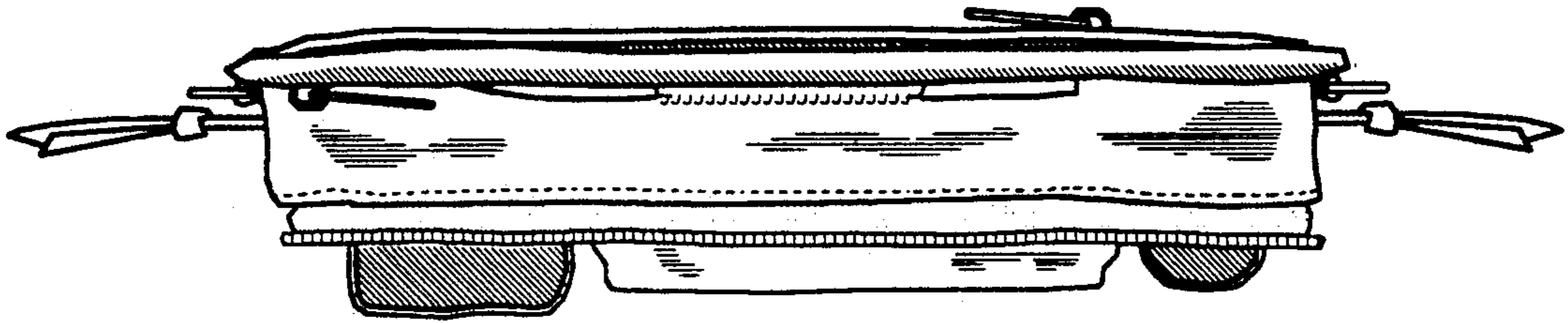

FIG. 2

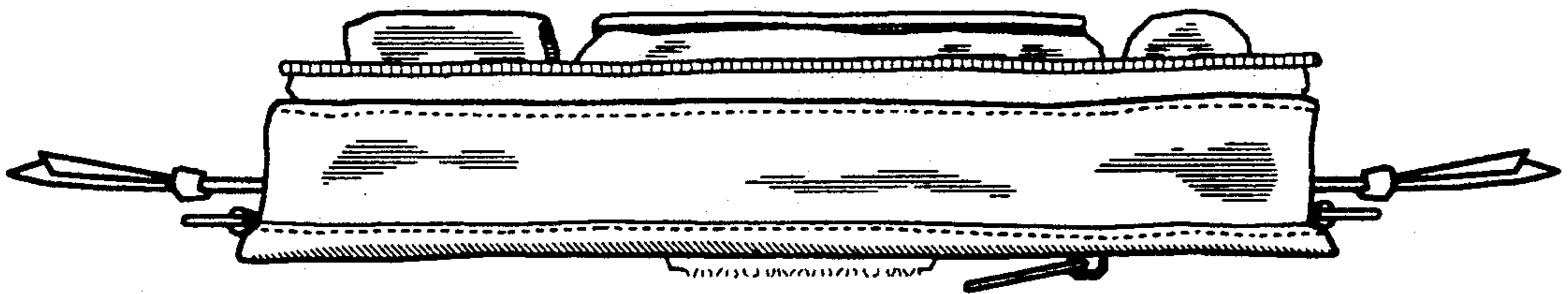

FIG. 4

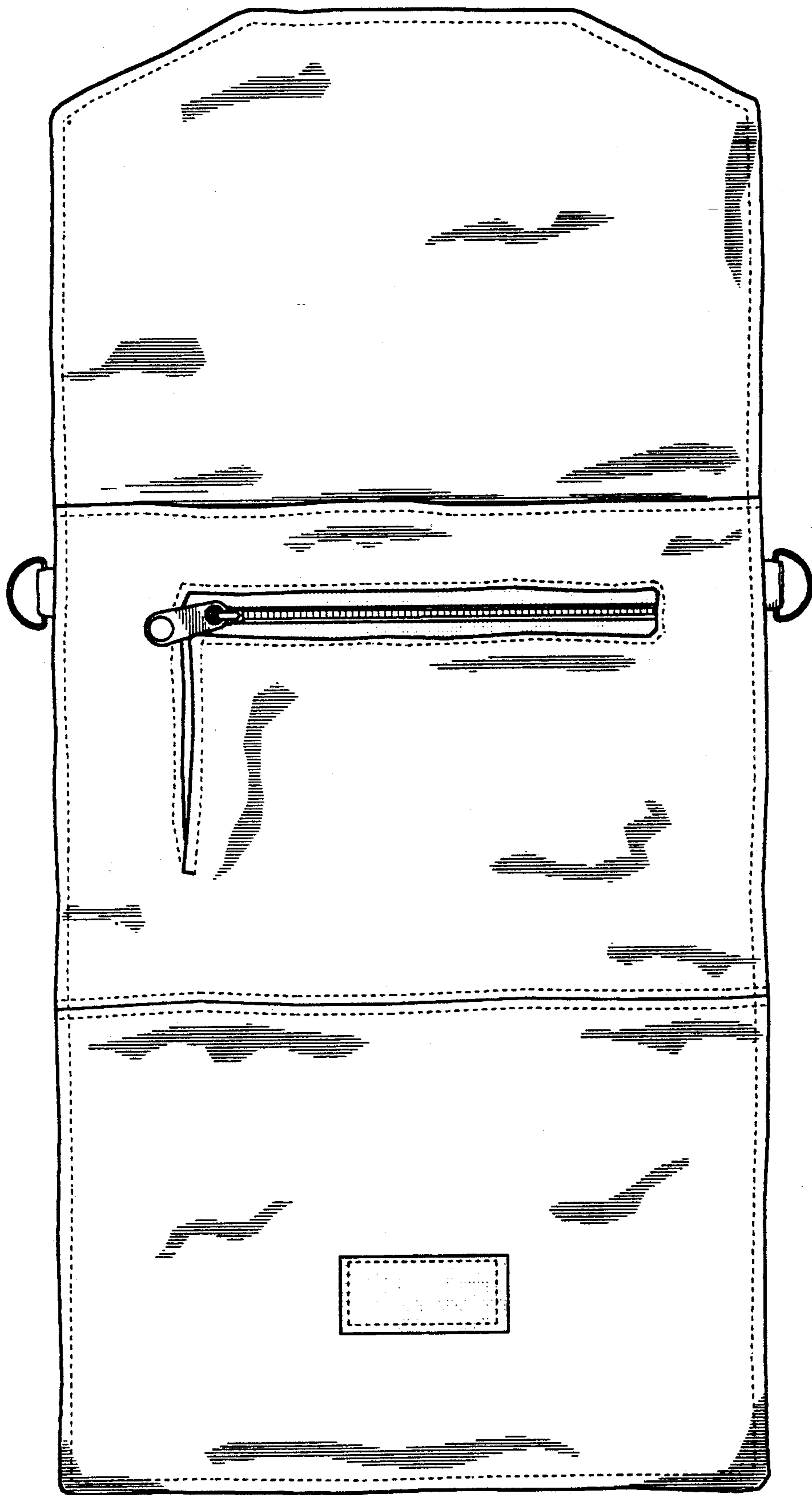

FIG. 3

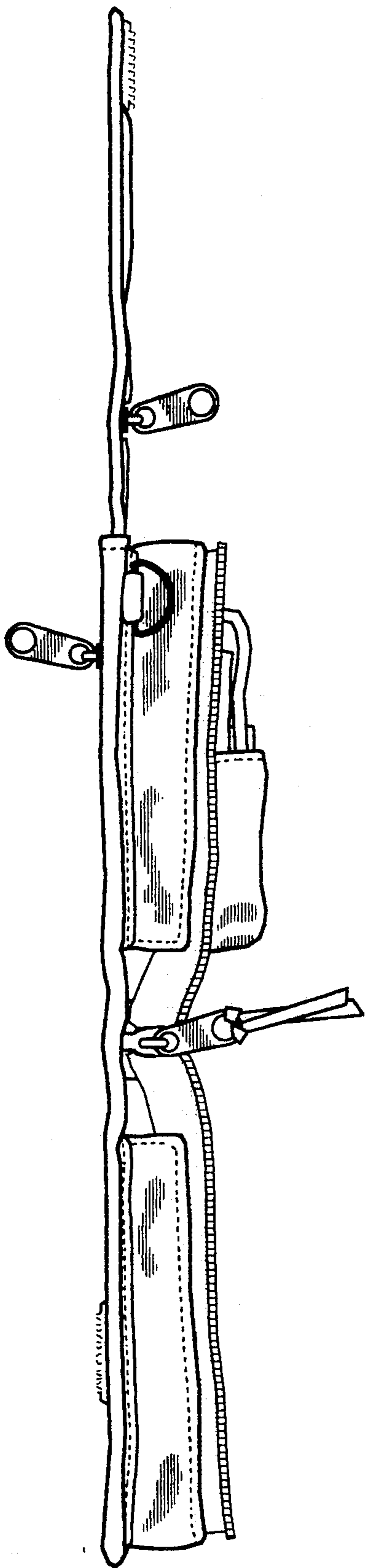

FIG. 5

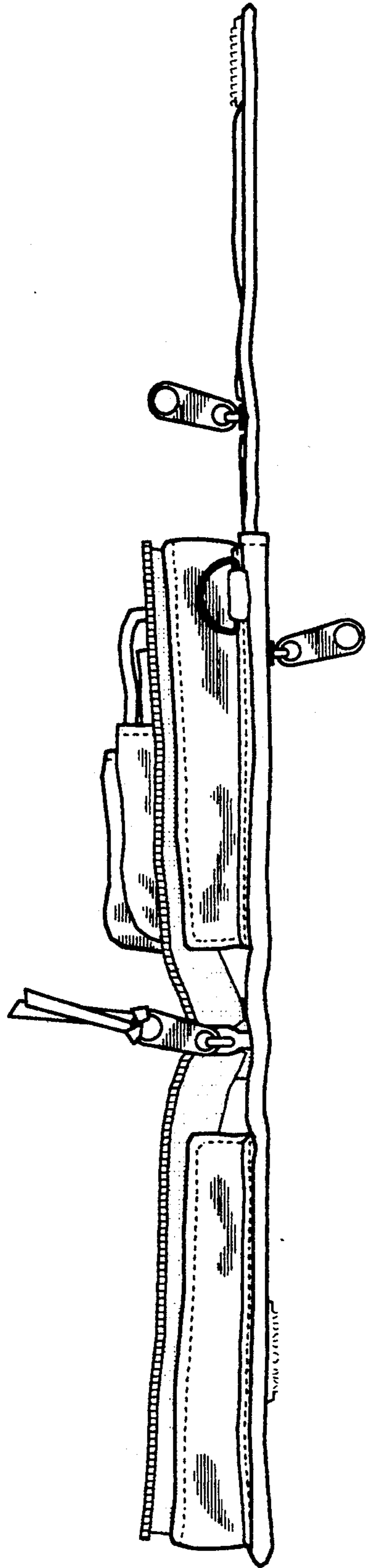

FIG. 6

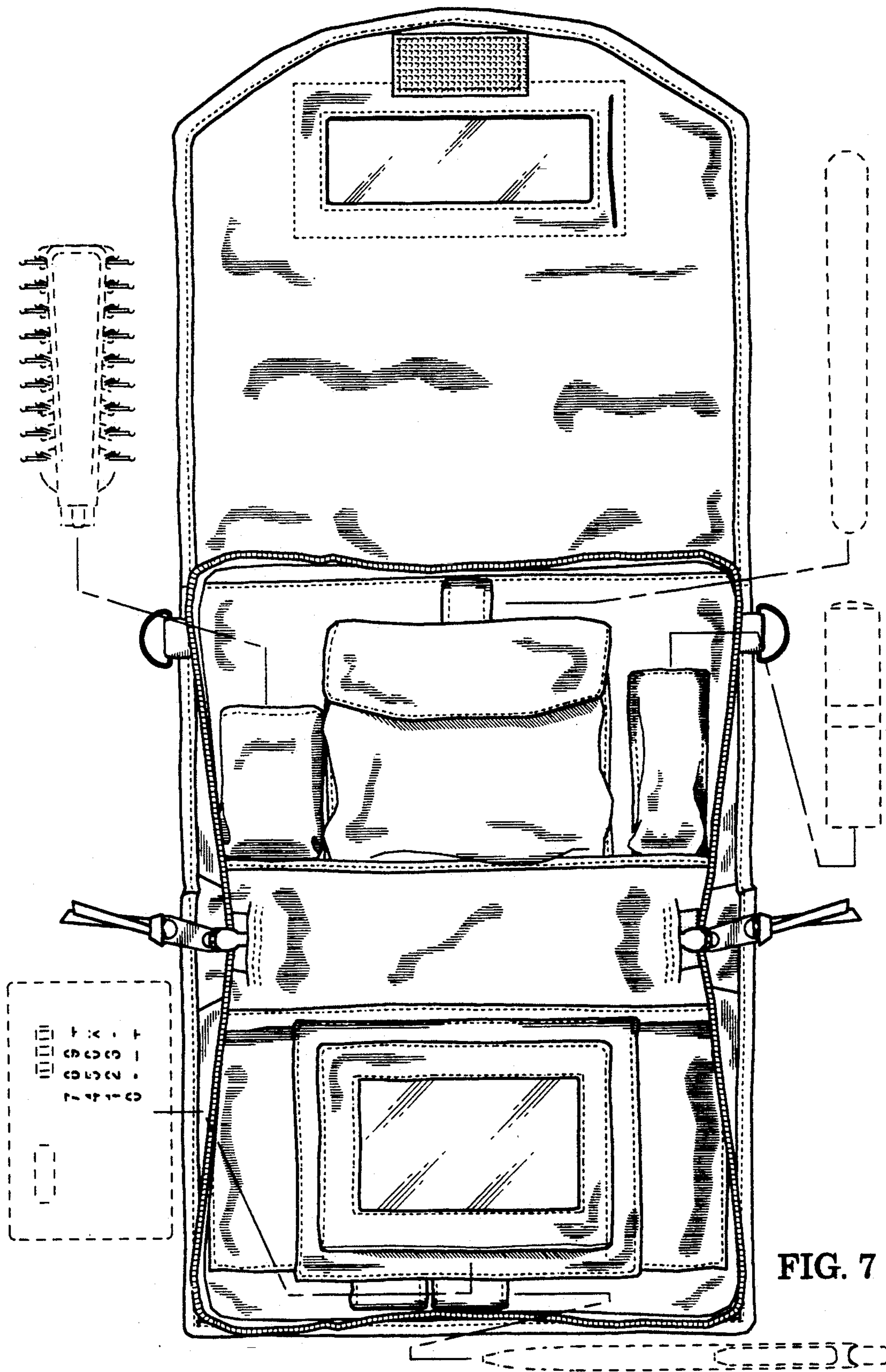

FIG. 7

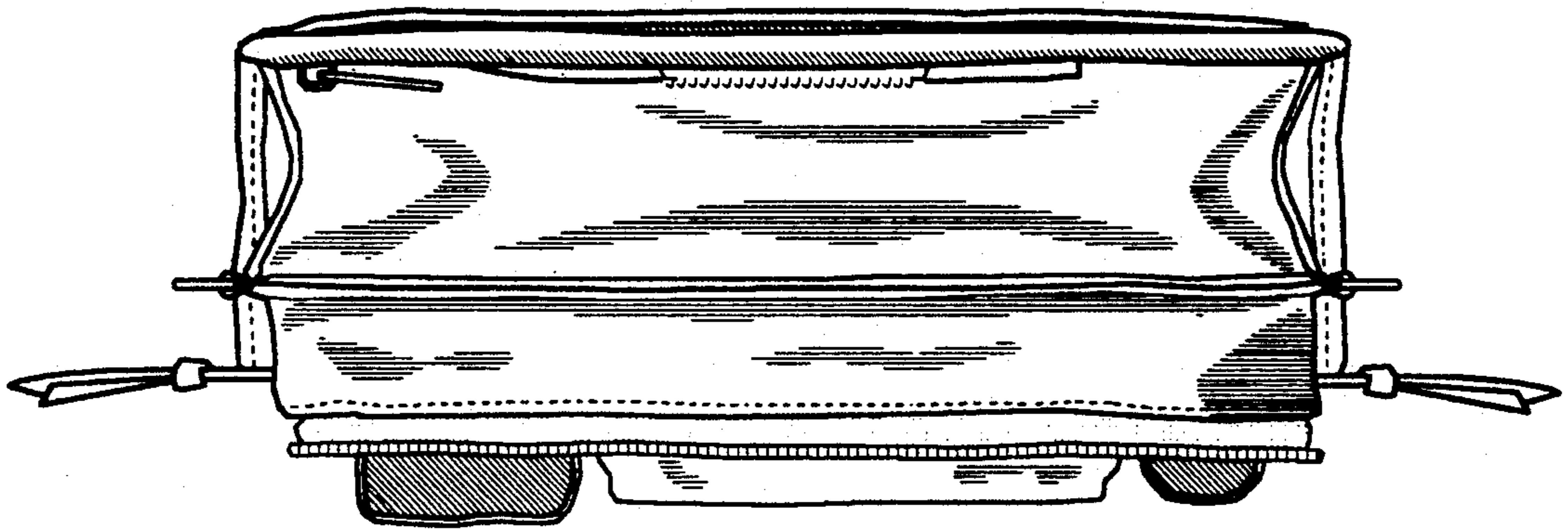

FIG. 8

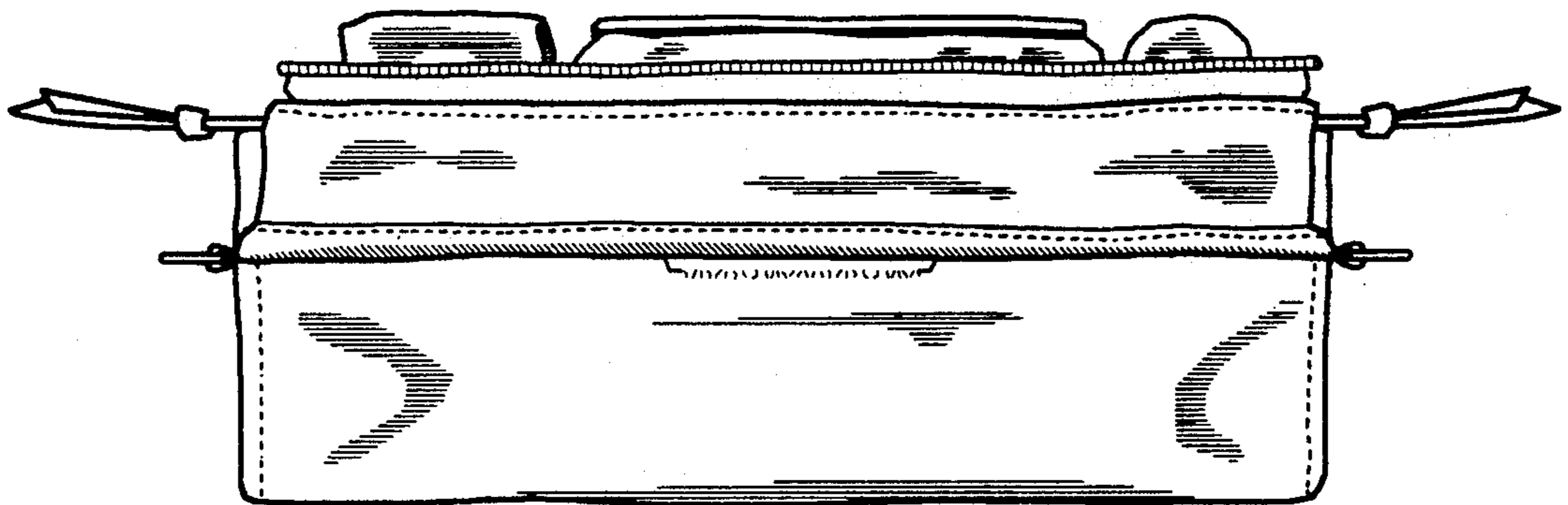

FIG. 10

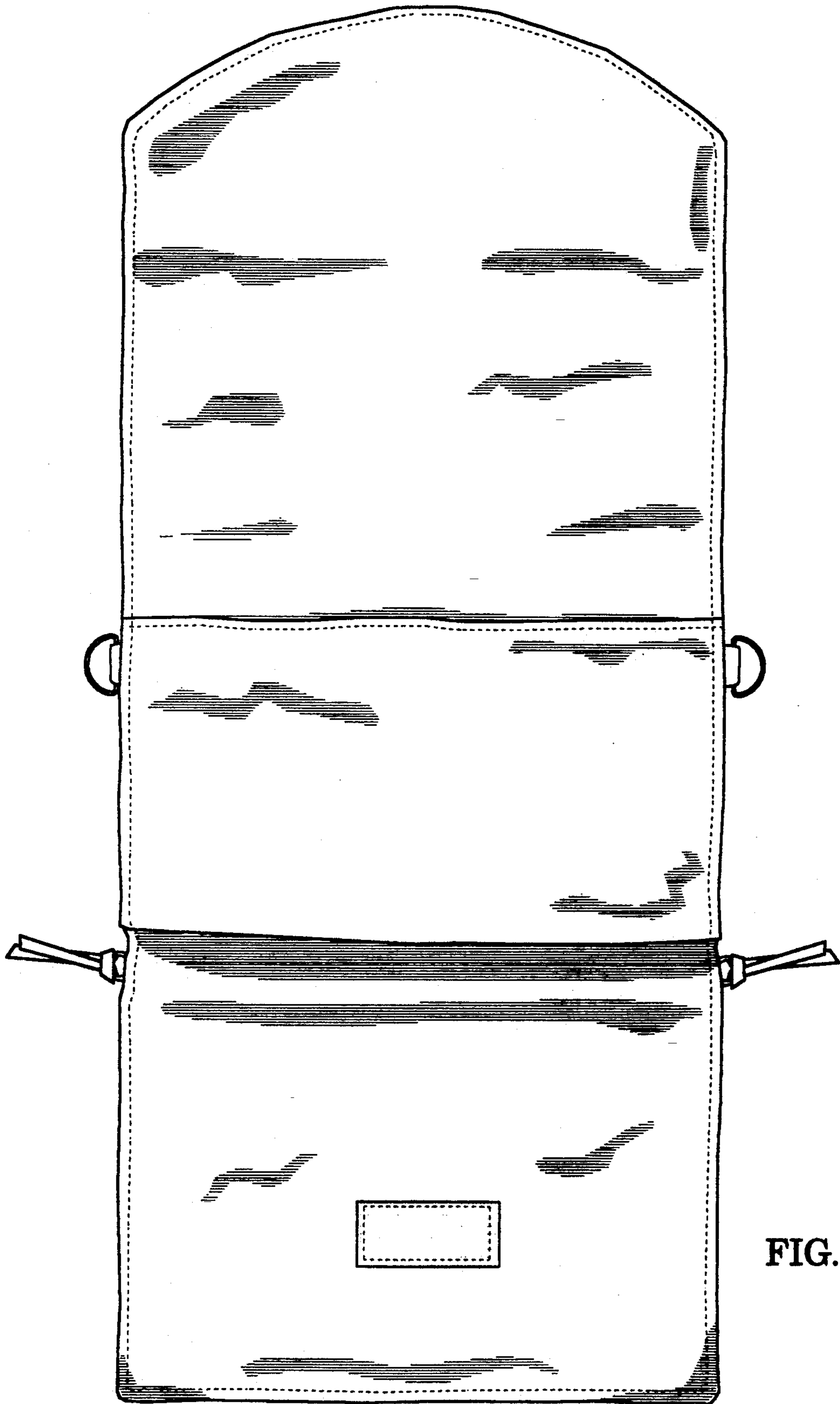

FIG. 9



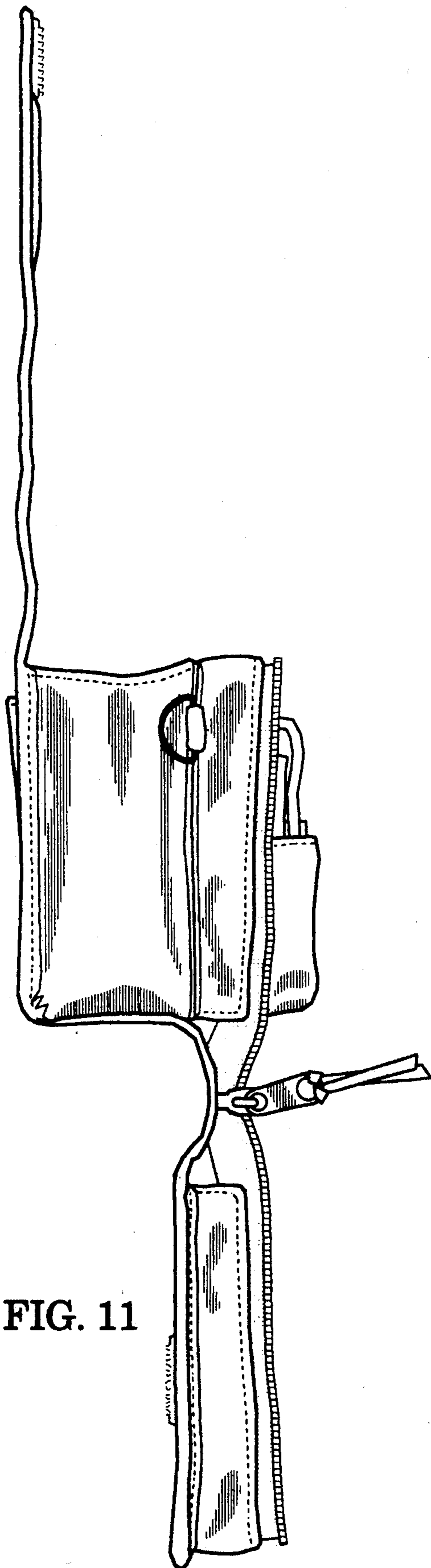

FIG. 11

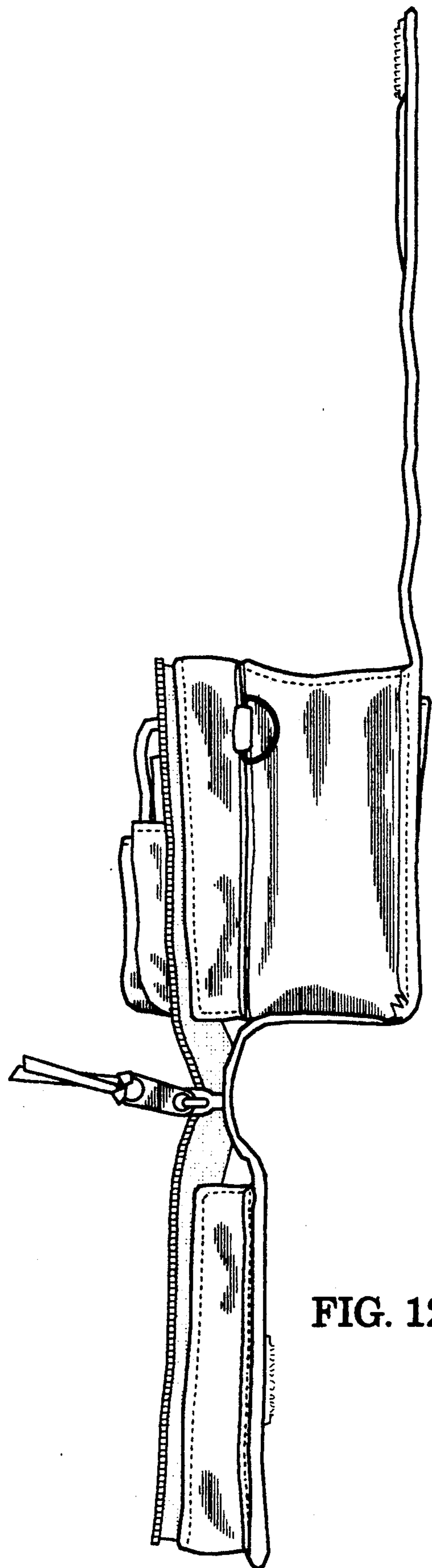

FIG. 12

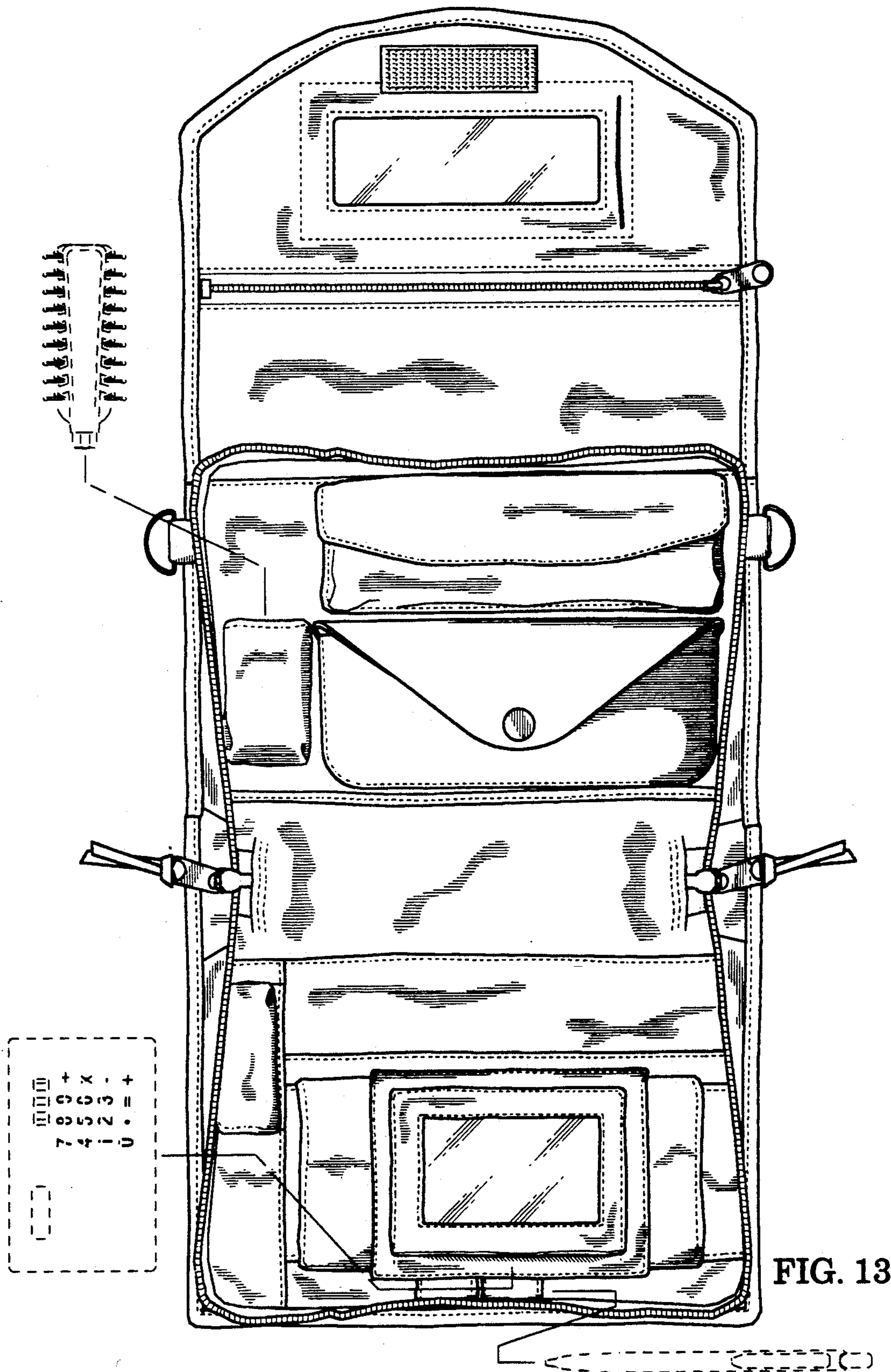

FIG. 13

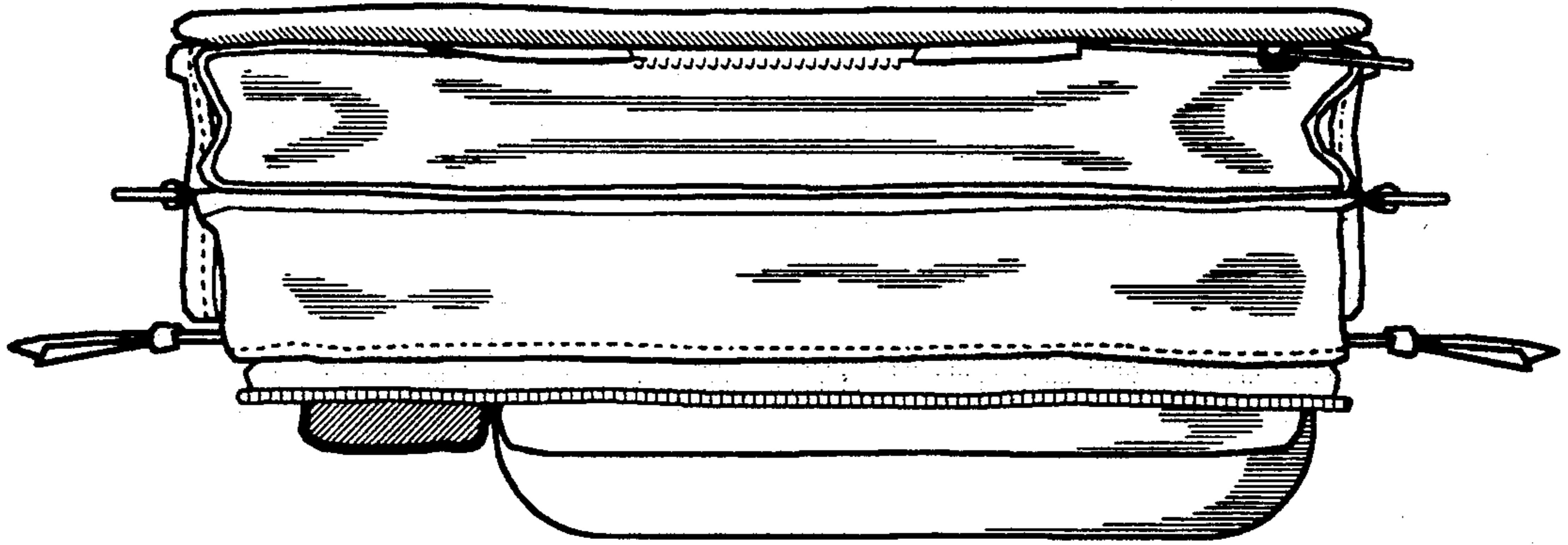

FIG. 14

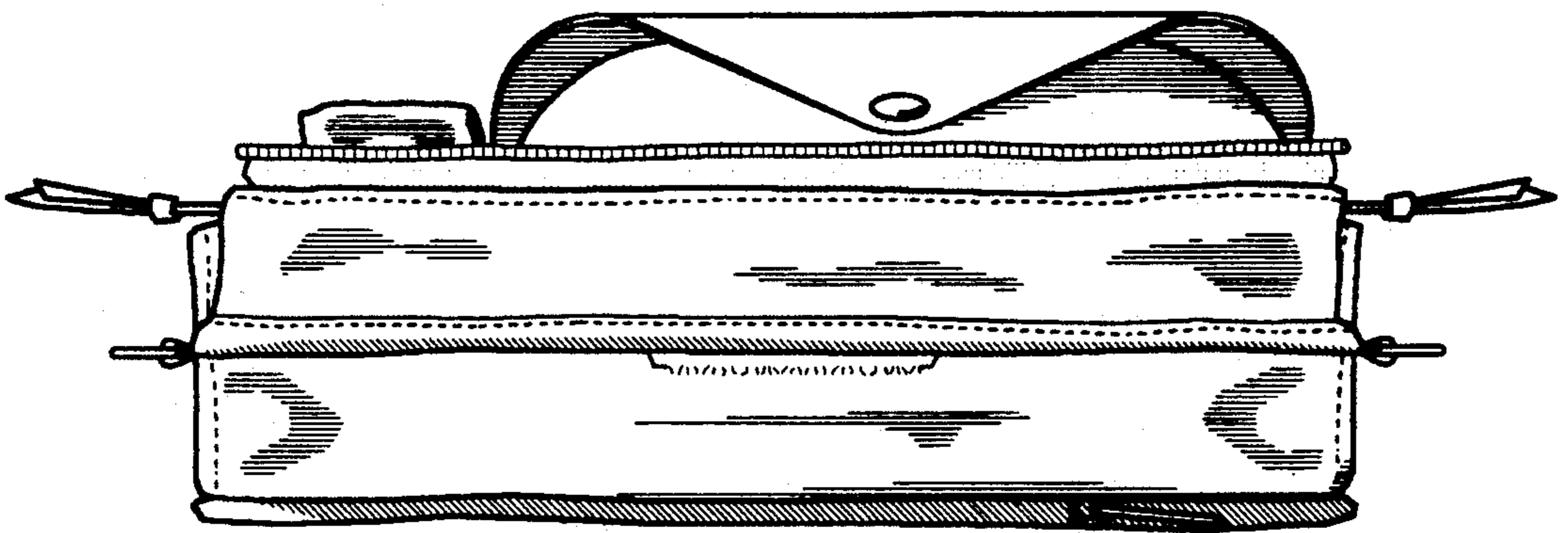

FIG. 16

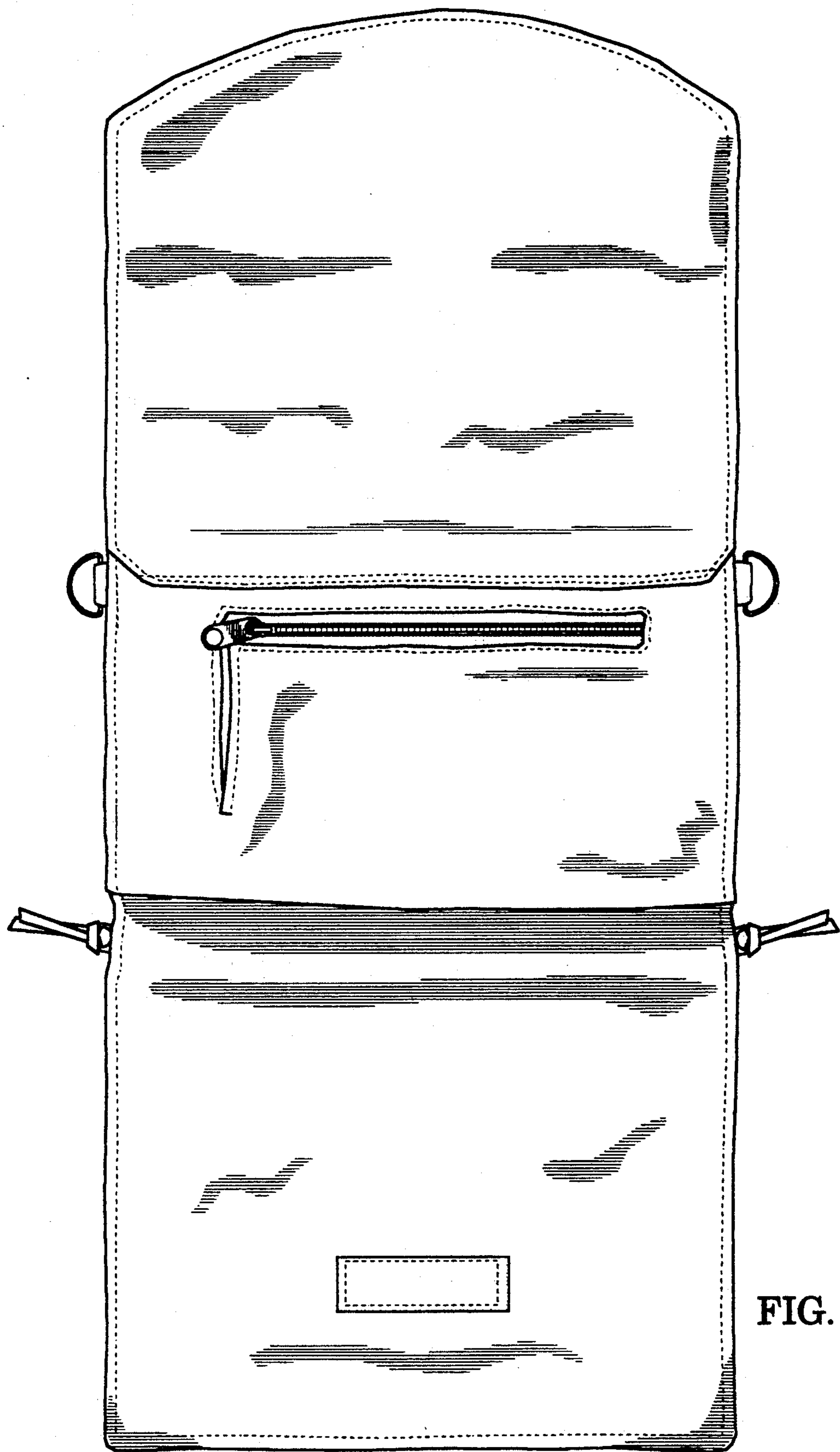

FIG. 15

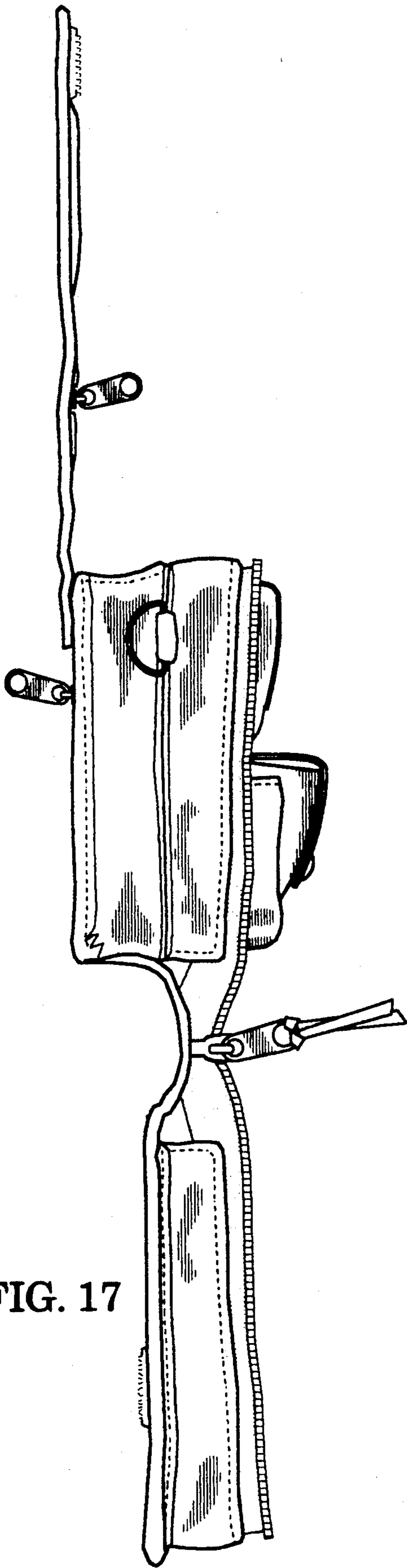

FIG. 17

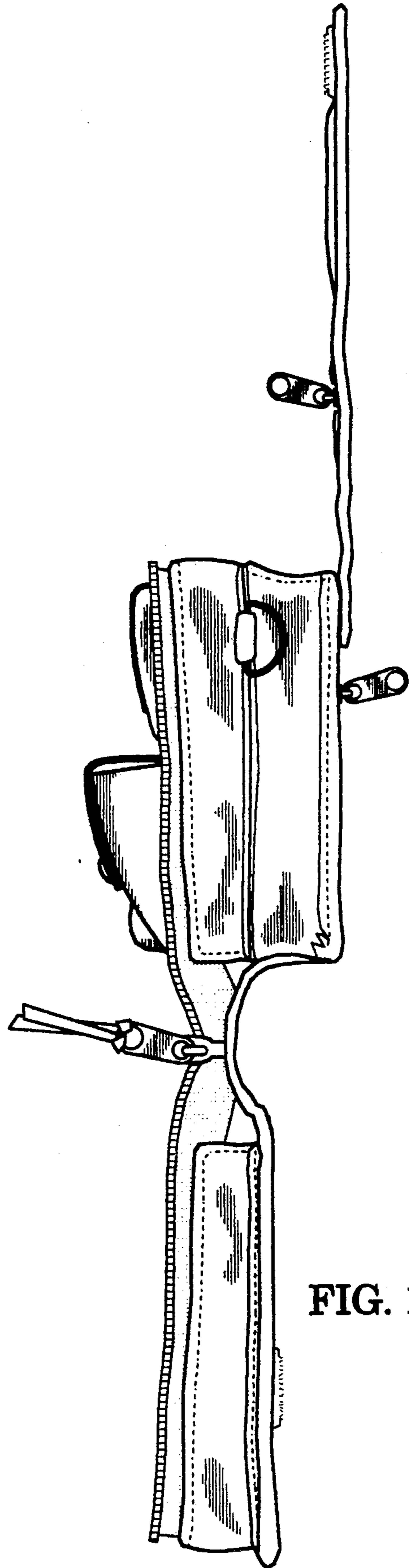

FIG. 18