



US00D338332S

United States Patent [19]

[11] Patent Number: **Des. 338,332**

Ancona et al.

[45] Date of Patent: **** Aug. 17, 1993**

[54] **CASE FOR SEWING ITEMS OR PERSONAL CARE ITEMS**

[75] Inventors: **Bruce Ancona; Jane Ancona**, both of New York City, N.Y.

[73] Assignee: **M. Kamenstein, Inc.**, White Plains, N.Y.

[**] Term: **14 Years**

[21] Appl. No.: **729,089**

[22] Filed: **Jul. 16, 1991**

[52] U.S. Cl. **D3/39; D3/20**

[58] Field of Search **D3/20, 23, 25, 39; 223/106-109 A, 111; D28/38, 61, 83, 76-78; 206/235, 581, 823**

[56] **References Cited**

U.S. PATENT DOCUMENTS

- D. 134,053 10/1942 Botham D3/39
- D. 135,357 3/1943 Botham D3/39
- D. 166,127 3/1952 Rothstein D3/20

- D. 258,324 2/1981 Rader D3/39
- D. 258,470 3/1981 Chun D3/39
- D. 282,216 1/1986 Doyel D3/20
- D. 294,773 3/1988 Beaty D3/23
- D. 308,756 6/1990 Turner D3/39
- D. 325,123 4/1992 Tiramani D3/39

Primary Examiner—Louis S. Zarfes

[57] **CLAIM**

The ornamental design for a case for sewing items or personal care items, as shown and described.

DESCRIPTION

FIG. 1 is a perspective view of a case for sewing items or personal care items showing our new design; FIG. 2 is a front elevational view; FIG. 3 is a rear elevational view; FIG. 4 is a top plan view; FIG. 5 is a bottom plan view; FIG. 6 is a left side elevational view; and, FIG. 7 is a partial perspective view with the handle in upright position.

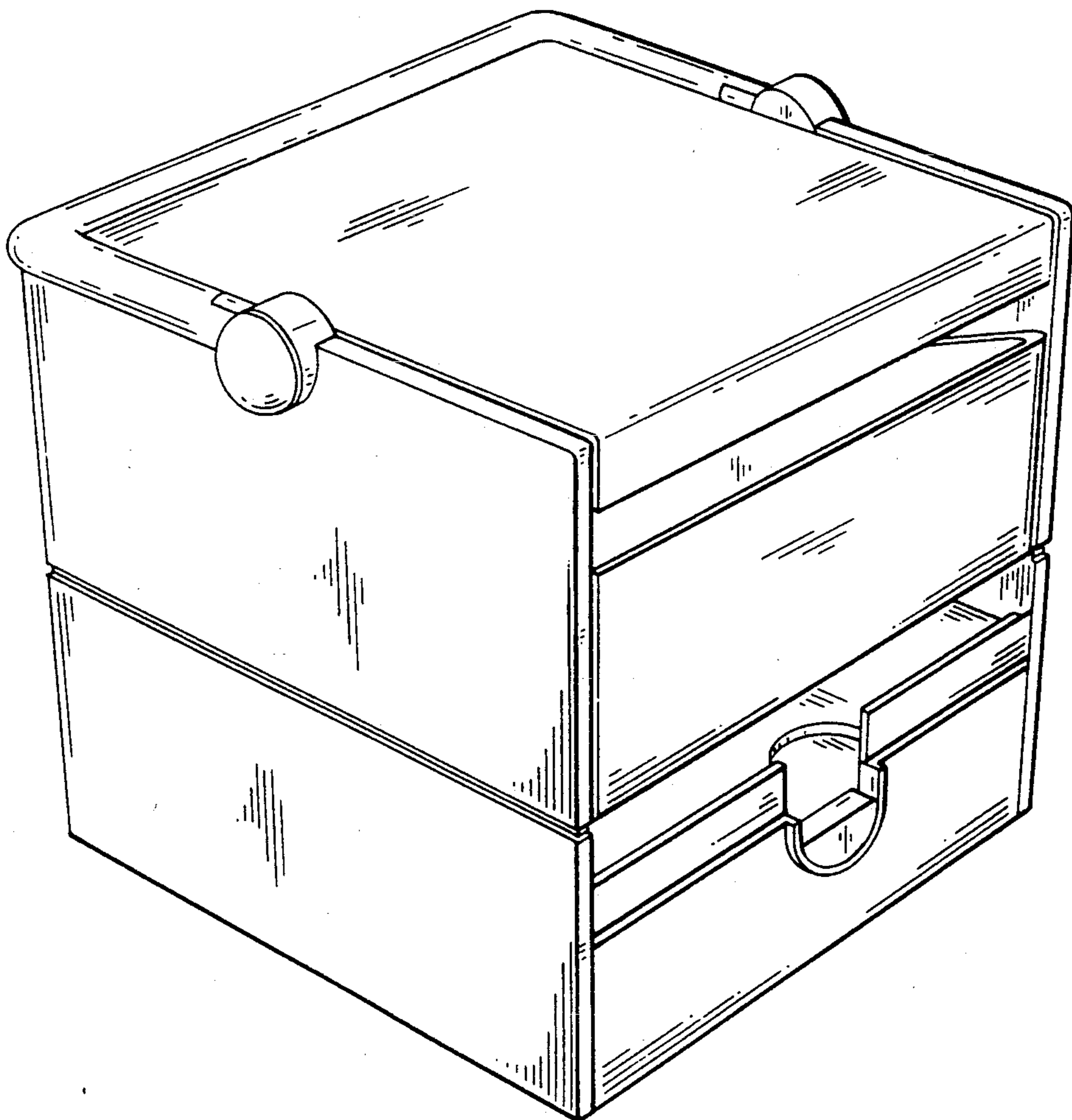

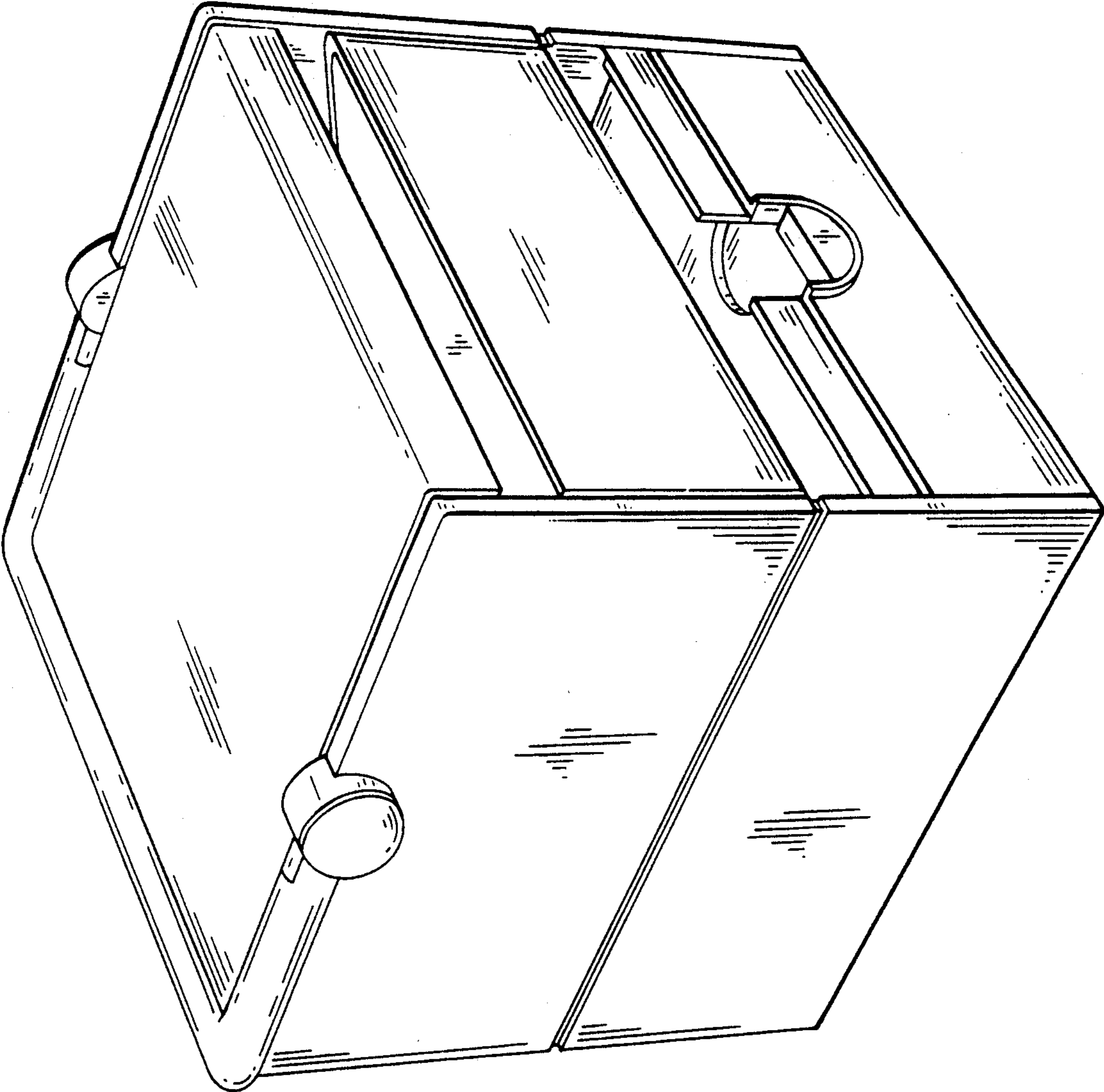

FIG. 1

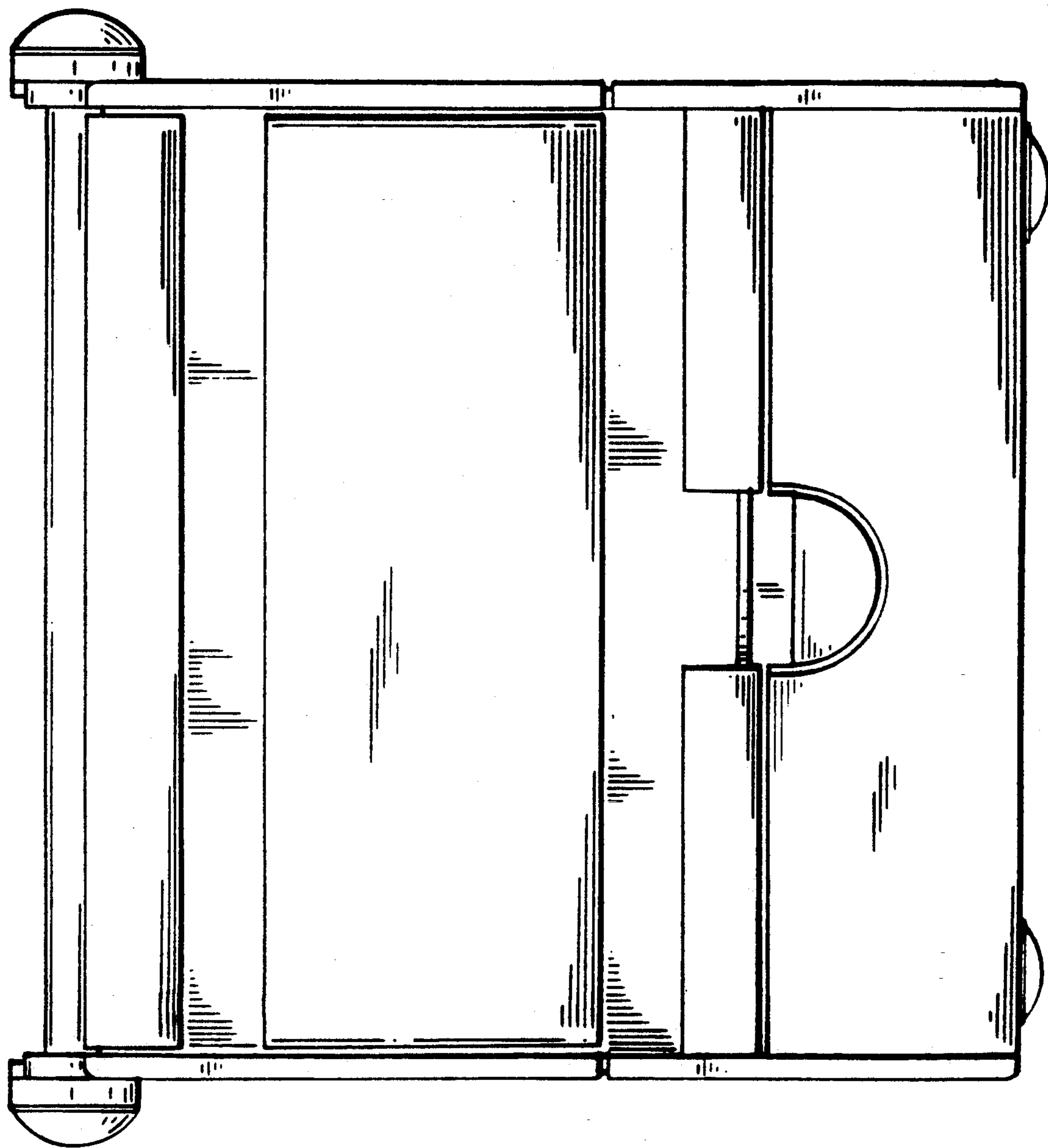

FIG. 2

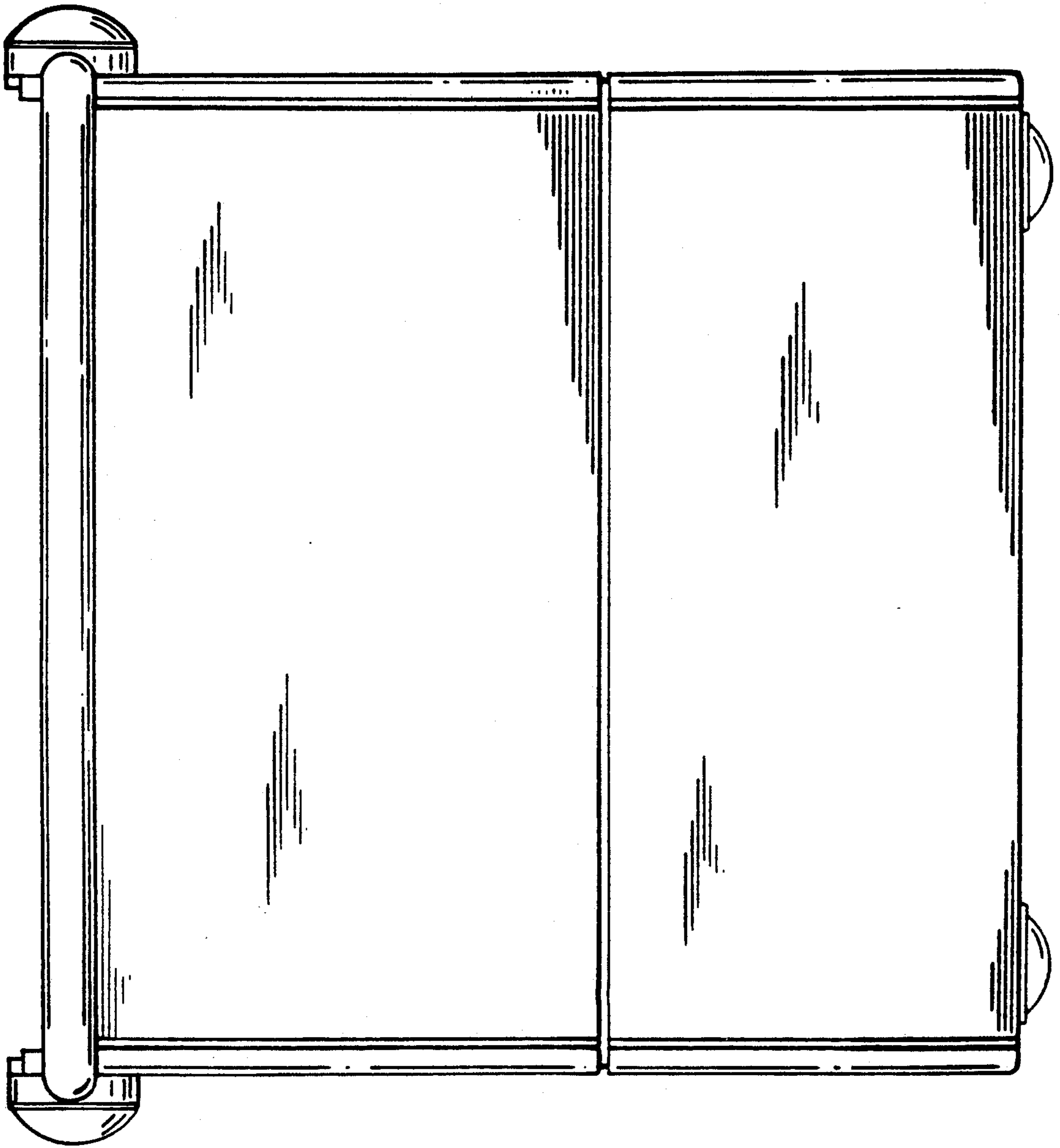

FIG. 3

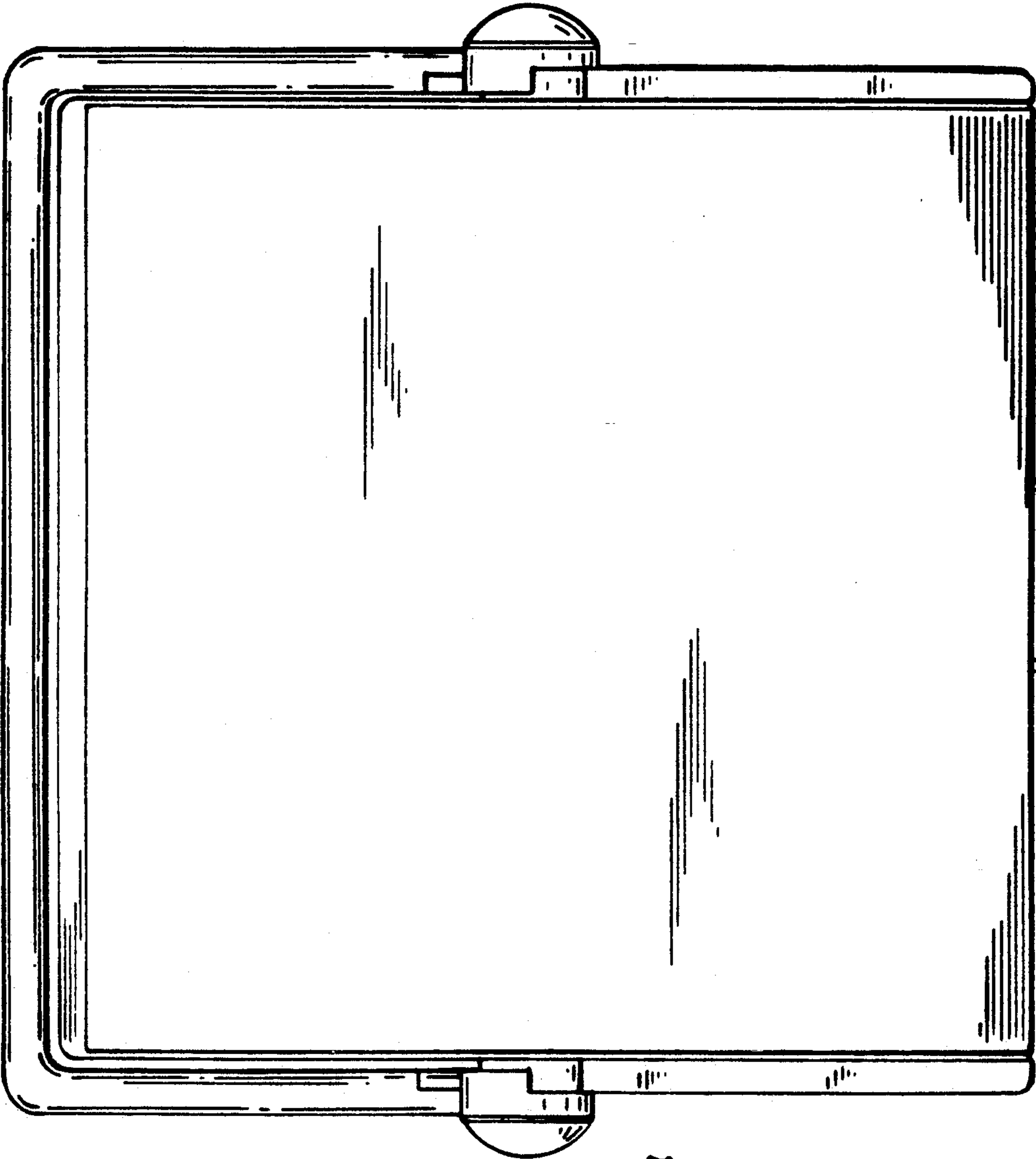
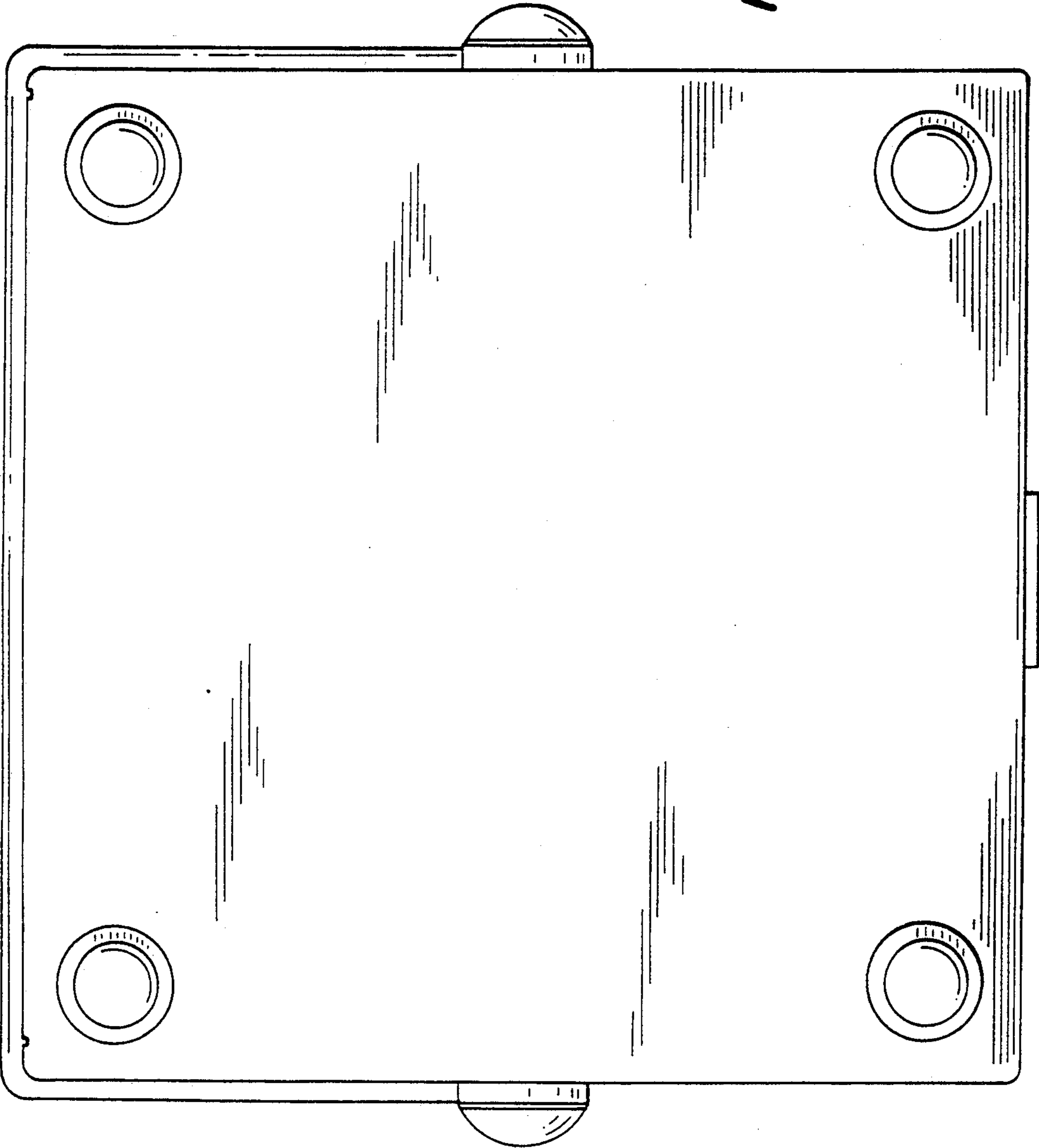

FIG. 4

FIG. 5



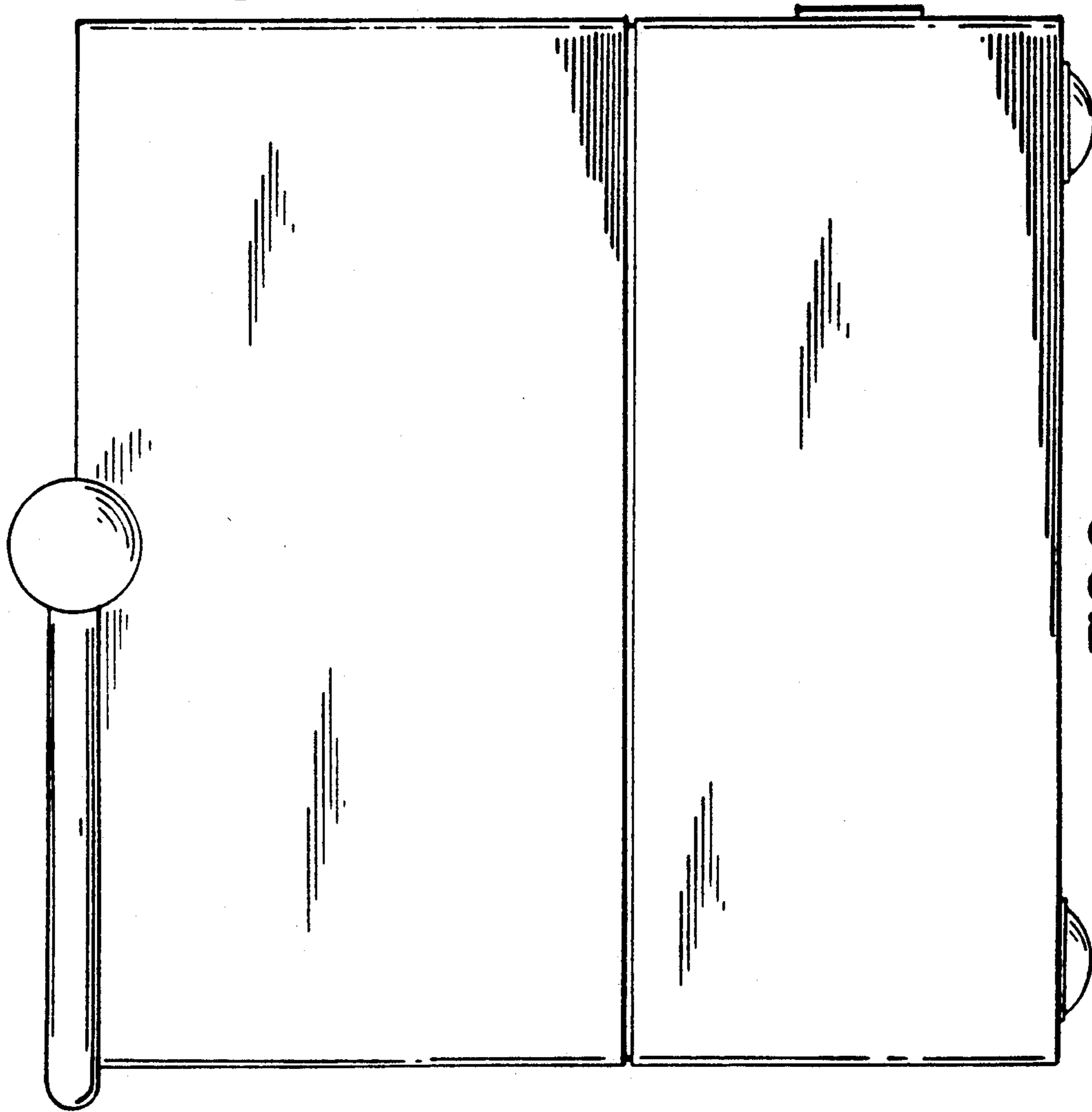

FIG. 6

