



US00D338296S

# United States Patent [19]

Yarborough

[11] Patent Number: Des. 338,296

[45] Date of Patent: \*\* Aug. 10, 1993

[54] **CLEANING PRODUCT KIT**

[76] Inventor: **Steven Yarborough**, P.O. Box 1243,  
Lady Lake, Fla. 32659

[\*\*] Term: **14 Years**

[21] Appl. No.: **553,690**

[22] Filed: **Jul. 18, 1990**

[52] U.S. Cl. .... **D32/35; D3/30.1;**  
**D3/74; D3/99**

[58] Field of Search ..... **D3/30.1, 74, 99; D32/1,**  
**D32/35, 53, 53.1; D34/1; 15/264; 134/84;**  
**220/500, 94 R**

[56] **References Cited**

**U.S. PATENT DOCUMENTS**

D. 171,199	12/1953	Edwards	.....	D34/1
D. 182,857	5/1958	Showers	.....	D32/53.1
D. 261,423	10/1981	Geissler	.....	D32/1
D. 275,618	9/1984	Agard	.....	D3/74
D. 305,515	7/1990	Robinson	.....	D32/35
D. 320,687	10/1991	Perry	.....	D32/53
D. 324,120	2/1992	Ingram et al.	.....	D34/1
D. 327,146	6/1992	Miller	.....	D32/42
3,050,766	8/1962	Millikin	.....	15/264

3,370,787	2/1968	Lindholm et al.	.....	D34/1
3,893,607	7/1975	Jones	.	
4,248,442	2/1981	Barrett	.	
4,659,496	4/1987	Klemm et al.	.	
4,827,562	5/1989	Blase et al.	.....	15/264

**FOREIGN PATENT DOCUMENTS**

0839510	6/1960	United Kingdom	.....	220/500
---------	--------	----------------	-------	---------

*Primary Examiner*—A. Hugo Word  
*Assistant Examiner*—Celia A. Murphy  
*Attorney, Agent, or Firm*—Terry M. Gernstein

[57] **CLAIM**

The ornamental design for a cleaning product kit, as shown and described.

**DESCRIPTION**

FIG. 1 is a perspective view of the cleaning product kit embodying the design of the present invention; FIG. 2 is a front elevational view thereof; FIG. 3 is a rear elevational view thereof; FIG. 4 is a right side elevational view thereof; FIG. 5 is a left side elevational view thereof; FIG. 6 is a top plan view thereof; and, FIG. 7 is a bottom plan view thereof.

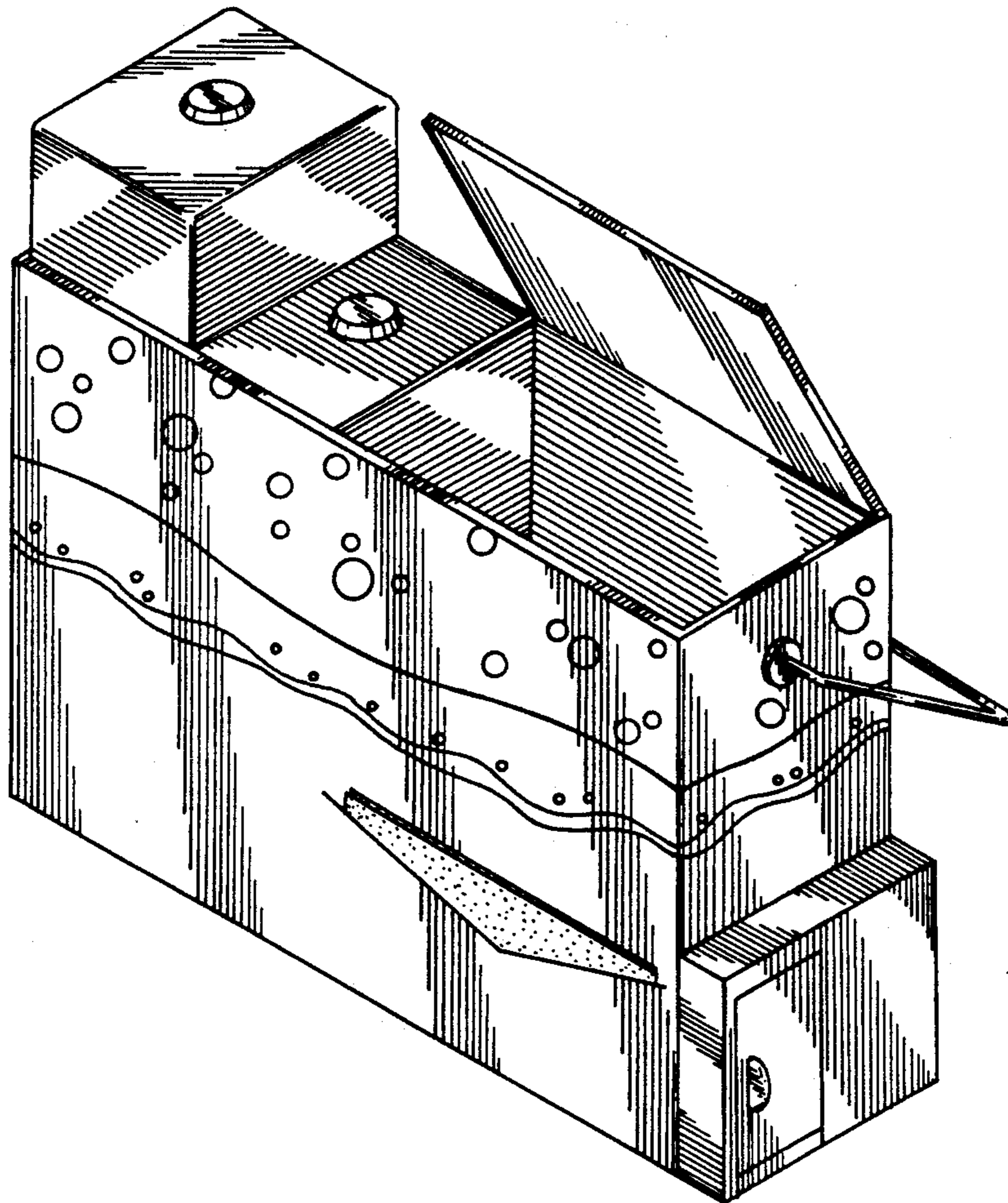

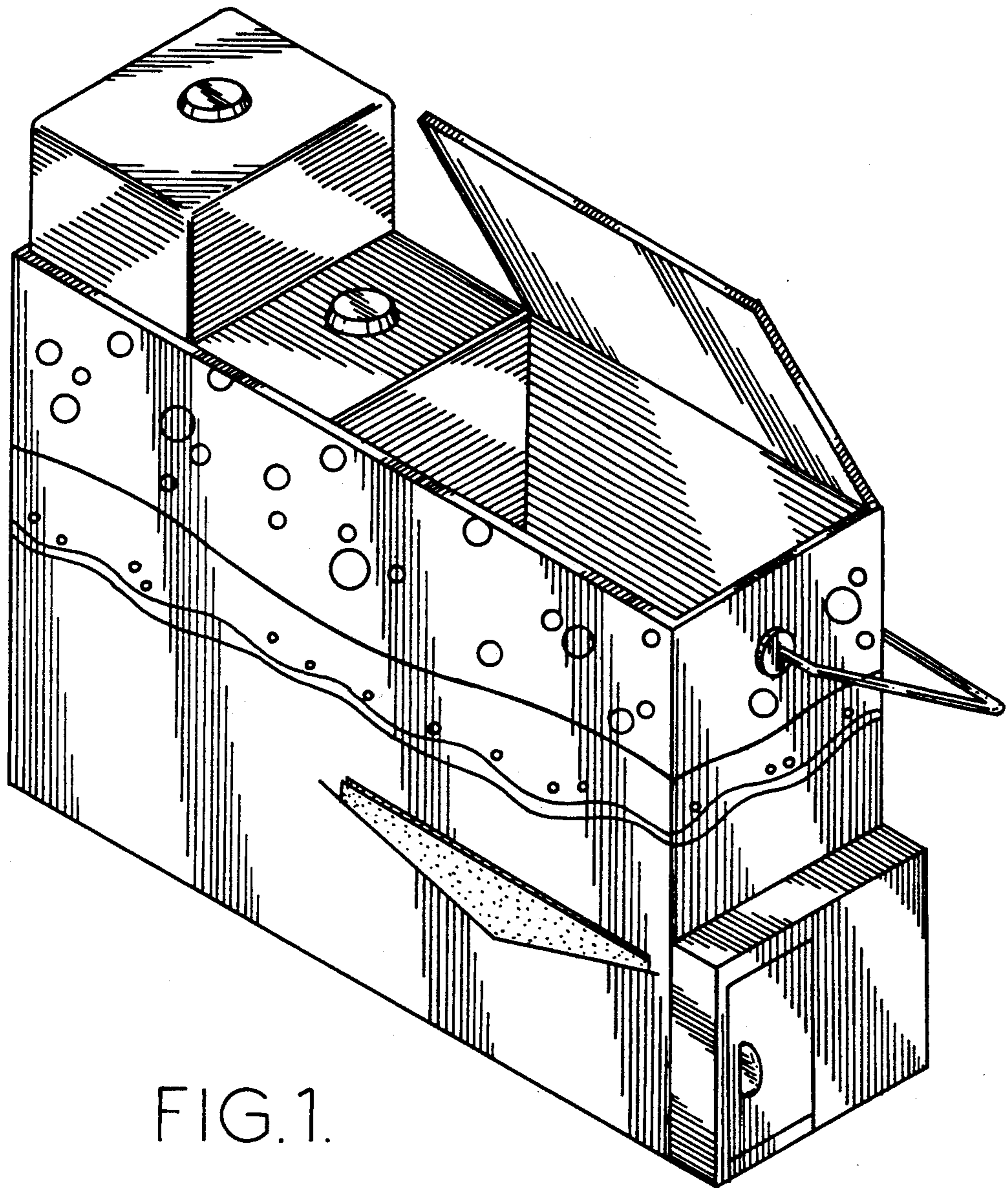

FIG.1.



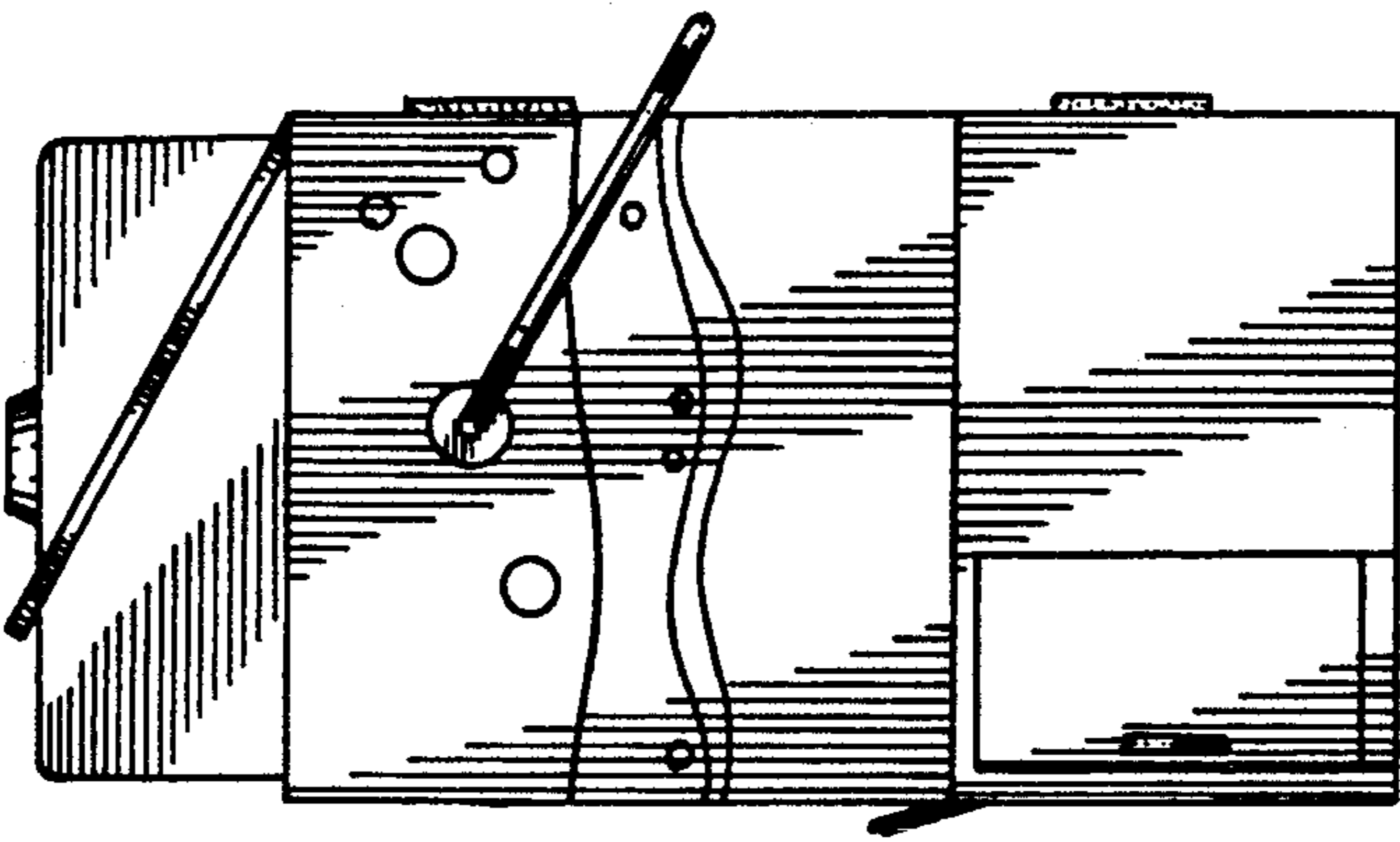

FIG. 4.

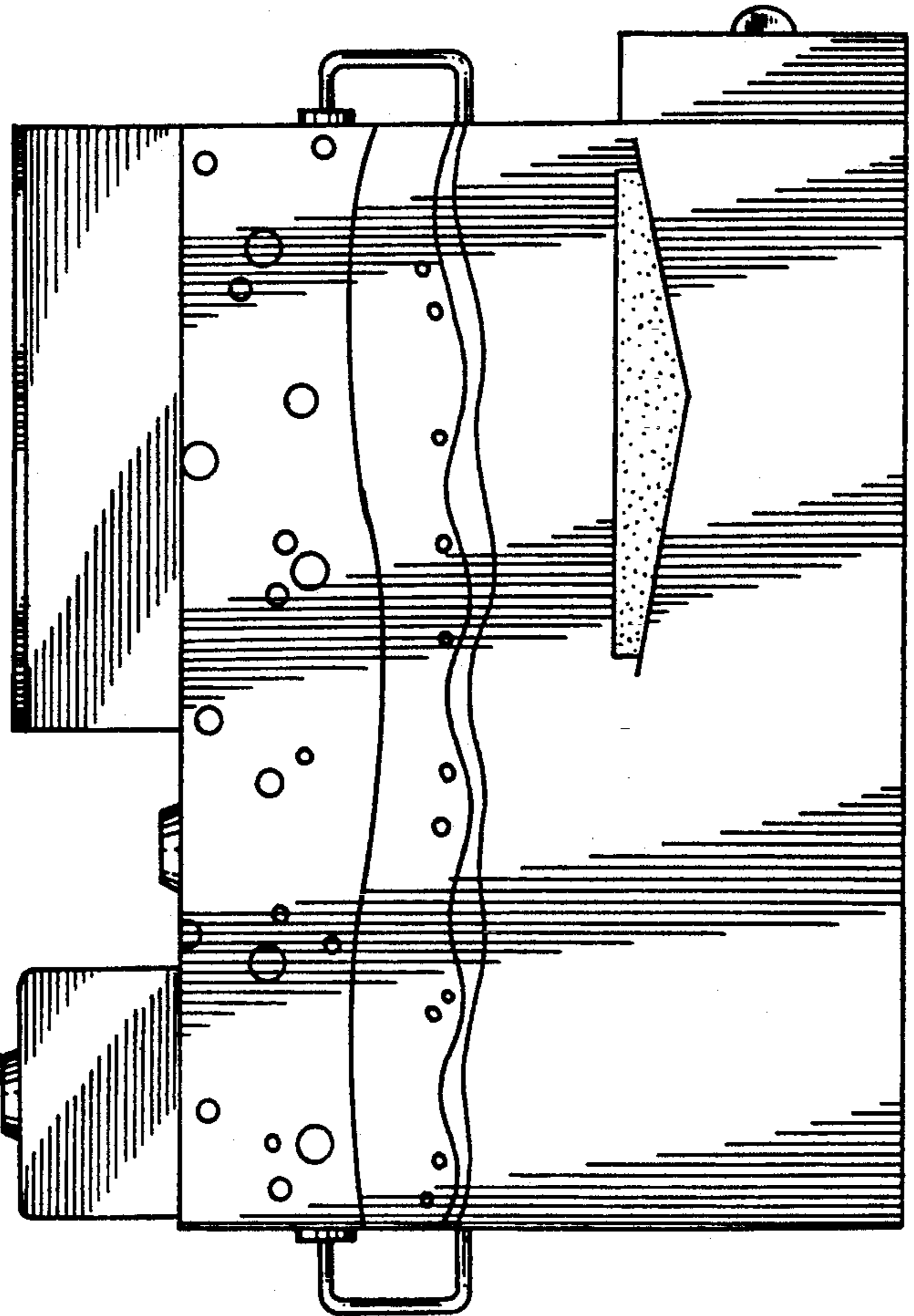

FIG. 2.

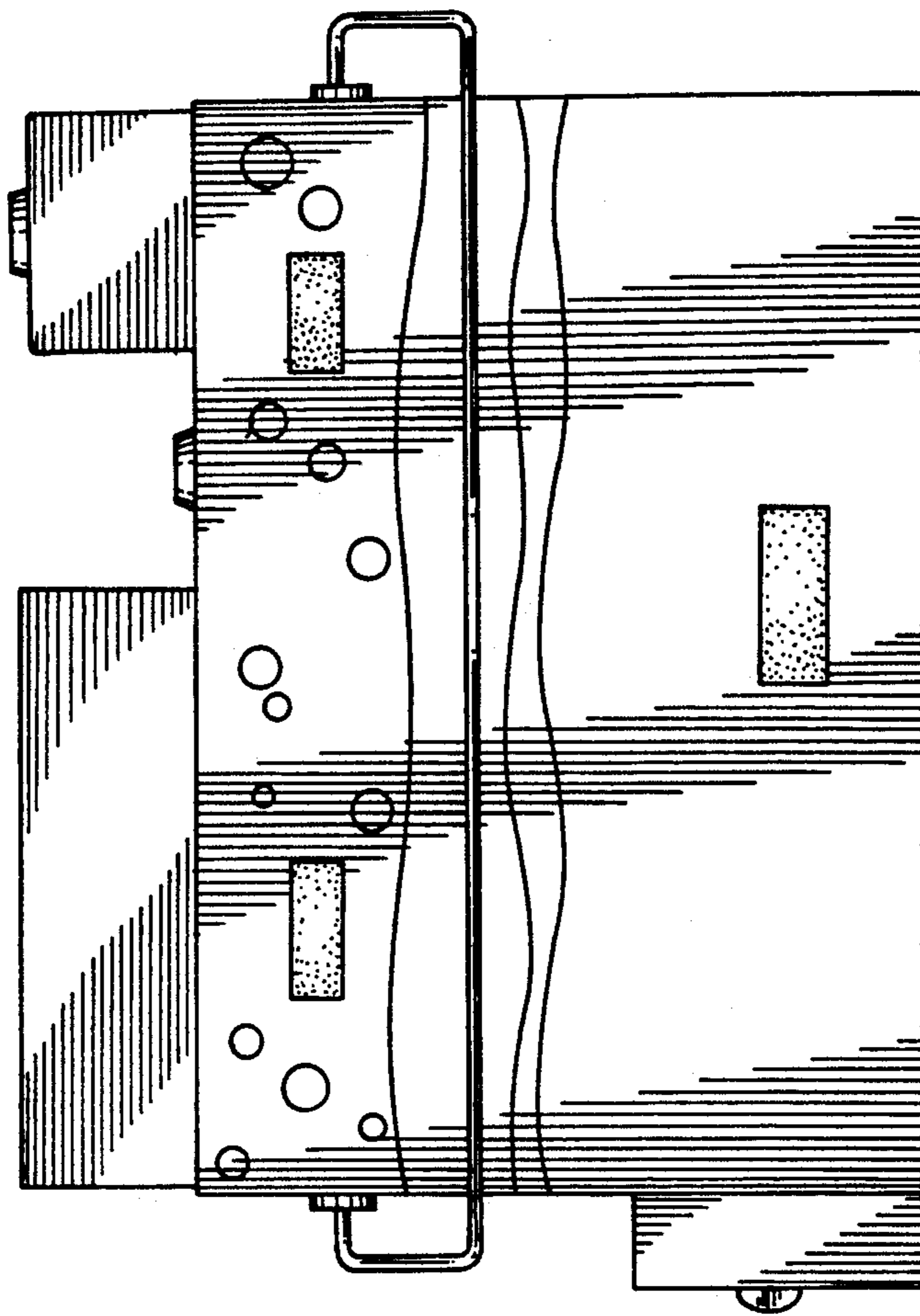

FIG. 3.

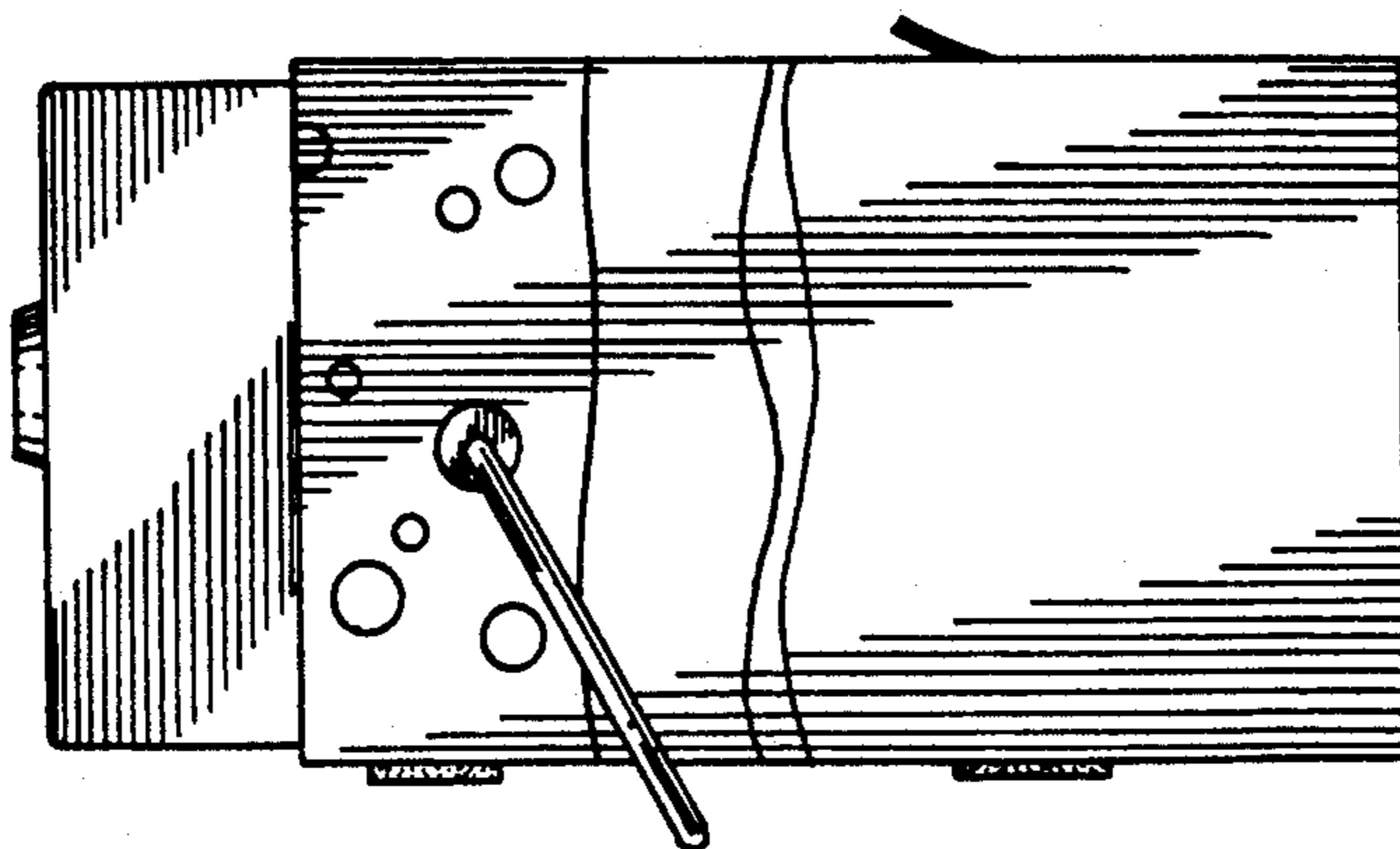

FIG. 5.

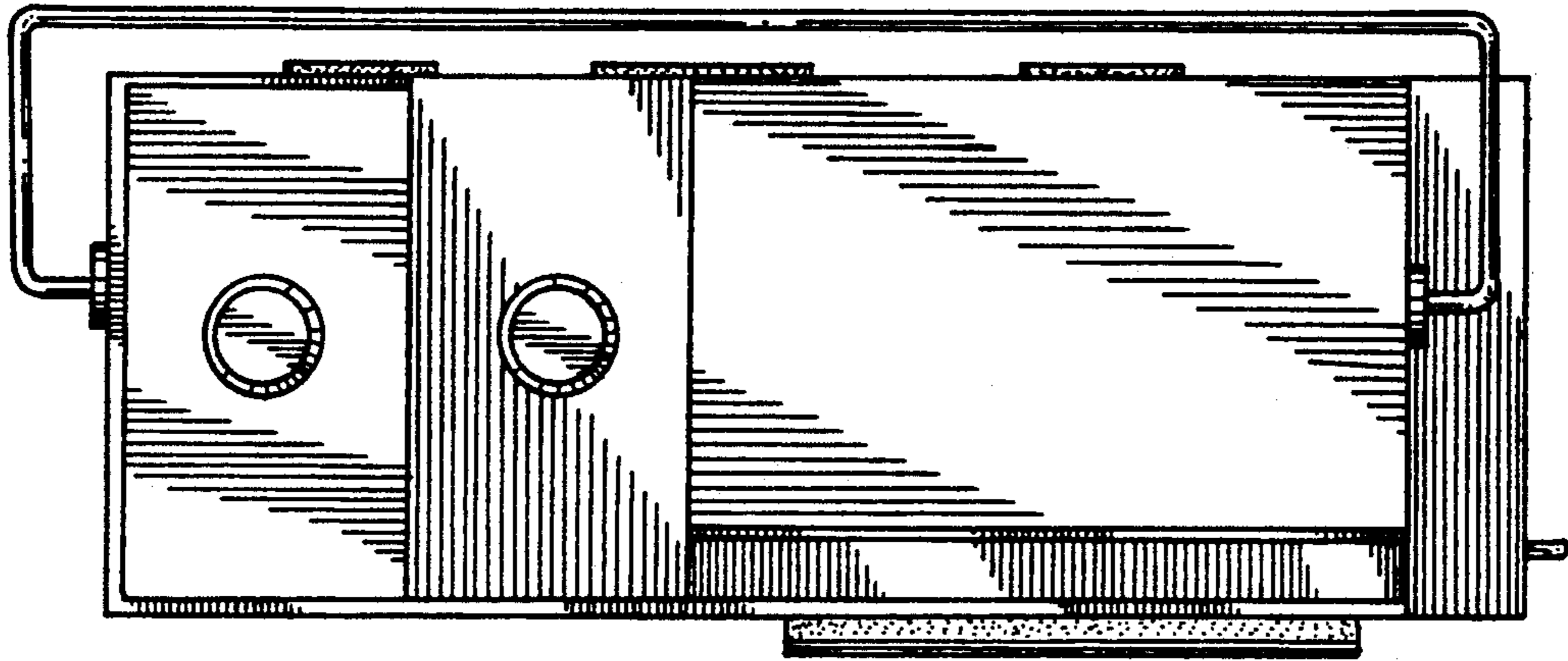

FIG. 6.

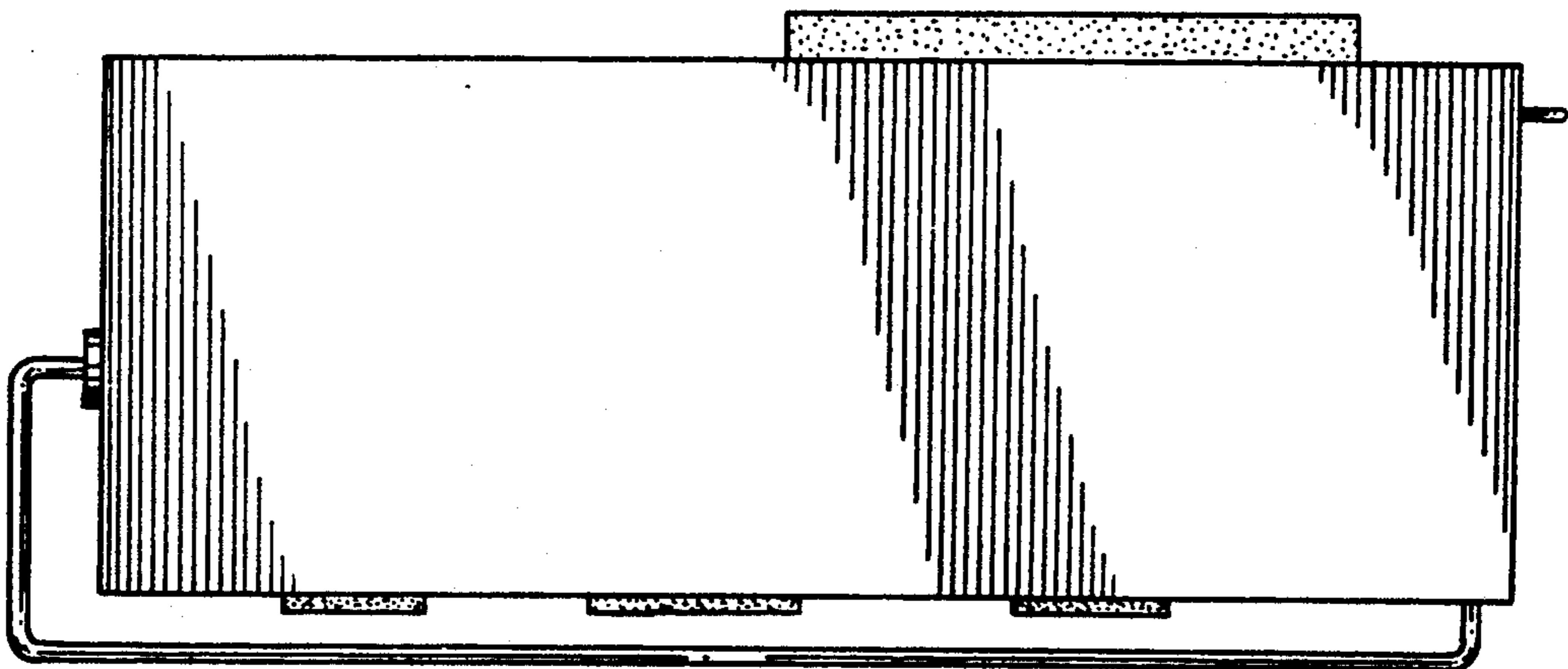

FIG. 7.