



US00D338286S

United States Patent [19]

[11] Patent Number: **Des. 338,286**

Jaramillo

[45] Date of Patent: **** Aug. 10, 1993**

[54] SALT RACK

[76] Inventor: **Matt Jaramillo**, P.O. Box 625,
Rociada, N. Mex. 87742

[**] Term: **14 Years**

[21] Appl. No.: **867,913**

[22] Filed: **Apr. 13, 1992**

[52] U.S. Cl. **D30/121**

[58] Field of Search **D30/121-122,
D30/129-133; 119/60, 51.03, 61; D11/156**

[56] References Cited

U.S. PATENT DOCUMENTS

D. 271,954	12/1983	Neil	D11/156
327,070	9/1885	Crabtree	119/60
457,784	8/1891	Lapham	119/60
526,249	9/1894	Meeker	D30/133
823,806	6/1906	Overfield	119/60
1,545,007	7/1925	Milliken	119/51.03
1,553,834	9/1925	Peterson	119/60
2,142,825	1/1939	Patten	119/51.03
3,259,106	7/1966	Ray et al.	119/51.03
5,000,122	3/1991	Smith	119/61

FOREIGN PATENT DOCUMENTS

849689	9/1960	United Kingdom	119/60
1011021	11/1965	United Kingdom	119/60
1024591	3/1966	United Kingdom	119/60

Primary Examiner—A. Hugo Word
Assistant Examiner—Cathy Anne MacCormac
Attorney, Agent, or Firm—Leon Gilden

[57] CLAIM

The ornamental design for a salt rack, as shown and described.

DESCRIPTION

FIG. 1 is a front elevational view of the salt rack showing my new design;
FIG. 2 is a rear elevational view thereof;
FIG. 3 is a left side elevational view thereof;
FIG. 4 is a right side elevational view thereof;
FIG. 5 is a top plan view thereof;
FIG. 6 is a bottom plan view thereof; and,
FIG. 7 is an isometric view showing a use thereof.
The broken lines in FIG. 7 are for purposes of illustration only and form no part of the claimed design.

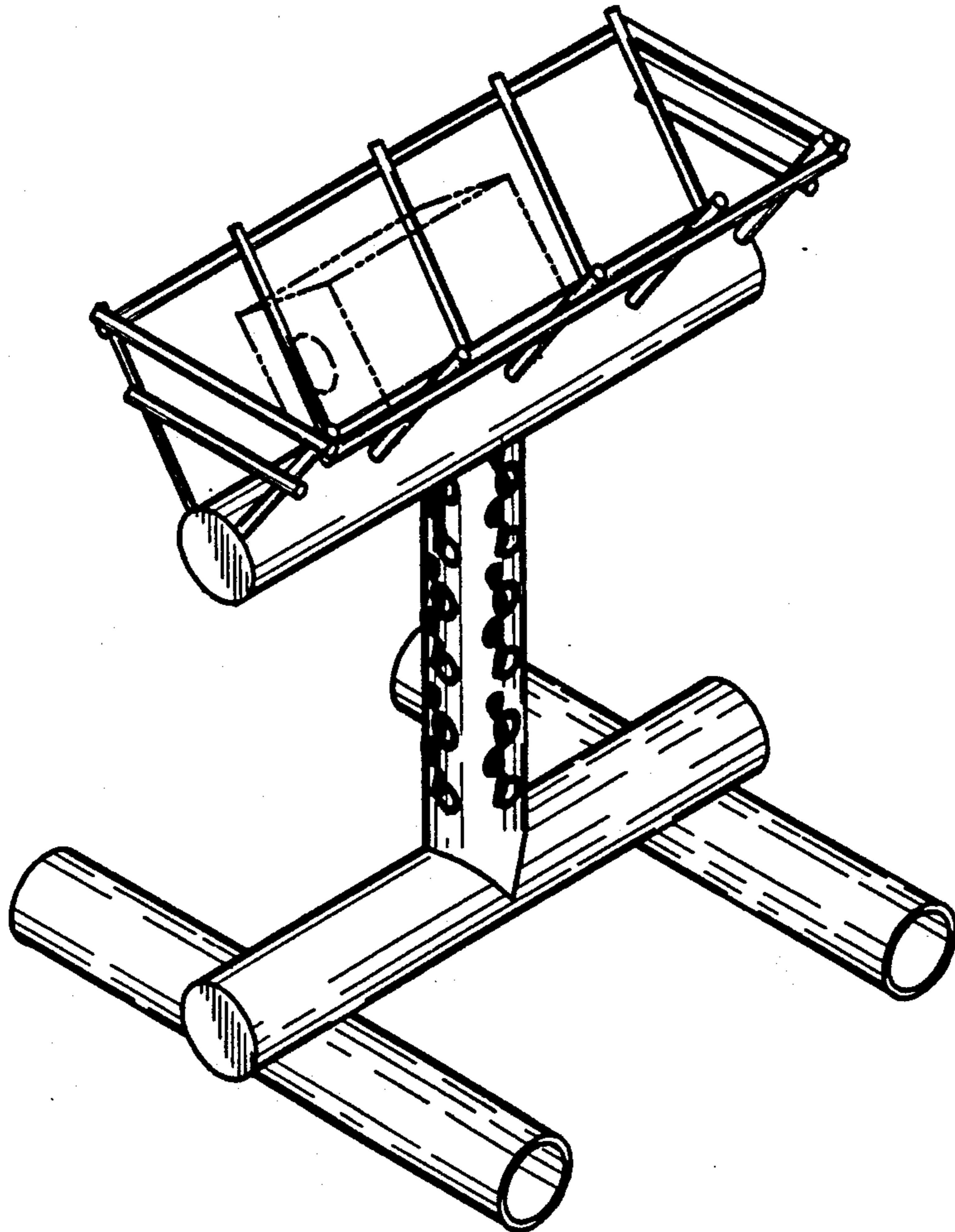

FIG. 1

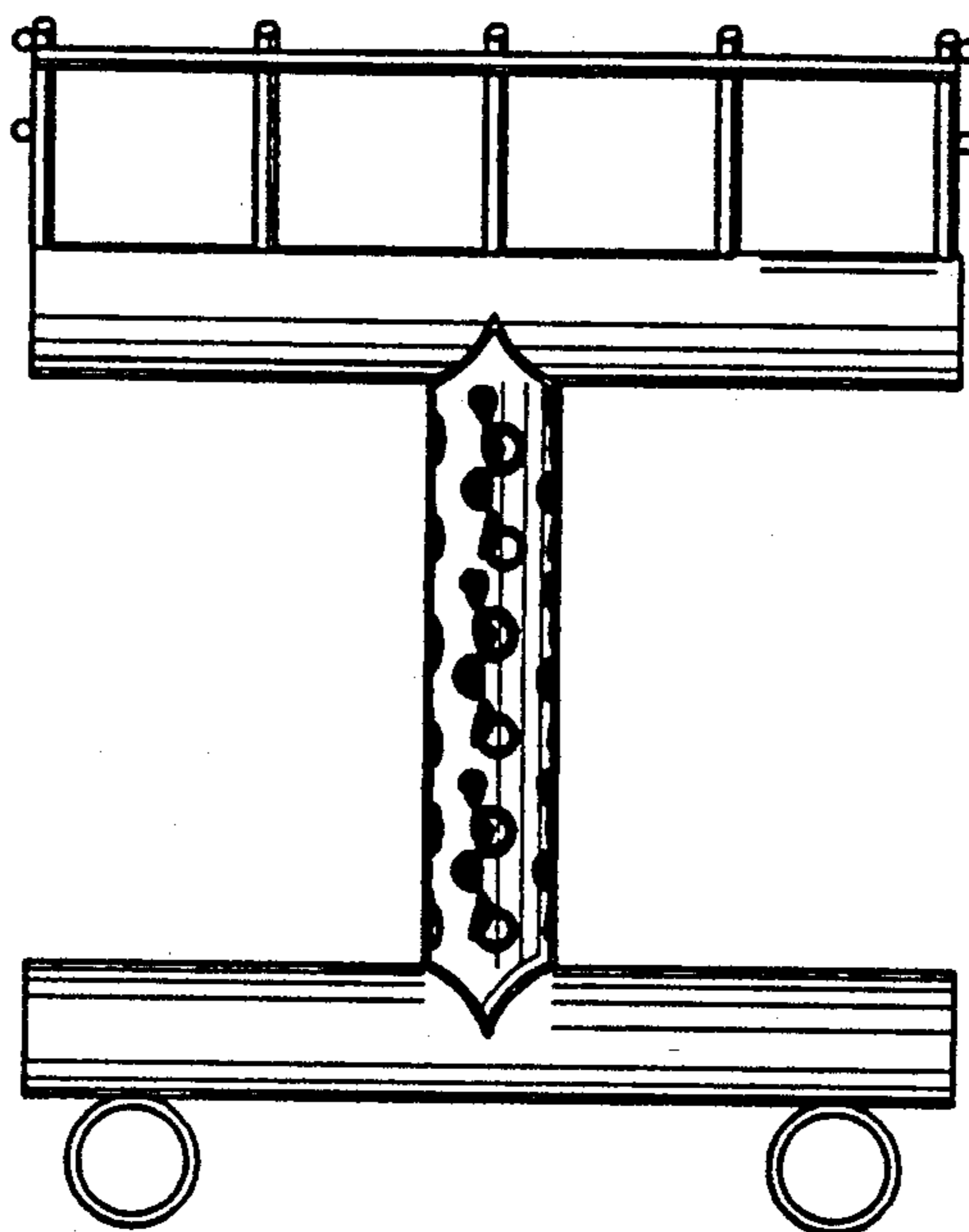

FIG. 2

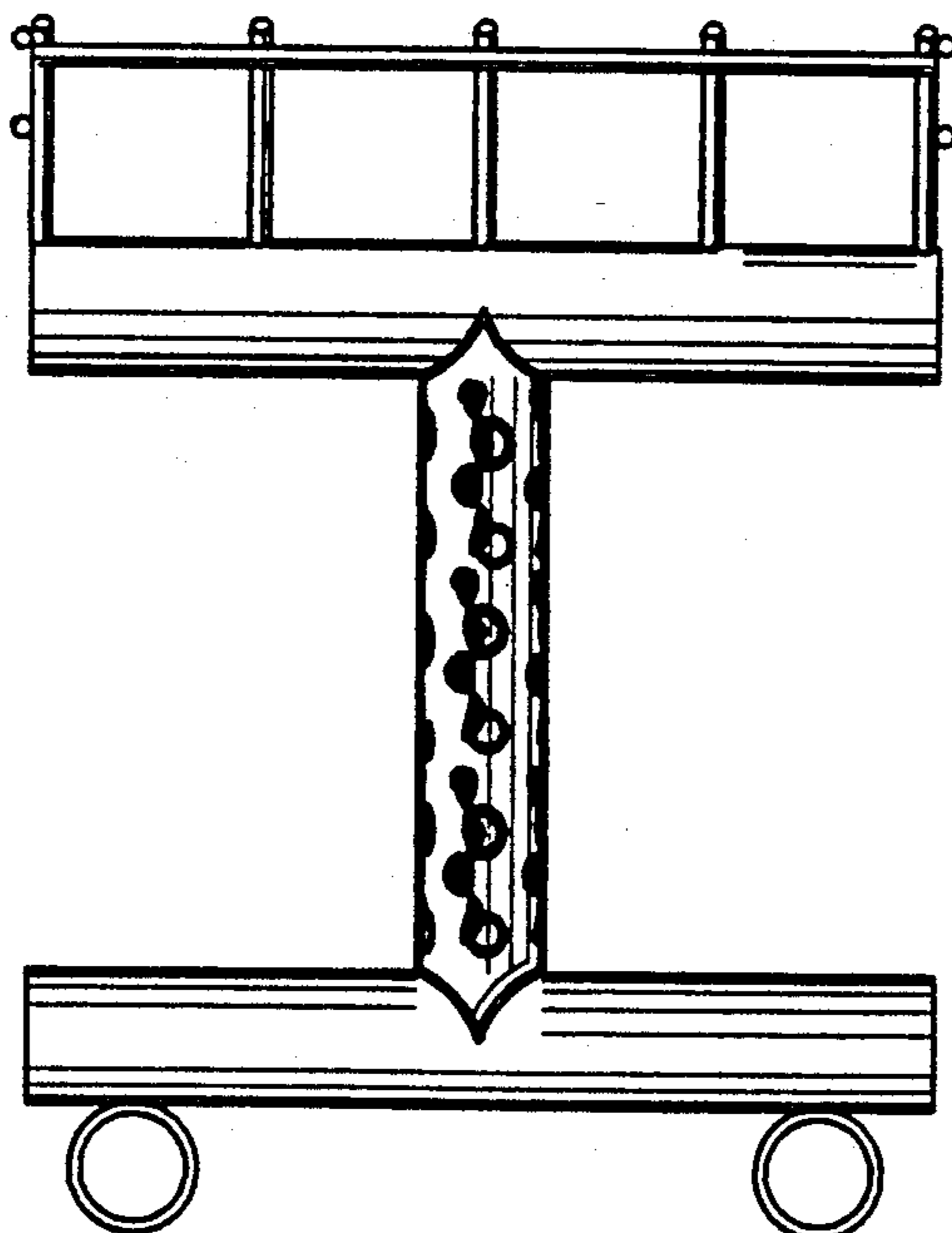

FIG. 3

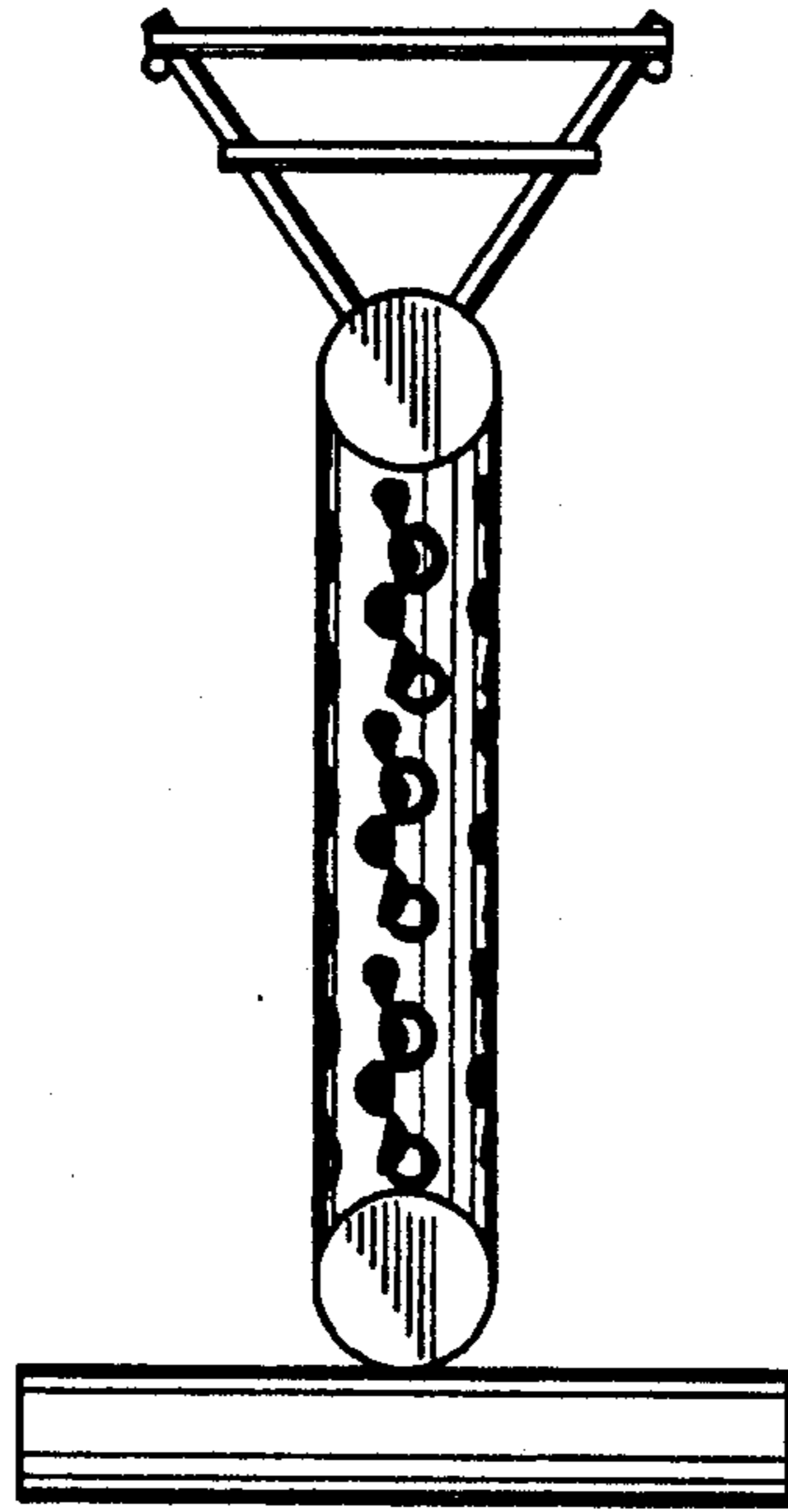

FIG. 4

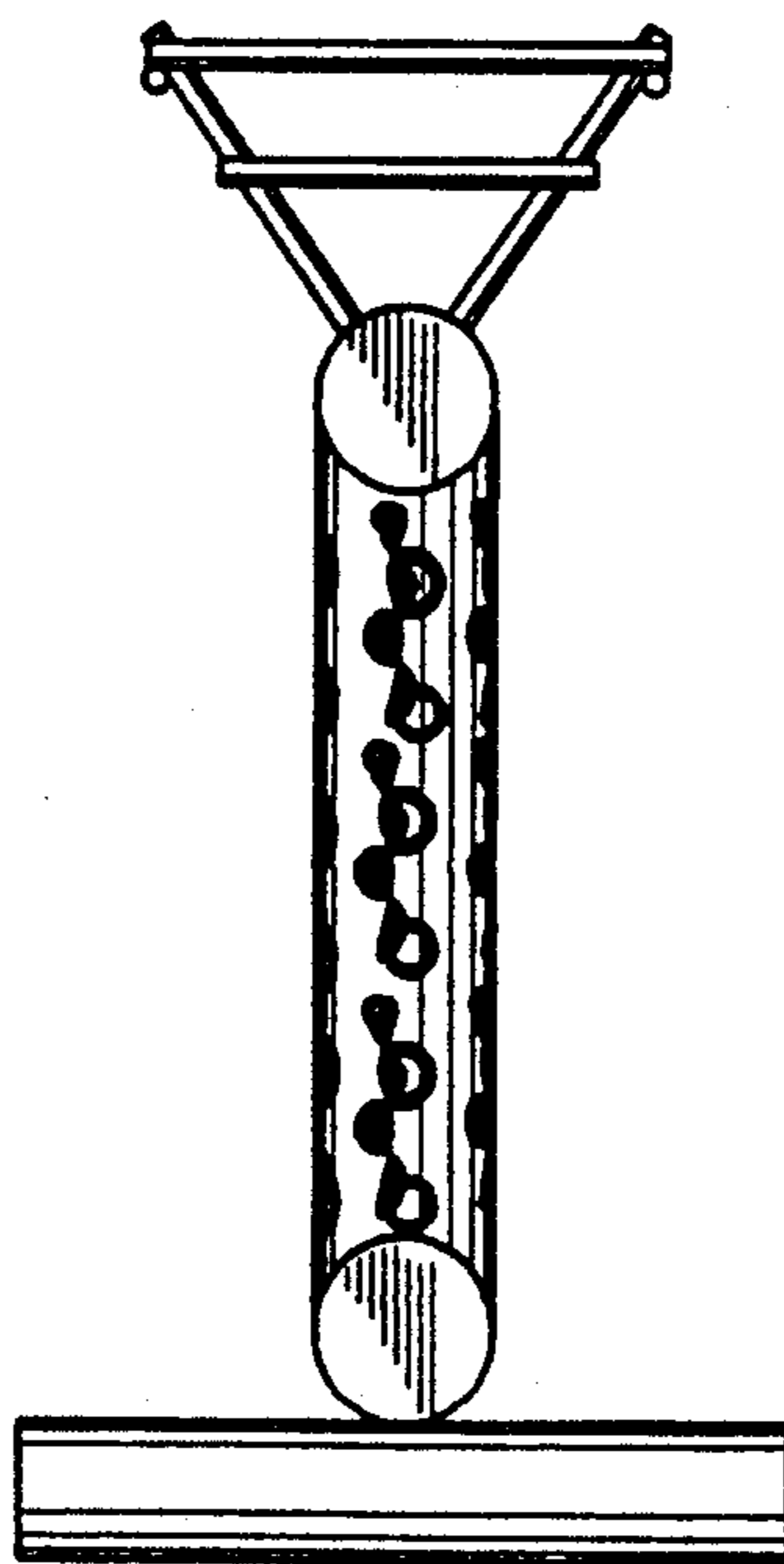

FIG. 5

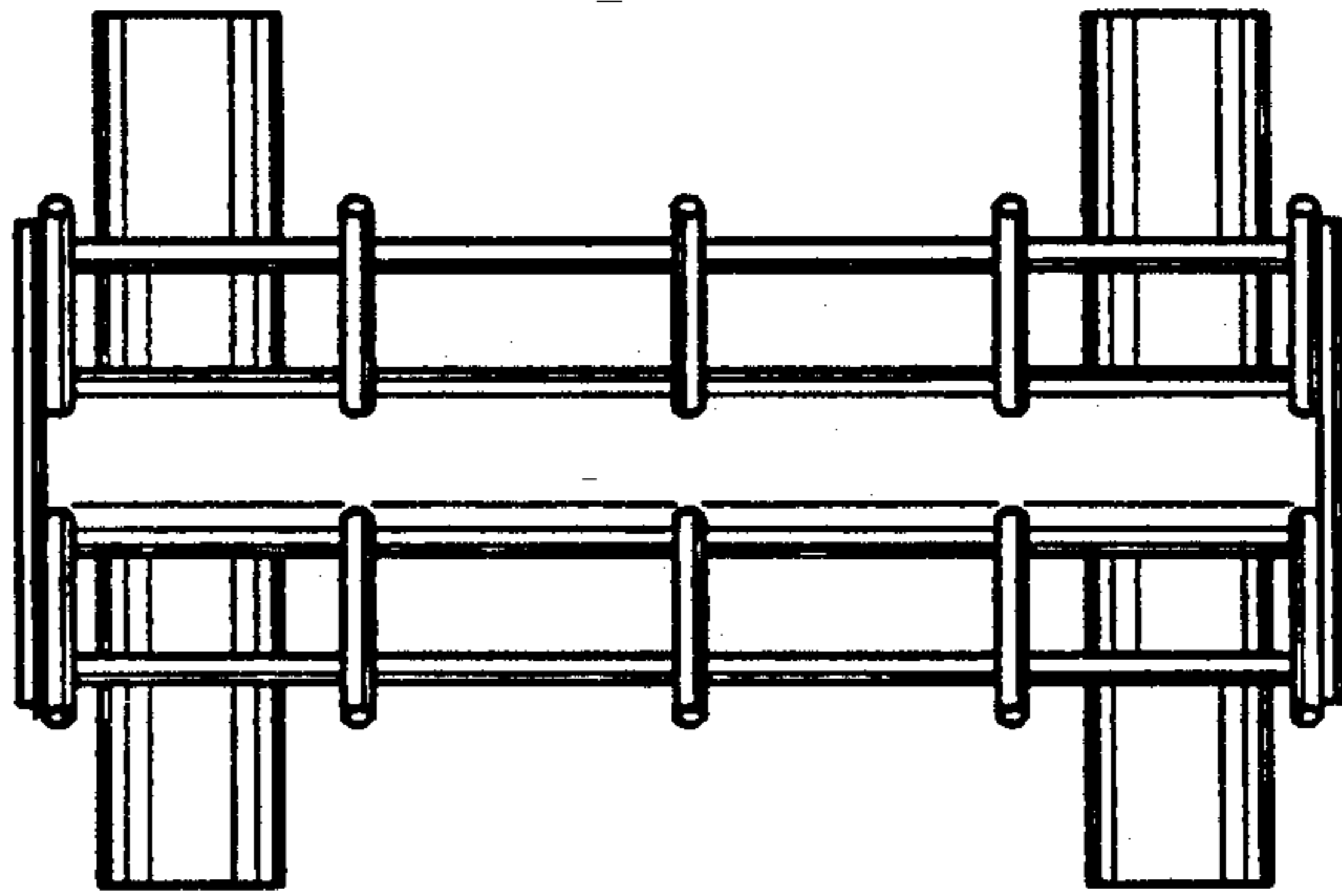

FIG. 6

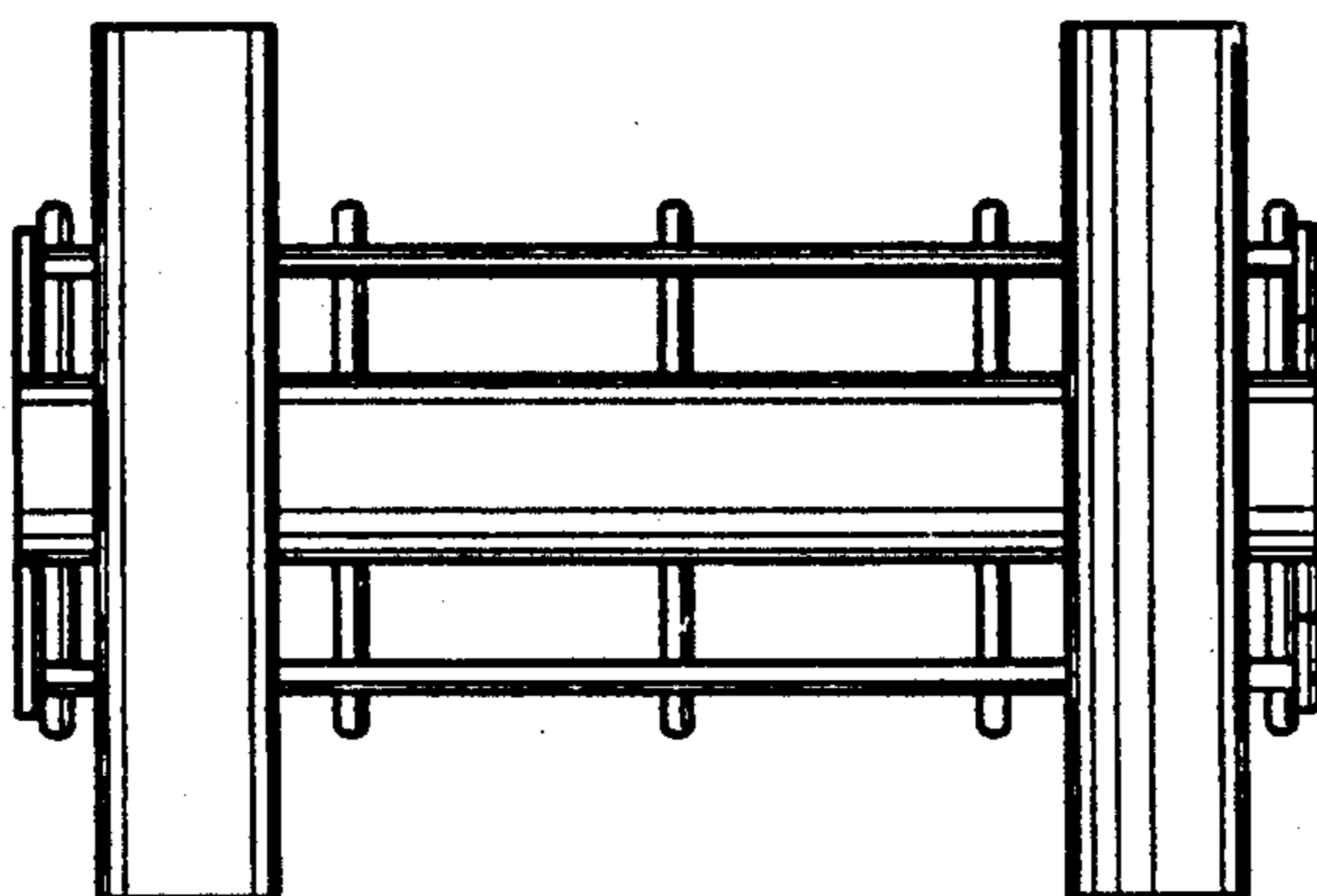

FIG. 7

