



US00D338242S

United States Patent [19]

[11] Patent Number: Des. 338,242

Cordell

[45] Date of Patent: ** Aug. 10, 1993

[54] VIDEO GAME CONTROL MODULE

[75] Inventor: John P. Cordell, Seattle, Wash.

[73] Assignee: Nintendo of America, Inc., Redmond, Wash.

[**] Term: 14 Years

[21] Appl. No.: 850,079

[22] Filed: Mar. 12, 1992

[52] U.S. Cl. D21/48

[58] Field of Search D21/48, 1; 273/148 B, 273/433-438, DIG. 28; D13/123, 133, 154, 158; D14/126, 133

[56] References Cited

U.S. PATENT DOCUMENTS

D. 247,002	1/1978	Katoh	D21/1
D. 307,921	5/1990	Barr	D21/13
D. 314,193	7/1991	Ishihara et al.	D14/114
4,401,304	8/1983	Hamano	273/433 X
4,494,755	1/1985	Caillouet, Jr.	273/DIG. 28 X
4,924,216	5/1990	Leung	273/438 X
5,046,739	9/1991	Reichow	273/148 B

OTHER PUBLICATIONS

Playthings, Feb. 1980, p. 169 as shown.
Merchandising, Mar. 1983, p. 53, Common Control #5200.
Sketch and photographs originating from Nintendo Co., Ltd.

Primary Examiner—Bernard Ansher
Assistant Examiner—Prabhakar Deshmukh
Attorney, Agent, or Firm—Nixon & Vanderhye

[57] CLAIM

The ornamental design for a video game control module, as shown and described.

DESCRIPTION

FIG. 1 is a perspective view of a video game control module showing my new design;
FIG. 2 is a top plan view thereof;
FIG. 3 is a front elevational view thereof;
FIG. 4 is a right side elevational view thereof;
FIG. 5 is a rear elevational view thereof;
FIG. 6 is a left side elevational view thereof;
FIG. 7 is a bottom plan view thereof;
FIG. 8 is a perspective view of a second embodiment of FIG. 1;
FIG. 9 is a top plan view of FIG. 8;
FIG. 10 is a front elevational view of FIG. 8;
FIG. 11 is a right side elevational view of FIG. 8;
FIG. 12 is a rear elevational view of FIG. 8;
FIG. 13 is a left side elevational view of FIG. 8;
FIG. 14 is a bottom plan view of FIG. 8; and,
FIG. 15 is a reduced scale perspective view of FIG. 1 shown in its environmental use for clarity of illustration. The broken line showing of a video game machine and another video game control module is for illustrative purpose only and forms no part of the claim.

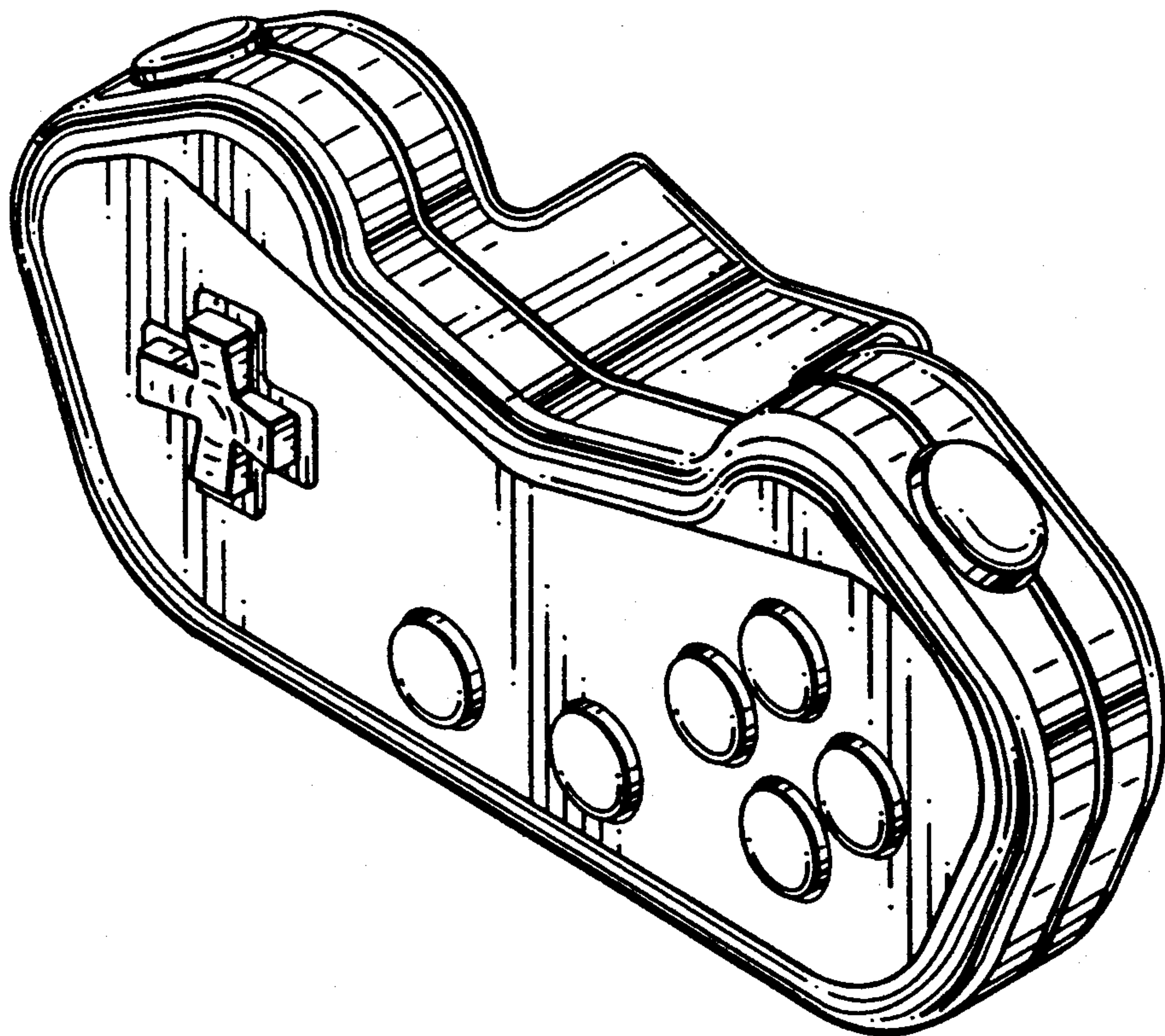

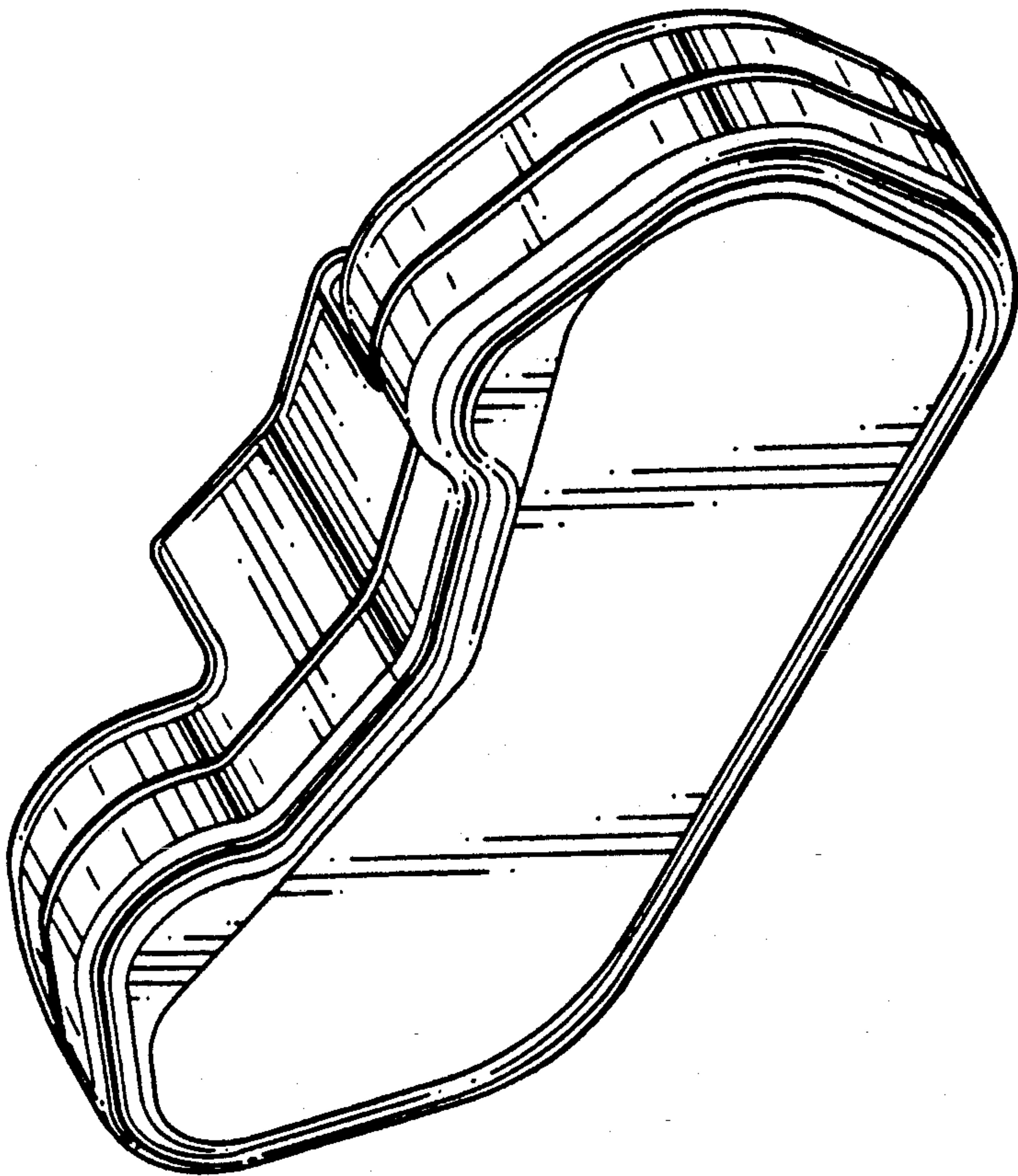

FIG. 8

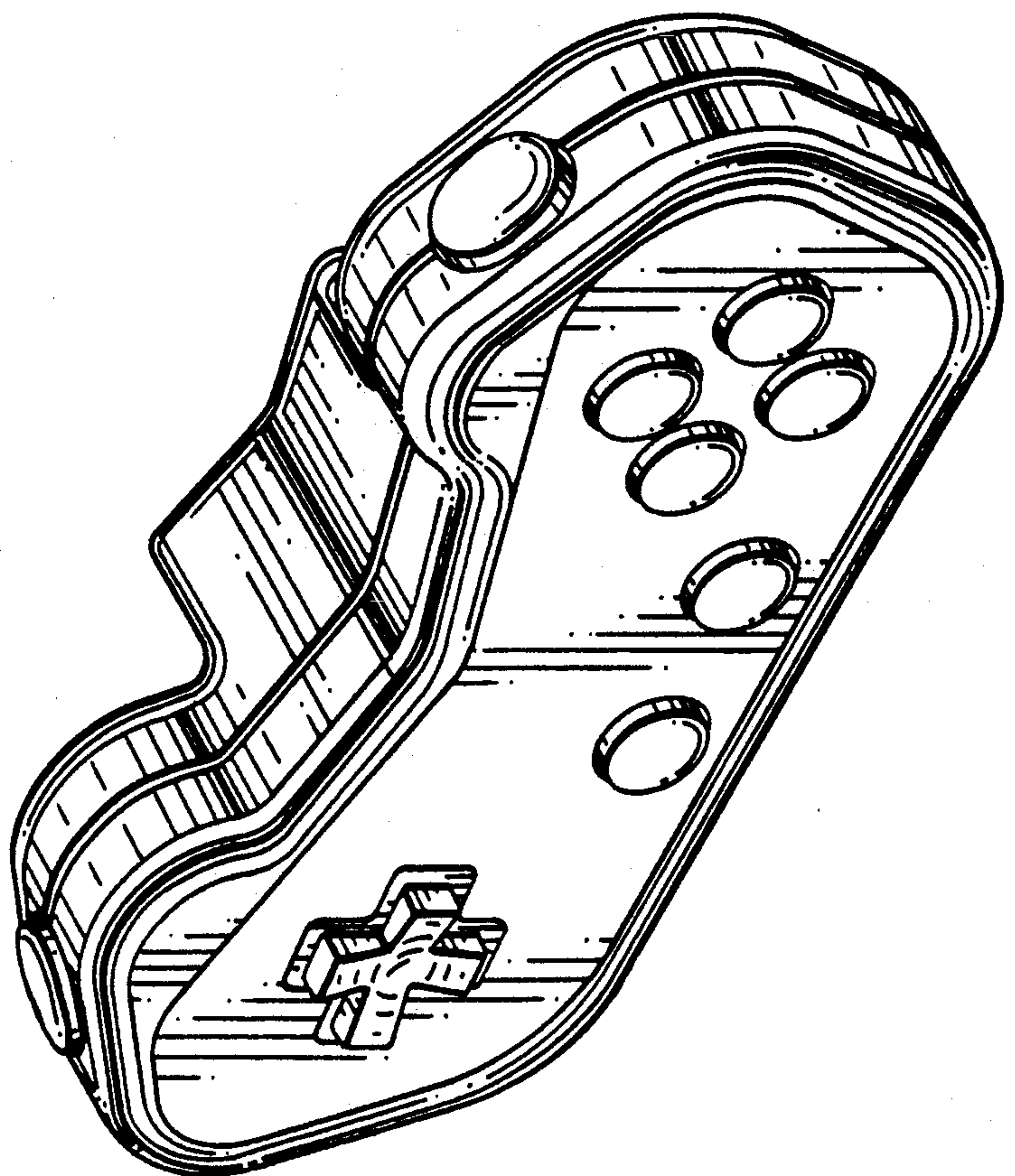

FIG. 1

FIG. 2

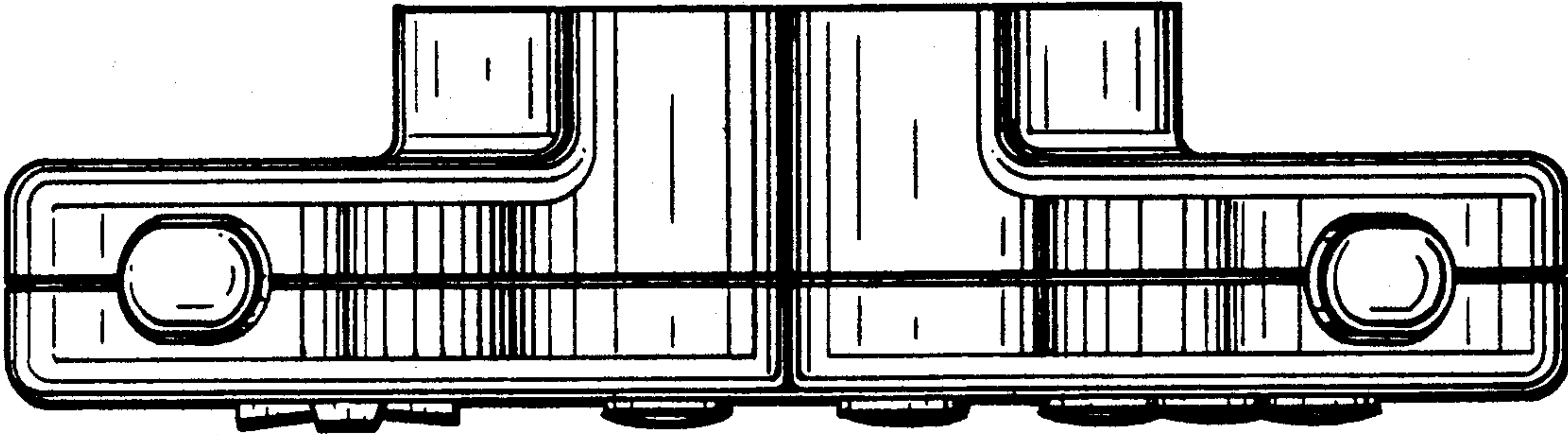

FIG. 3

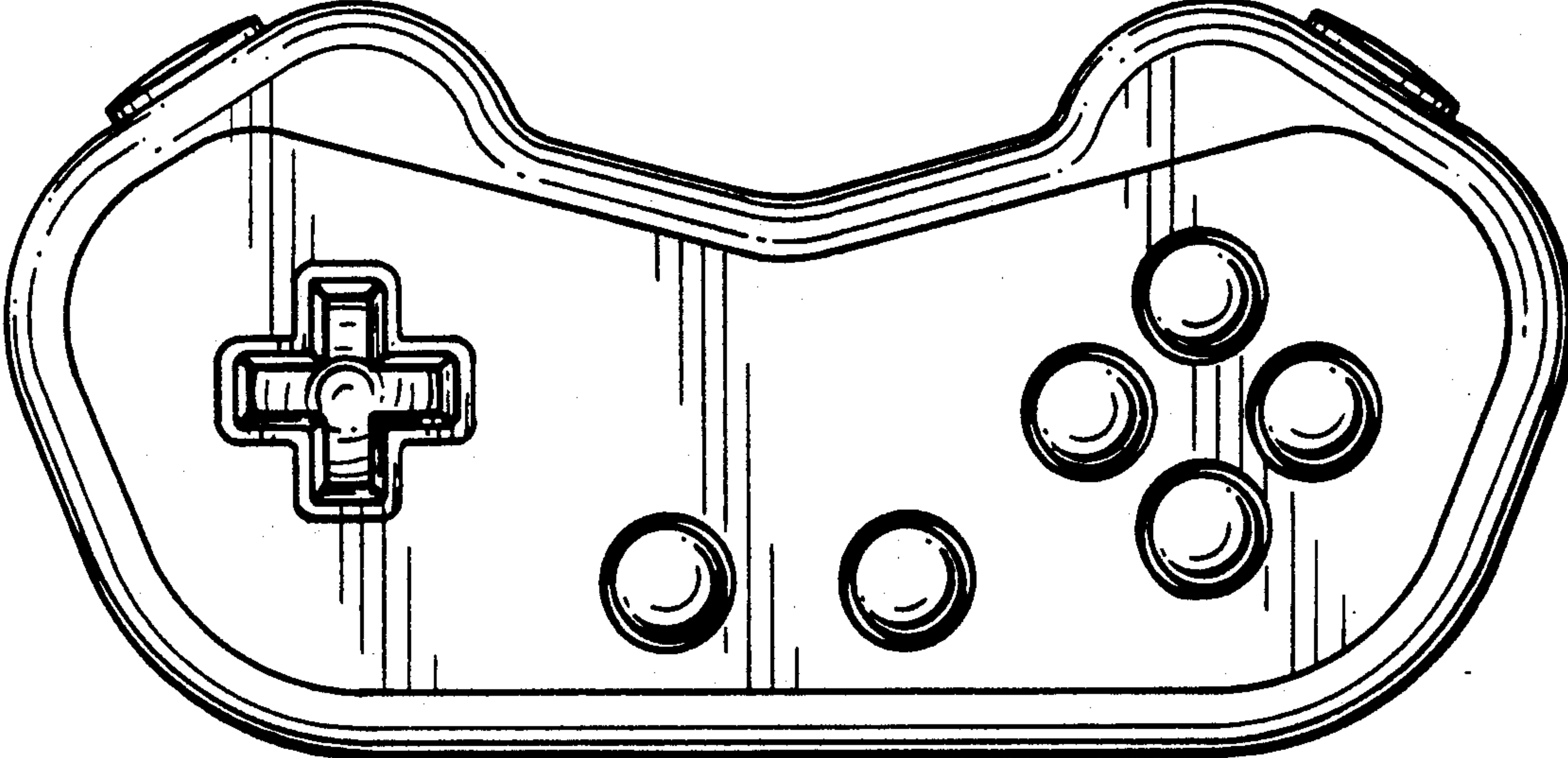

FIG. 4

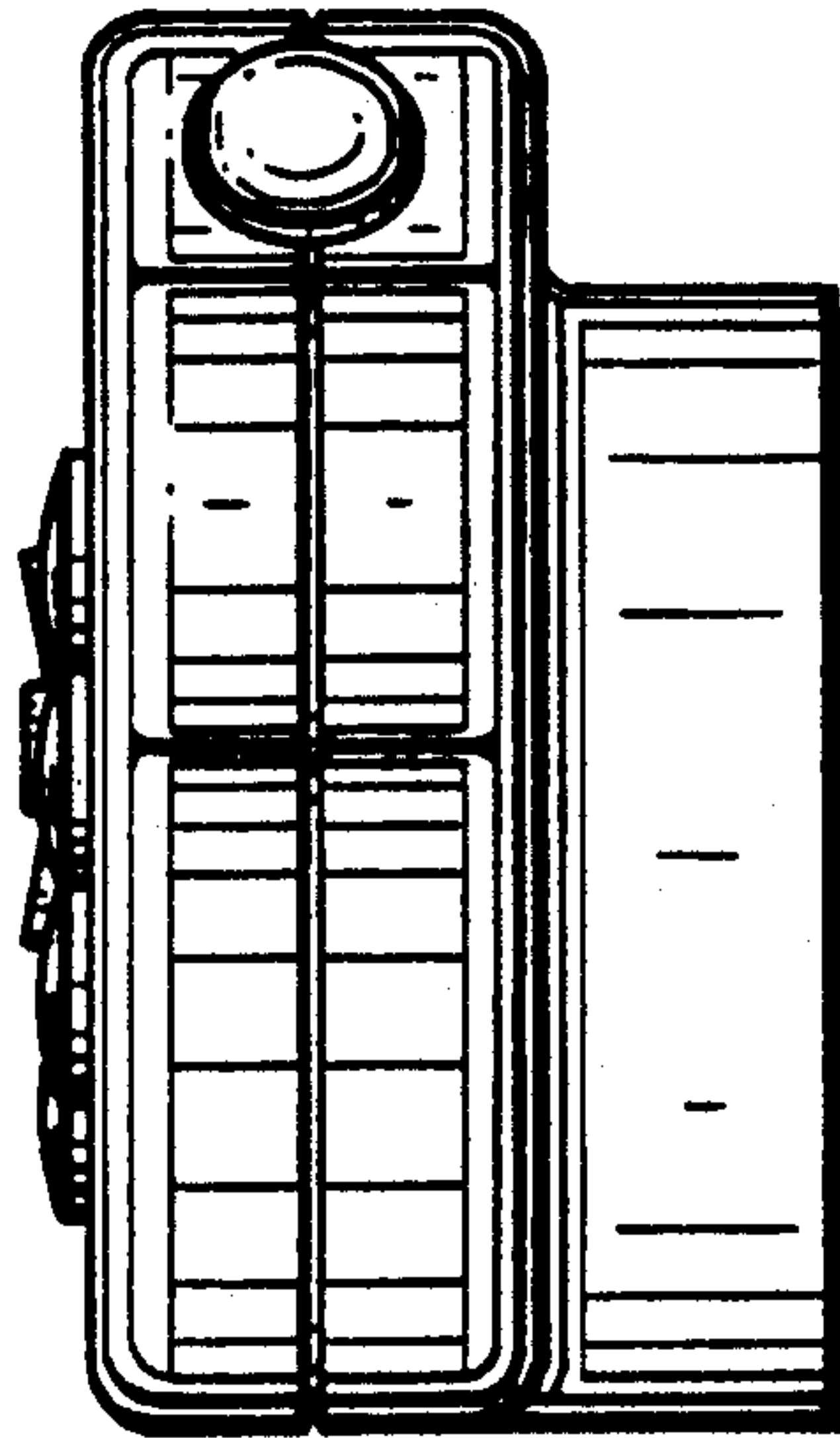

FIG. 6

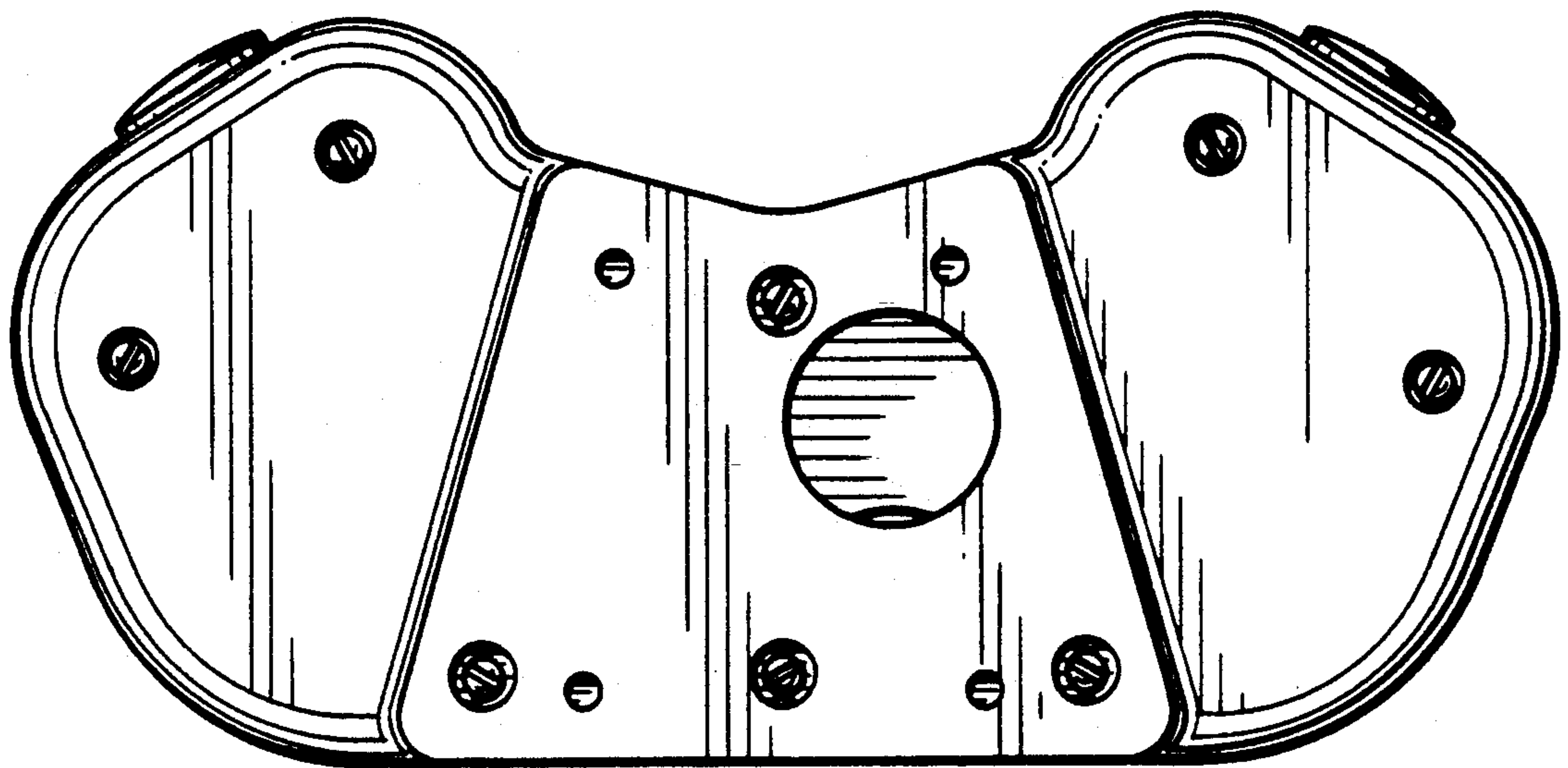
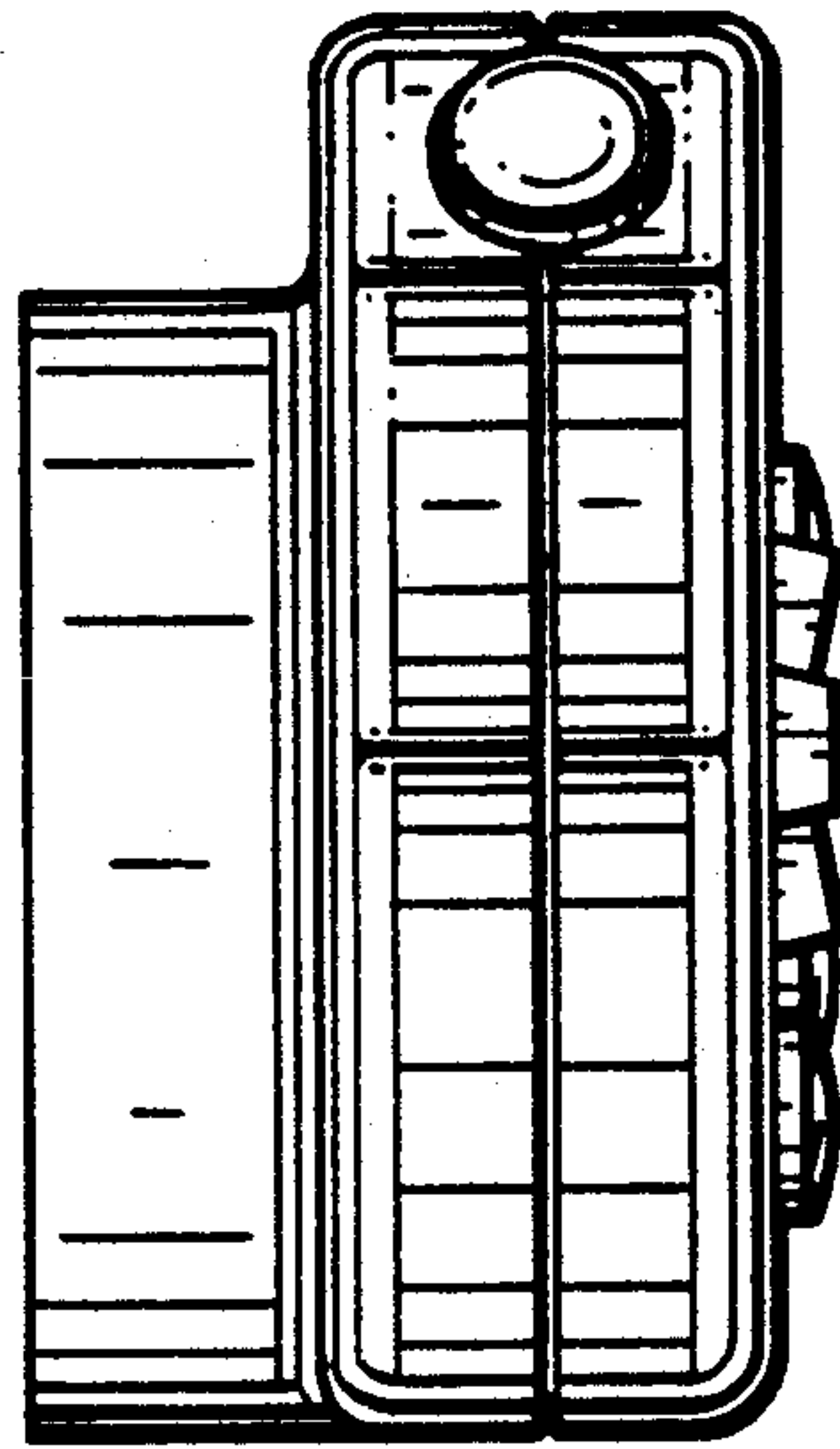

FIG. 5

FIG. 7

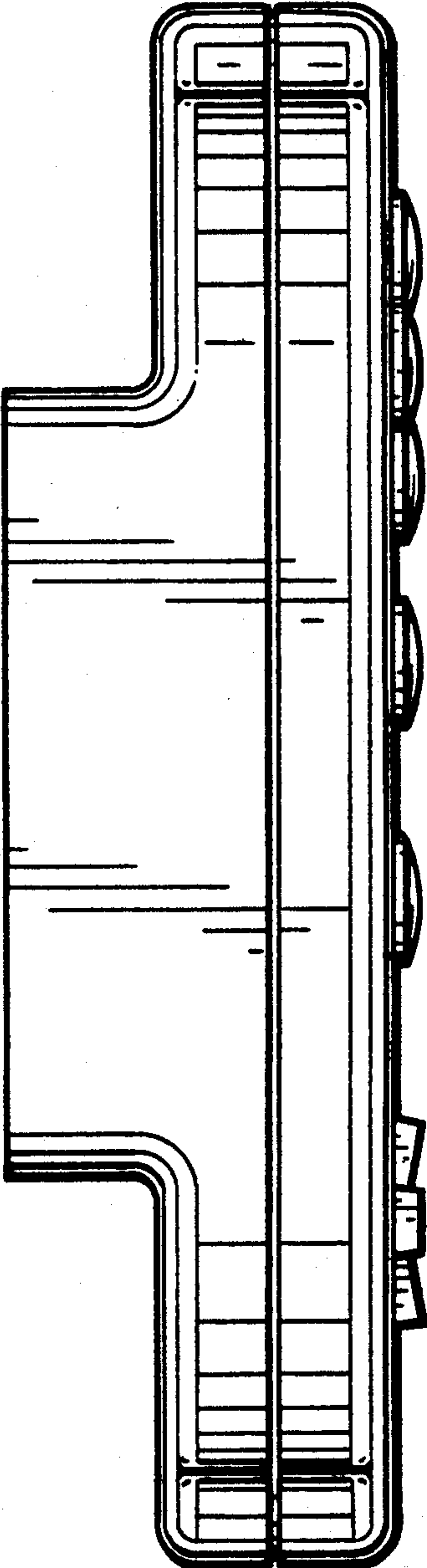

FIG. 9

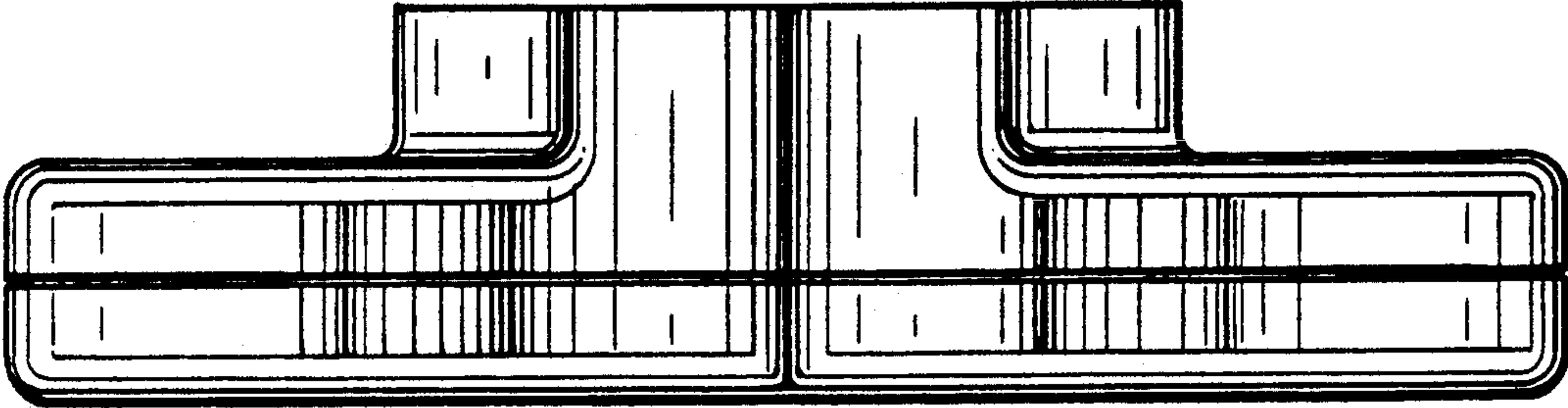

FIG. 10

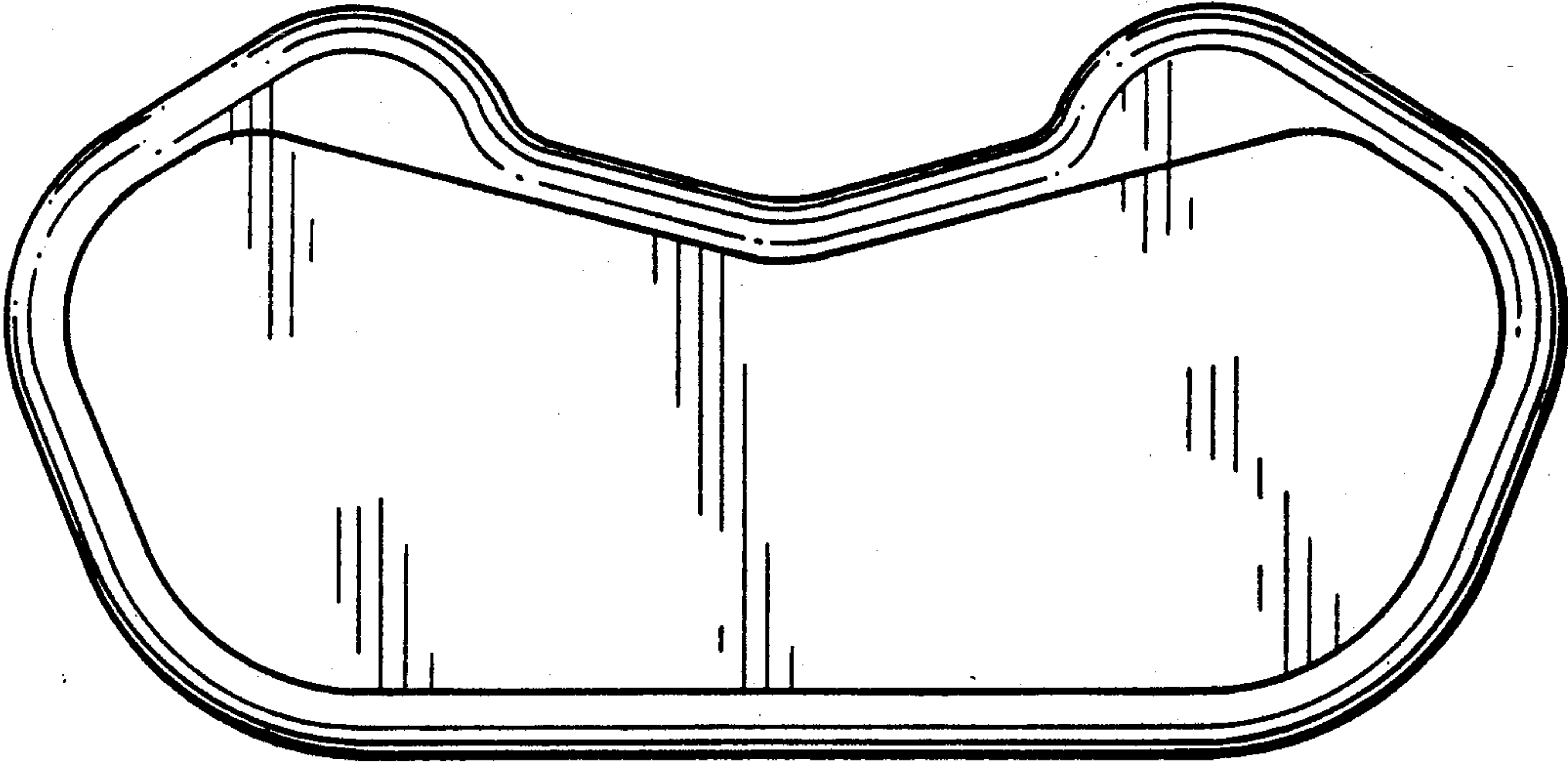

FIG. 11

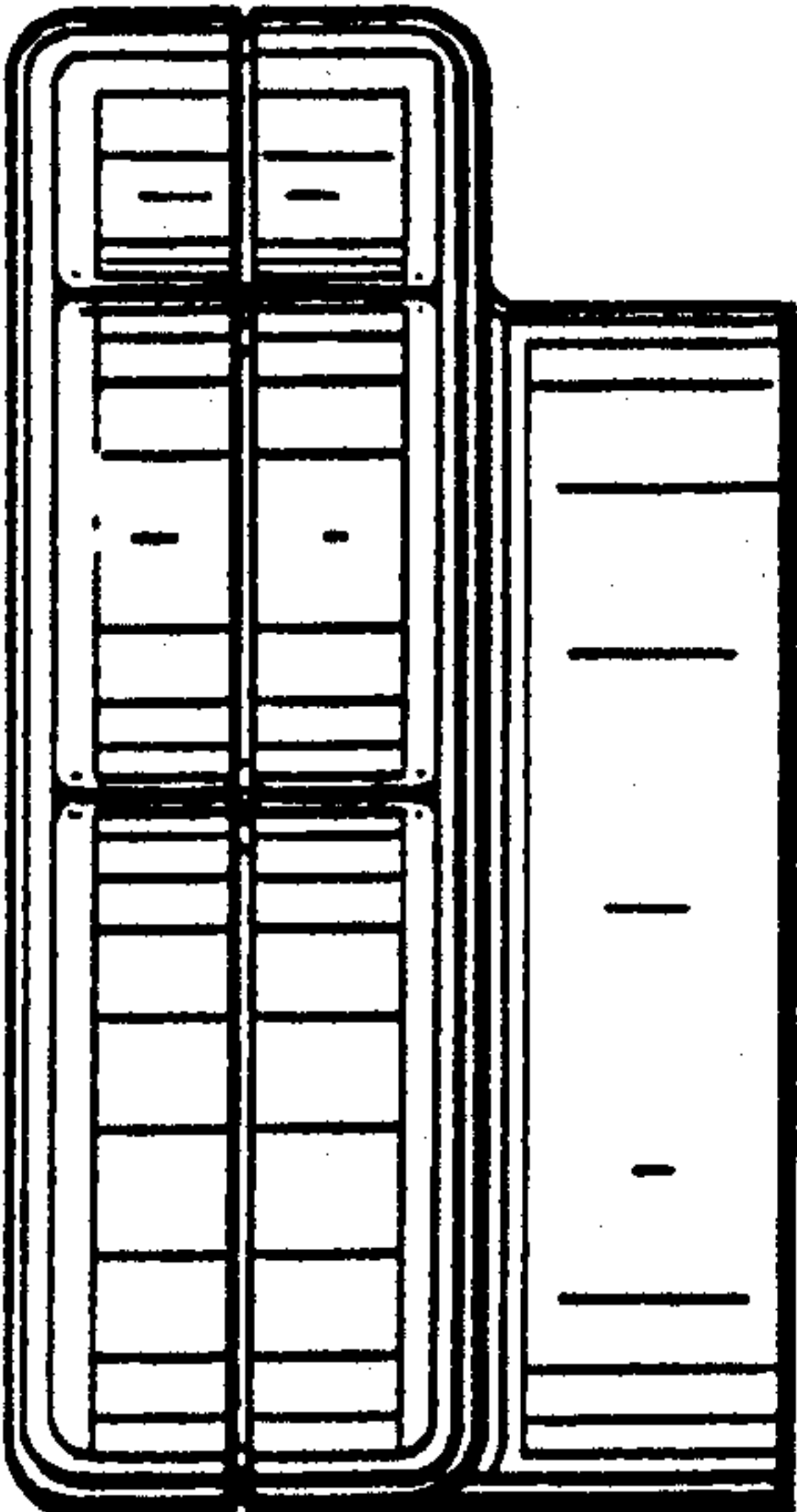

FIG. 13

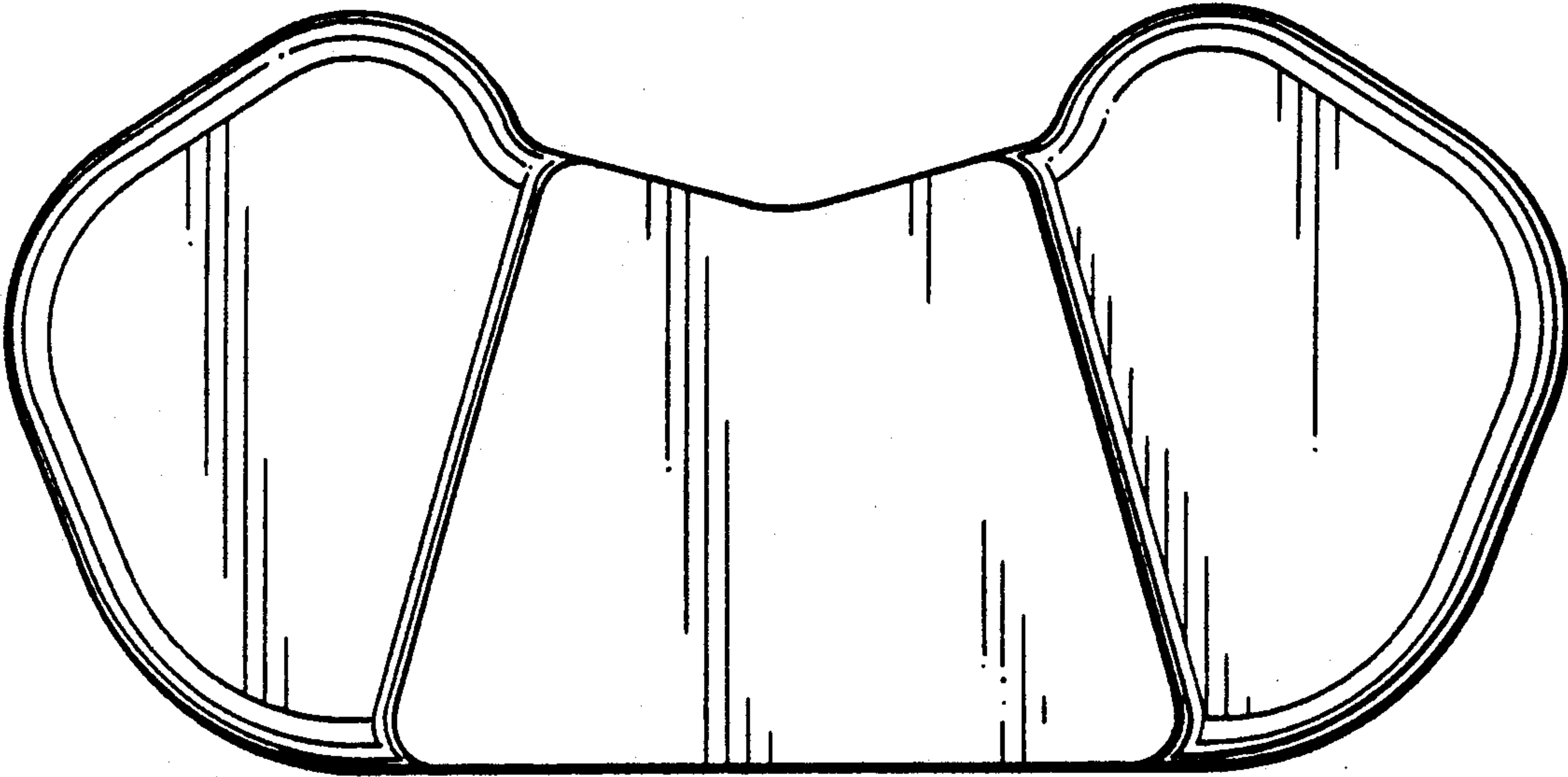
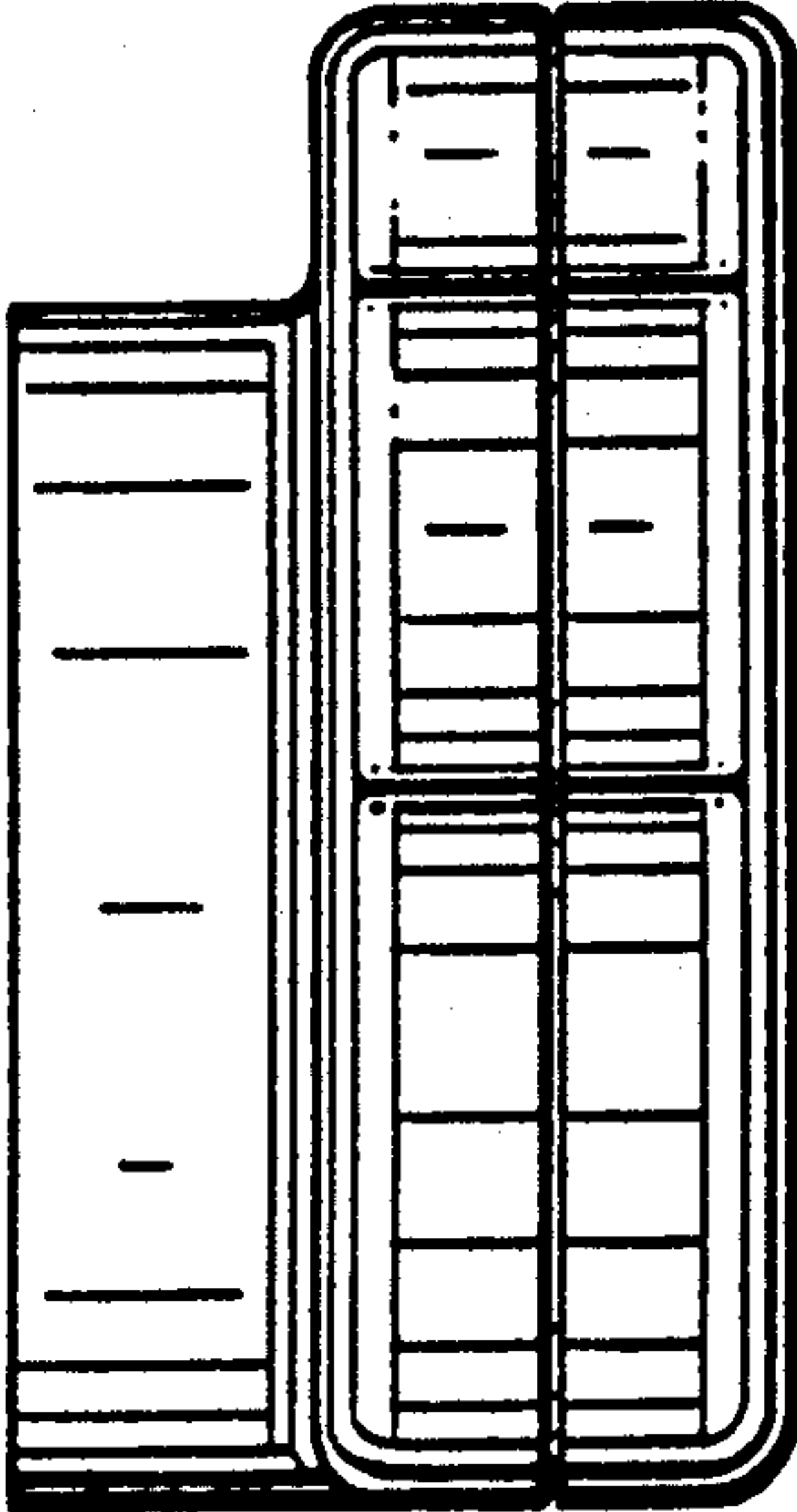

FIG. 12

FIG. 14

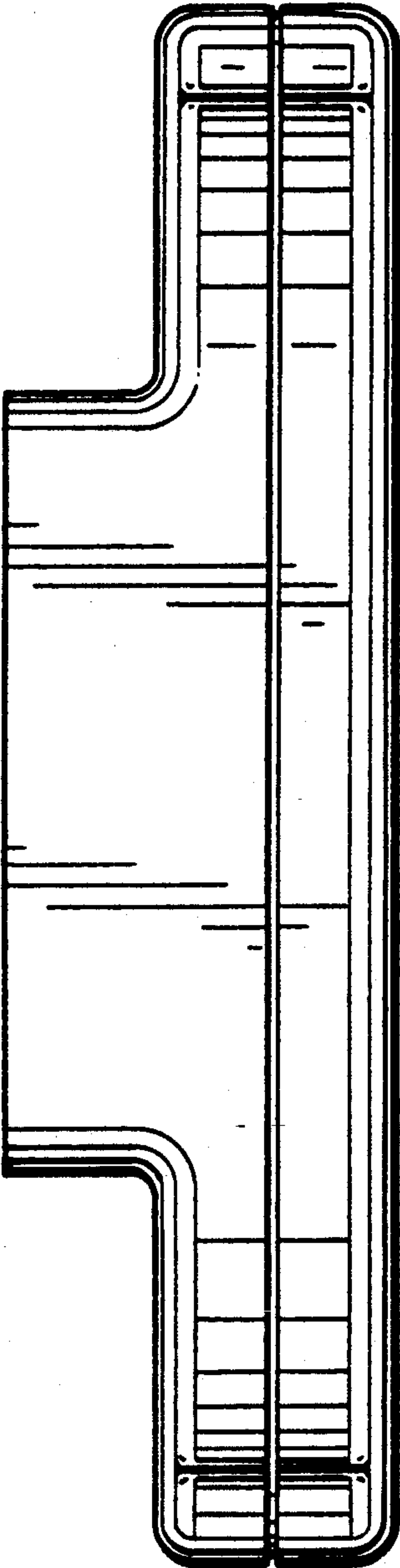

FIG. 15

