



US00D338192S

United States Patent [19]

[11] Patent Number: Des. 338,192

Savio

[45] Date of Patent: ** Aug. 10, 1993

[54] COUNTERTOP PROCESSOR

[75] Inventor: Dino M. Savio, Clearwater, Fla.

[73] Assignee: International Business Machines Corporation, Armonk, N.Y.

[**] Term: 14 Years

[21] Appl. No.: 1,145

[22] Filed: Oct. 23, 1992

D. 308,857	6/1990	Bianco	D14/100
D. 310,312	8/1990	Forsythe	D14/106
D. 319,251	8/1991	Ishida et al.	D18/4
D. 320,036	9/1991	Chen	D18/4
5,113,060	5/1992	Wike, Jr. et al.	235/383

OTHER PUBLICATIONS

Office Products, May 1979 p. 88 Electronic Cash Register.

Primary Examiner—Wallace R. Burke
Assistant Examiner—Freda S. Nunn
Attorney, Agent, or Firm—Romualdas Strimaitis

Related U.S. Application Data

[62] Division of Ser. No. 524,761, May 15, 1990.

[52] U.S. Cl. D14/105; D18/4

[58] Field of Search D14/100, 101, 105, 106, D14/107, 113, 115; D18/1, 4, 7; 235/145 A, 145 R, 2, 6, 7 R, 383; 364/405, 706-708; 340/700, 706; 341/22, 23; 361/390; 194/205

[57] CLAIM

The ornamental design for countertop processor, as shown and described.

[56] References Cited

U.S. PATENT DOCUMENTS

D. 260,990	9/1981	Williams	D14/105
D. 269,623	7/1983	Kato et al.	D14/105 X
D. 303,537	9/1989	Kato et al.	D18/4
D. 304,444	11/1989	Ikeya	D14/105

DESCRIPTION

FIG. 1 is a right front perspective view of a countertop processor showing my new design; FIG. 2 is a left rear perspective view thereof; FIG. 3 is a right side view thereof; FIG. 4 is a front view thereof; FIG. 5 is a left side view thereof; and, FIG. 6 is a rear view thereof. FIGS. 3-6 are drawn on a slightly enlarged scale.

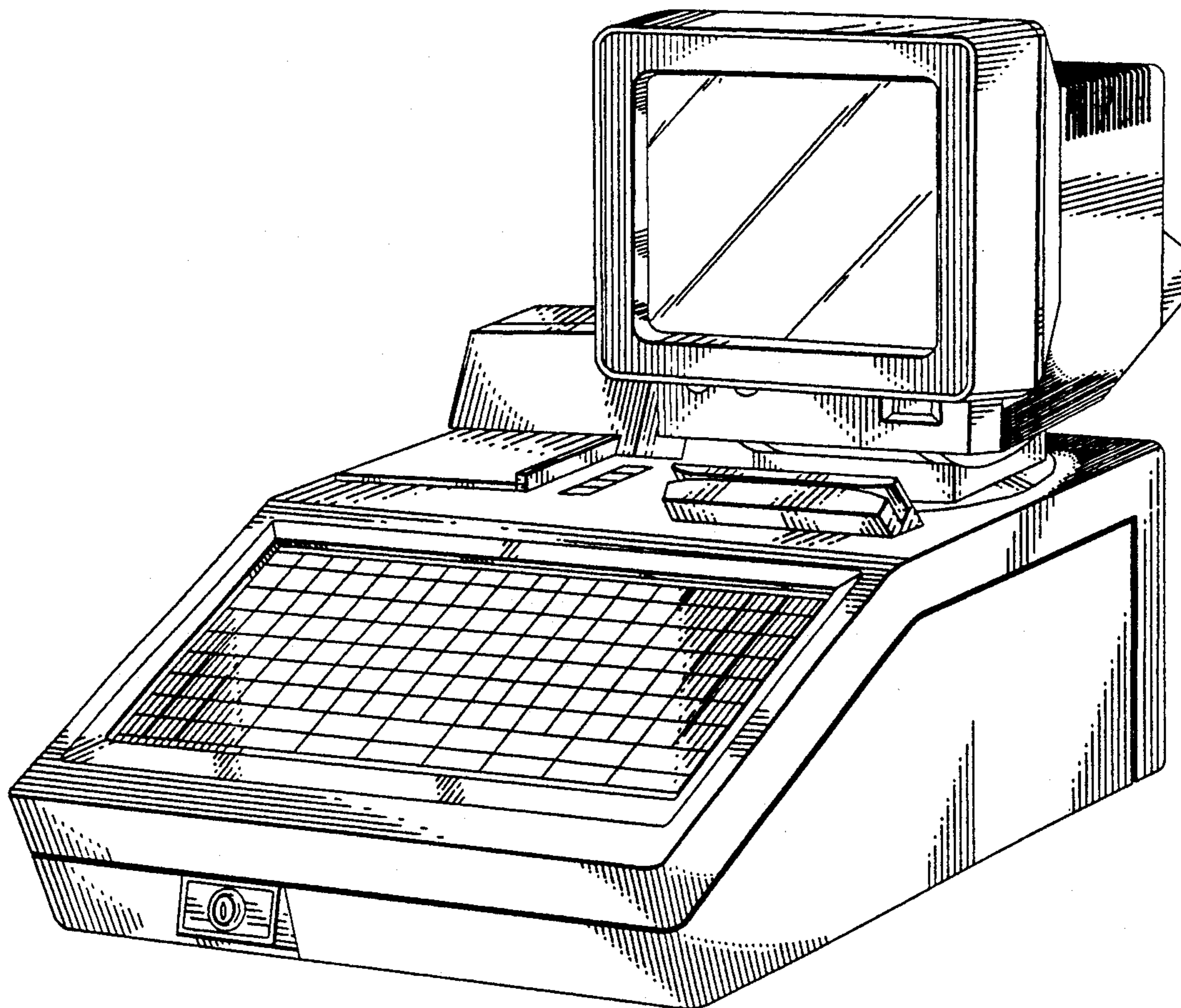

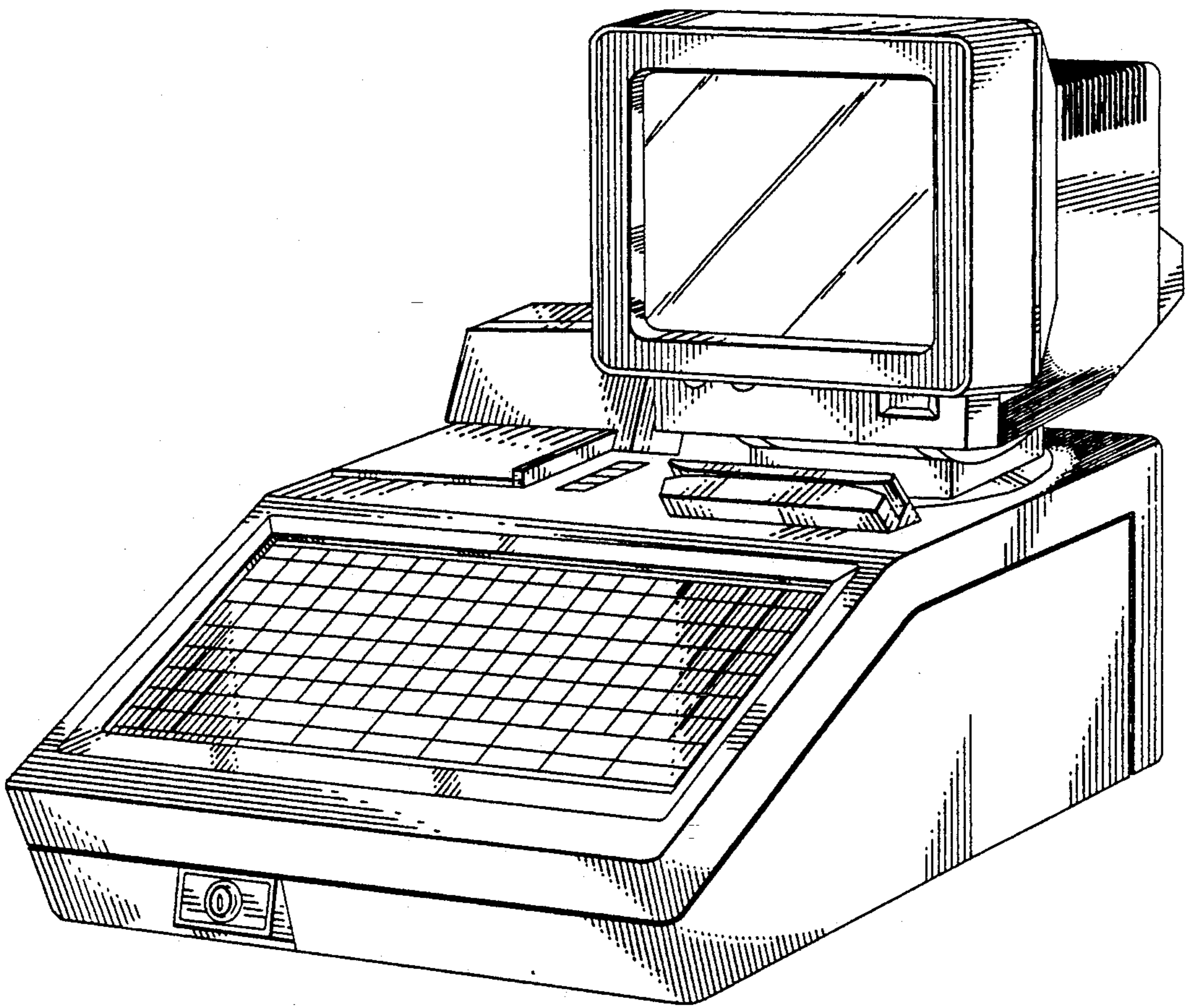

FIG. 1

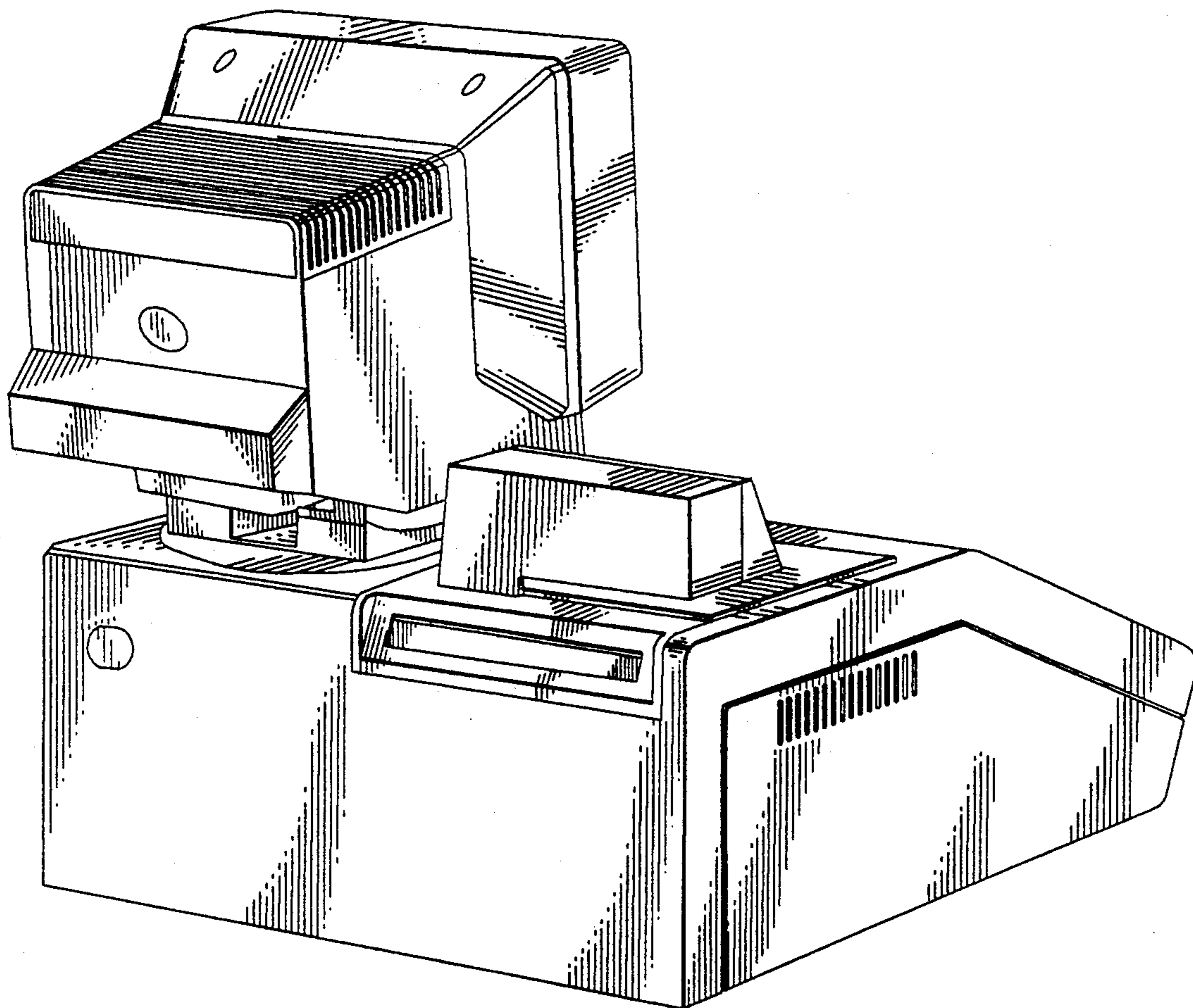

FIG. 2

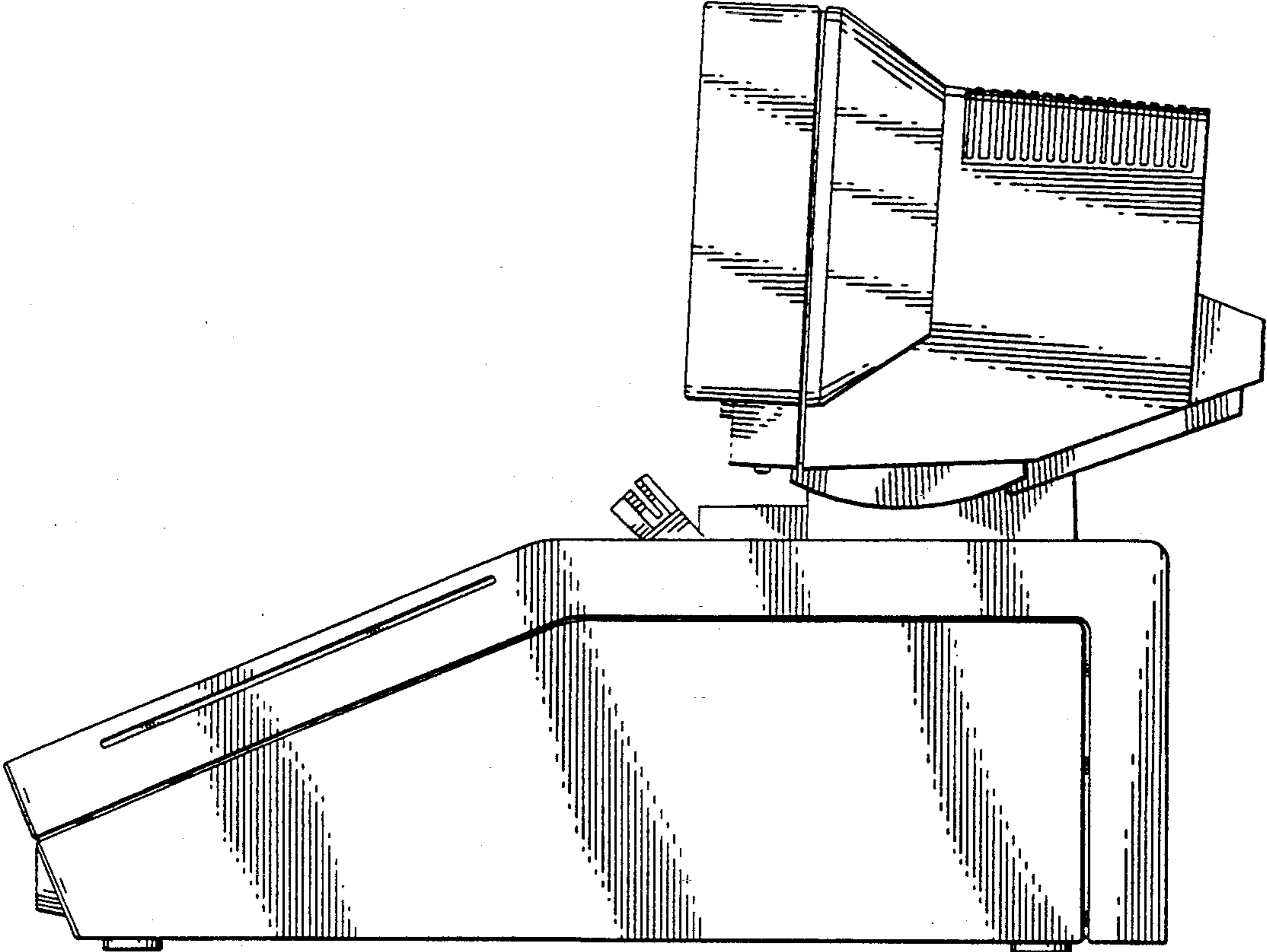

FIG. 3

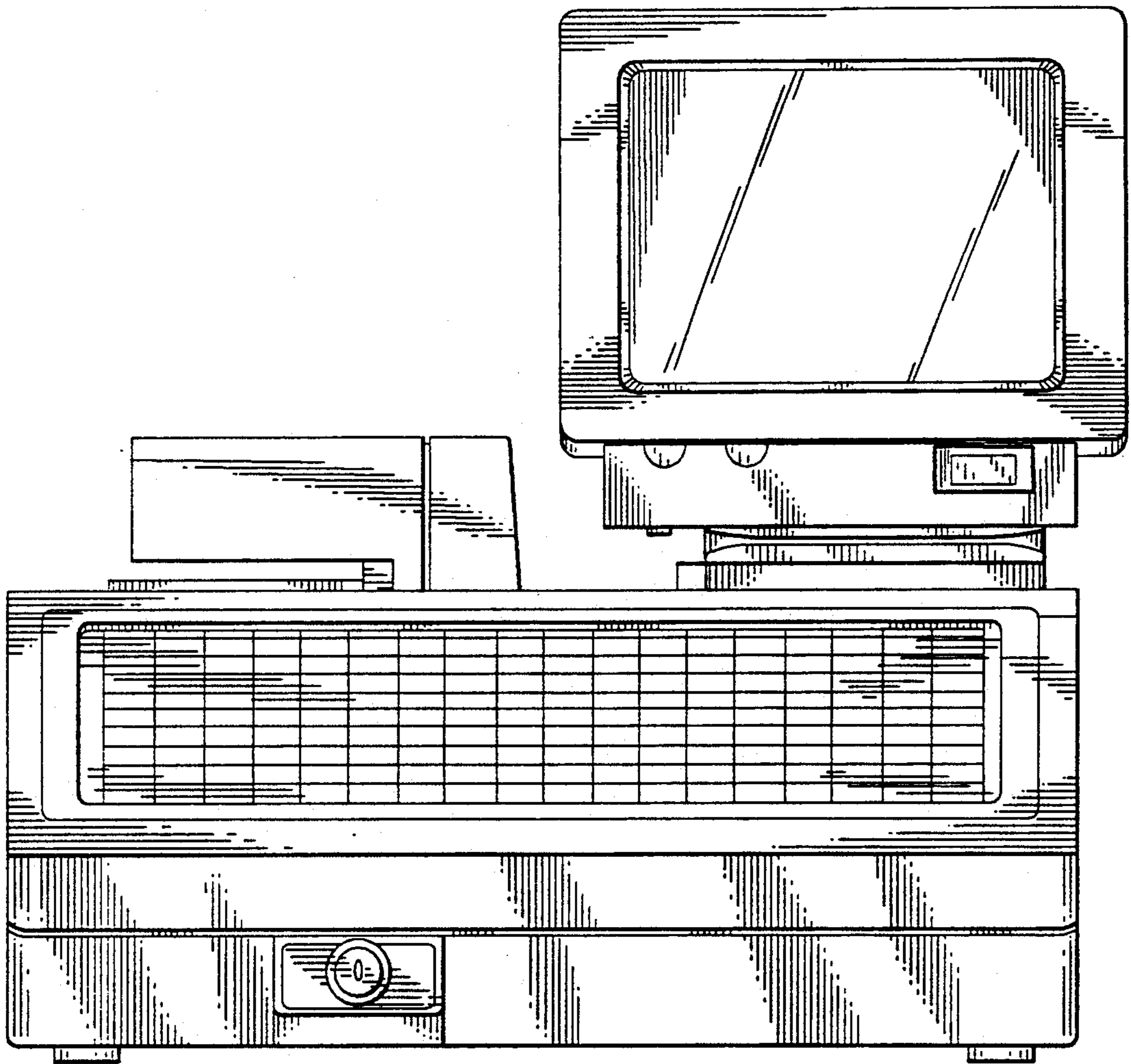

FIG. 4

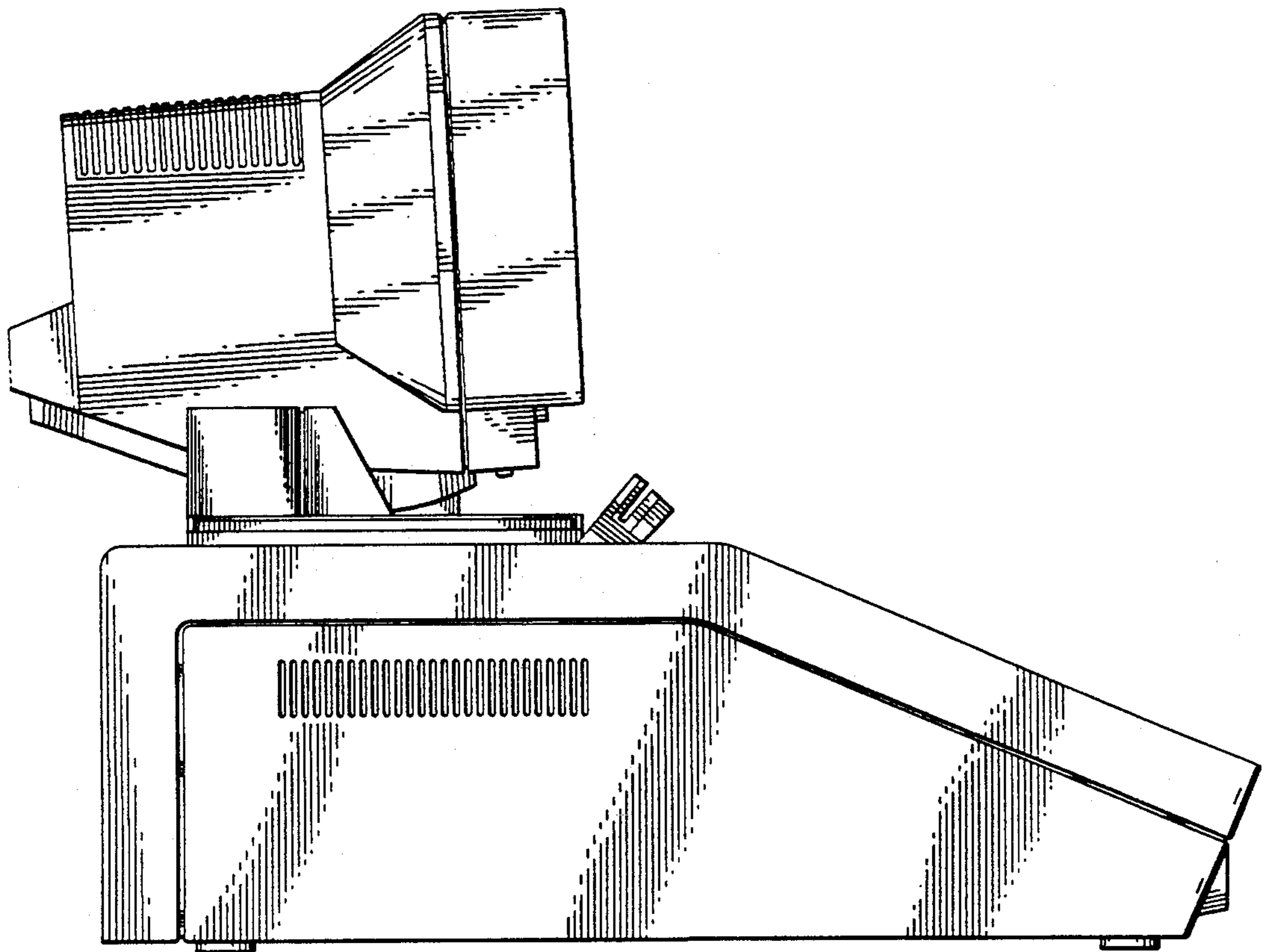

FIG. 5

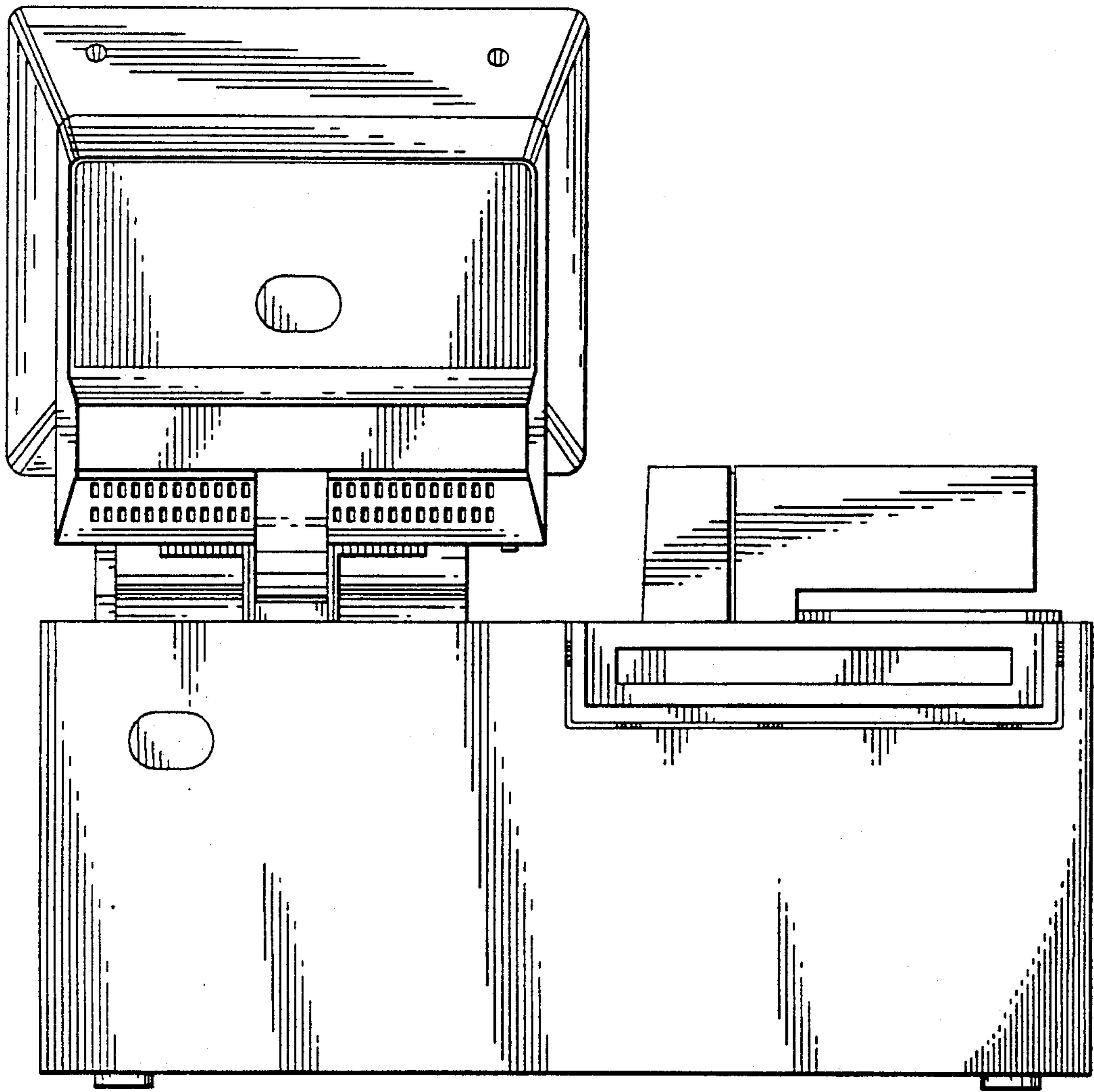

FIG. 6