



US00D338133S

United States Patent [19]

[11] Patent Number: **Des. 338,133**

Mano et al.

[45] Date of Patent: **** Aug. 10, 1993**

[54] COOK POT WITH COVER

[75] Inventors: **Kaori Mano; Nobuyuki Enomoto,**
both of Kyoto, Japan

[73] Assignee: **Japan Oxygen Co., Ltd., Tokyo,**
Japan

[**] Term: **14 Years**

[21] Appl. No.: **472,672**

[22] Filed: **Jan. 30, 1990**

[30] Foreign Application Priority Data

Aug. 2, 1989 [JP] Japan 1-28566

[52] U.S. Cl. **D7/360; D7/354**

[58] Field of Search **D7/323, 354, 356, 358,**
D7/360; 220/912; 99/413, 417, 426, 467, 324

[56] References Cited

U.S. PATENT DOCUMENTS

D. 160,070 9/1950 Carr **D7/360**
4,735,135 4/1988 Walker D7/409 X

OTHER PUBLICATIONS

Hong Kong Household; Jul. 1983; p. 8; Cook Pots
upper left corner.

Primary Examiner—Alan P. Douglas
Assistant Examiner—Caron D. Veynar
Attorney, Agent, or Firm—Lowe, Price, LeBlanc &
Becker

[57] CLAIM

The ornamental design for a cook pot with cover, as
shown and described.

DESCRIPTION

FIG. 1 is a right, front and top perspective view of a
cook pot with cover showing our new design;
FIG. 2 is a bottom and rear perspective view thereof;
FIG. 3 is a front elevational view thereof;
FIG. 4 is a rear elevational view thereof;
FIG. 5 is a right side elevational view thereof, the left
side elevational view is a mirror image thereof;
FIG. 6 is a top plan view thereof;
FIG. 7 is a bottom plan view thereof; and,
FIG. 8 is a right, front and top perspective view thereof,
the inner container removed for ease of illustration.

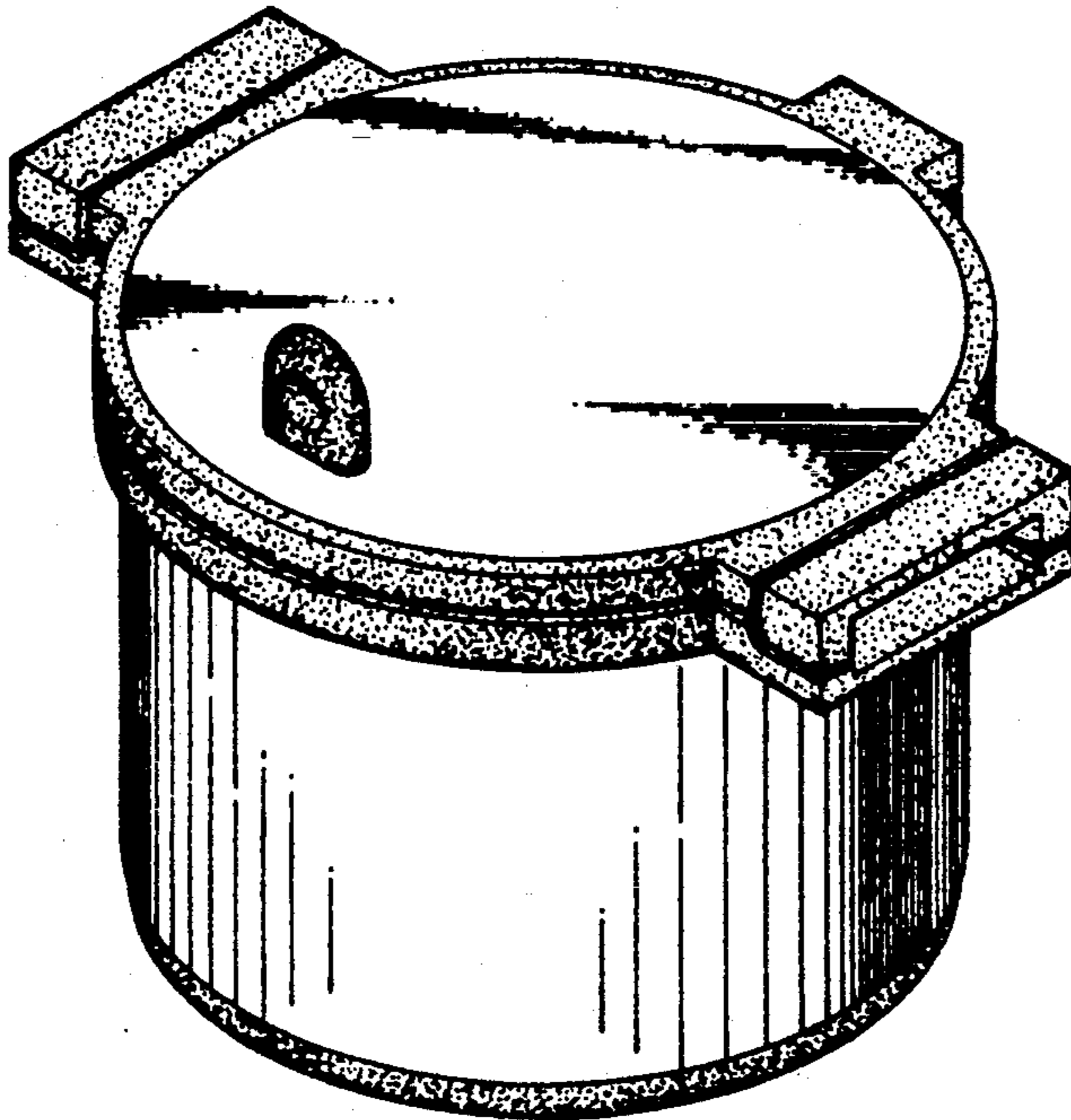

FIG. 1

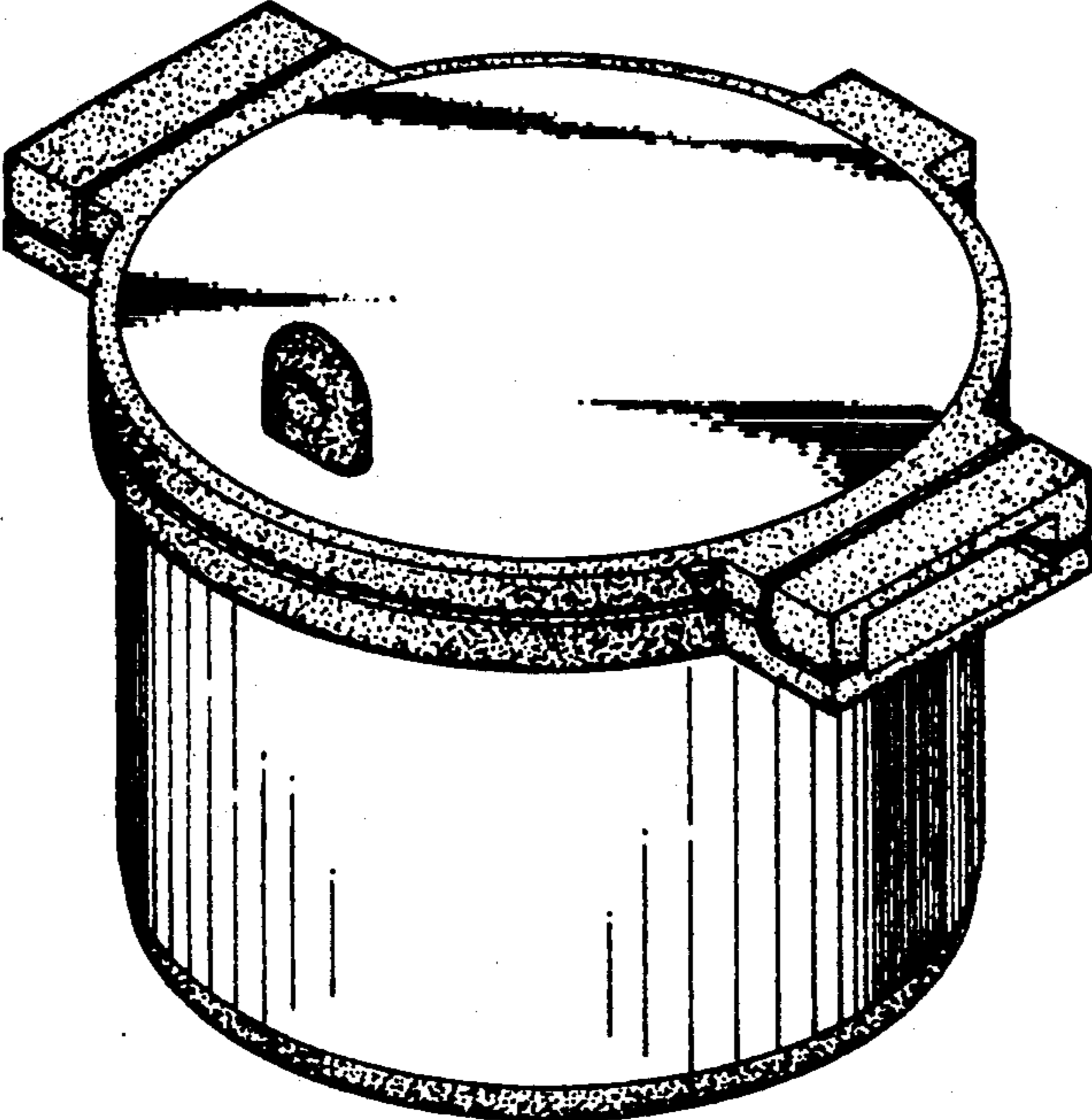

FIG. 2

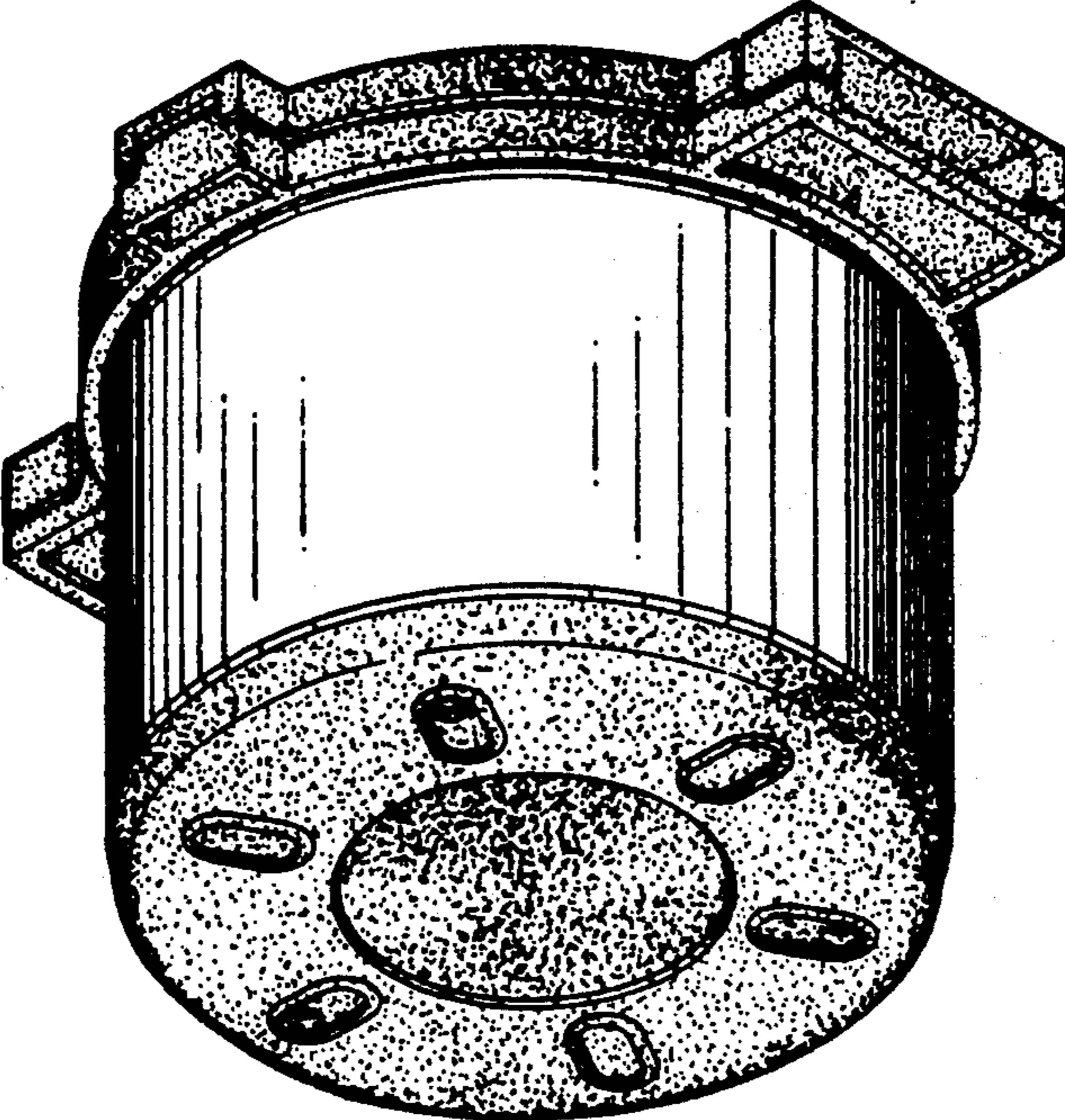

FIG.3

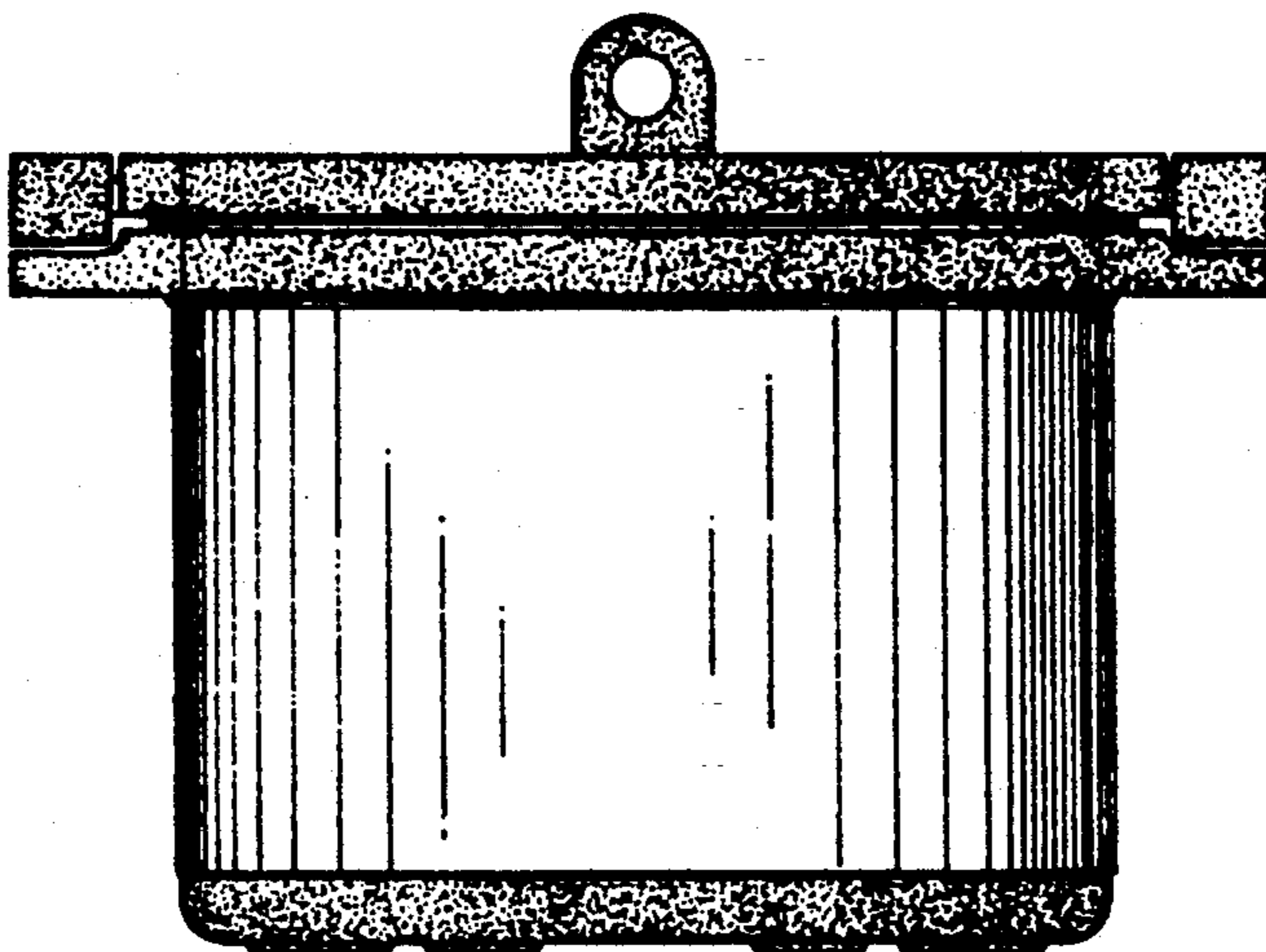

FIG.4

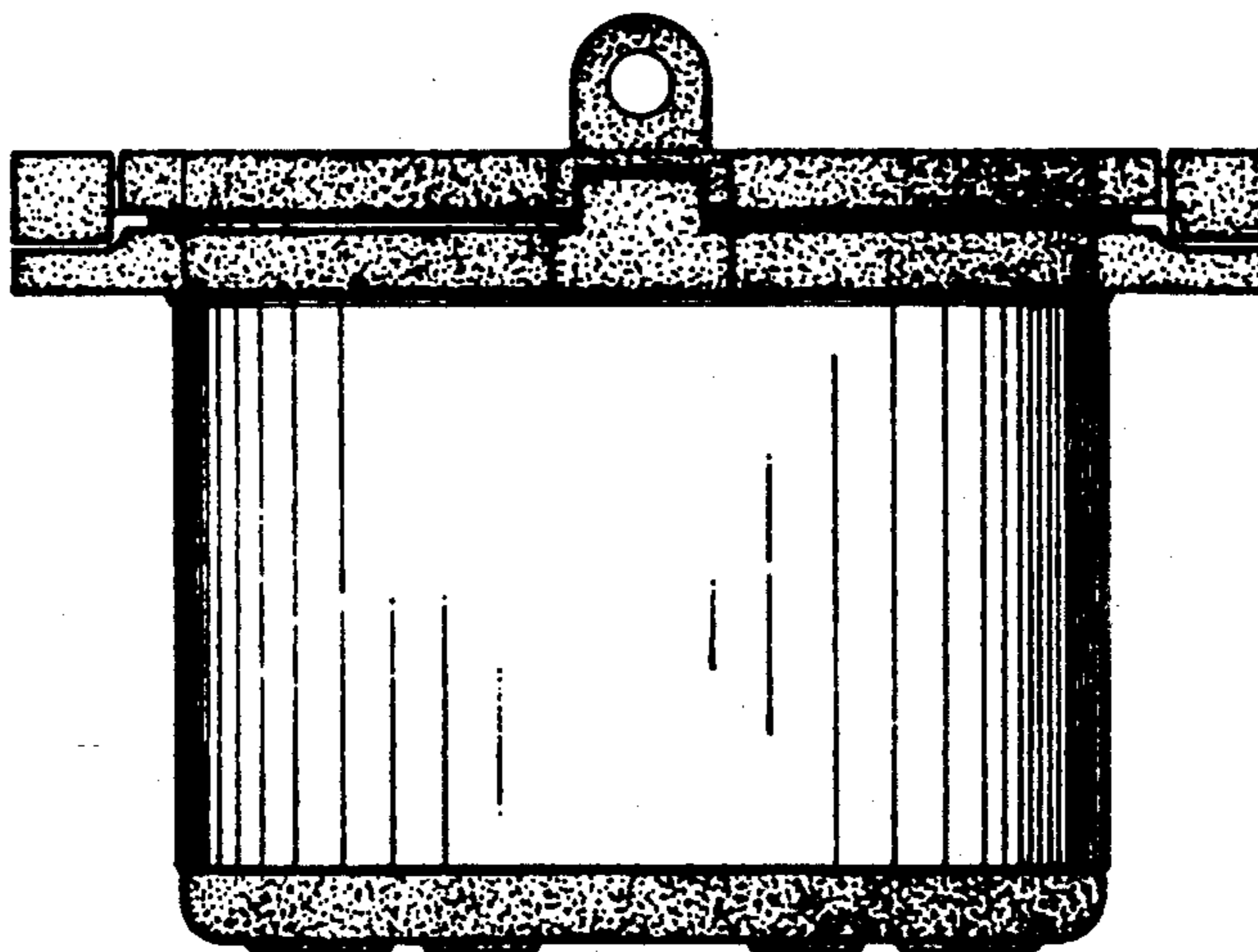

FIG.5

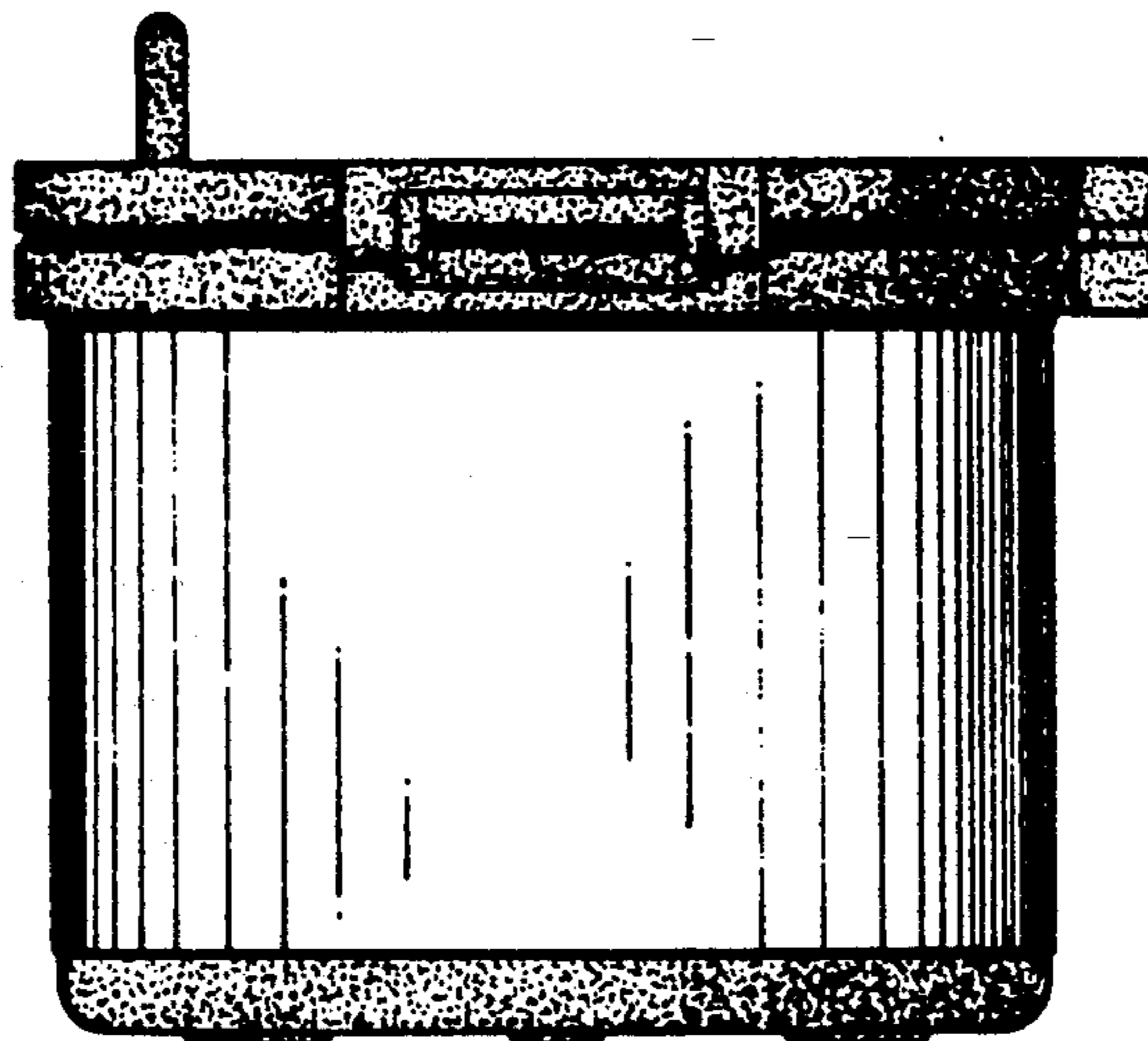

FIG. 6

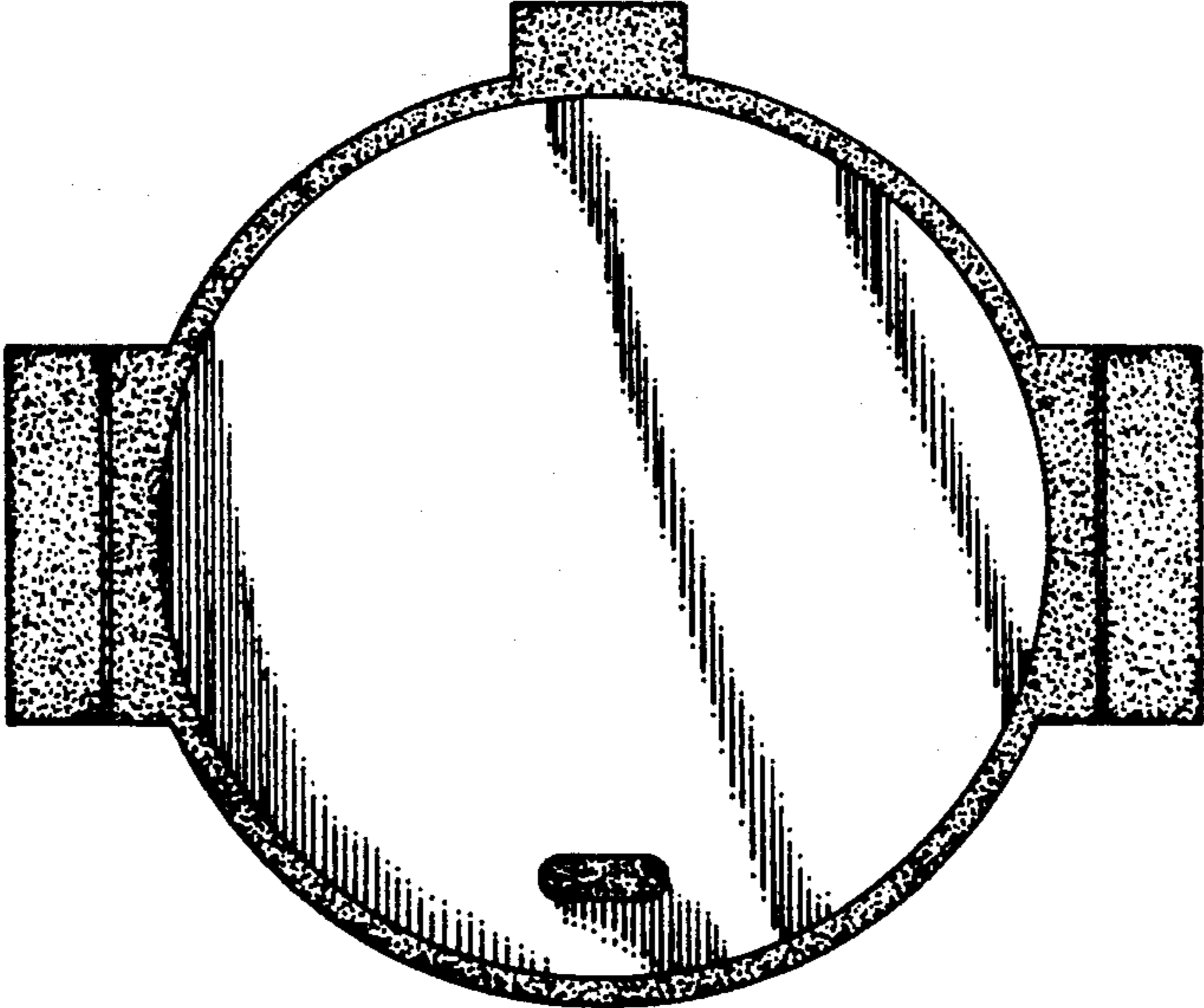

FIG. 7

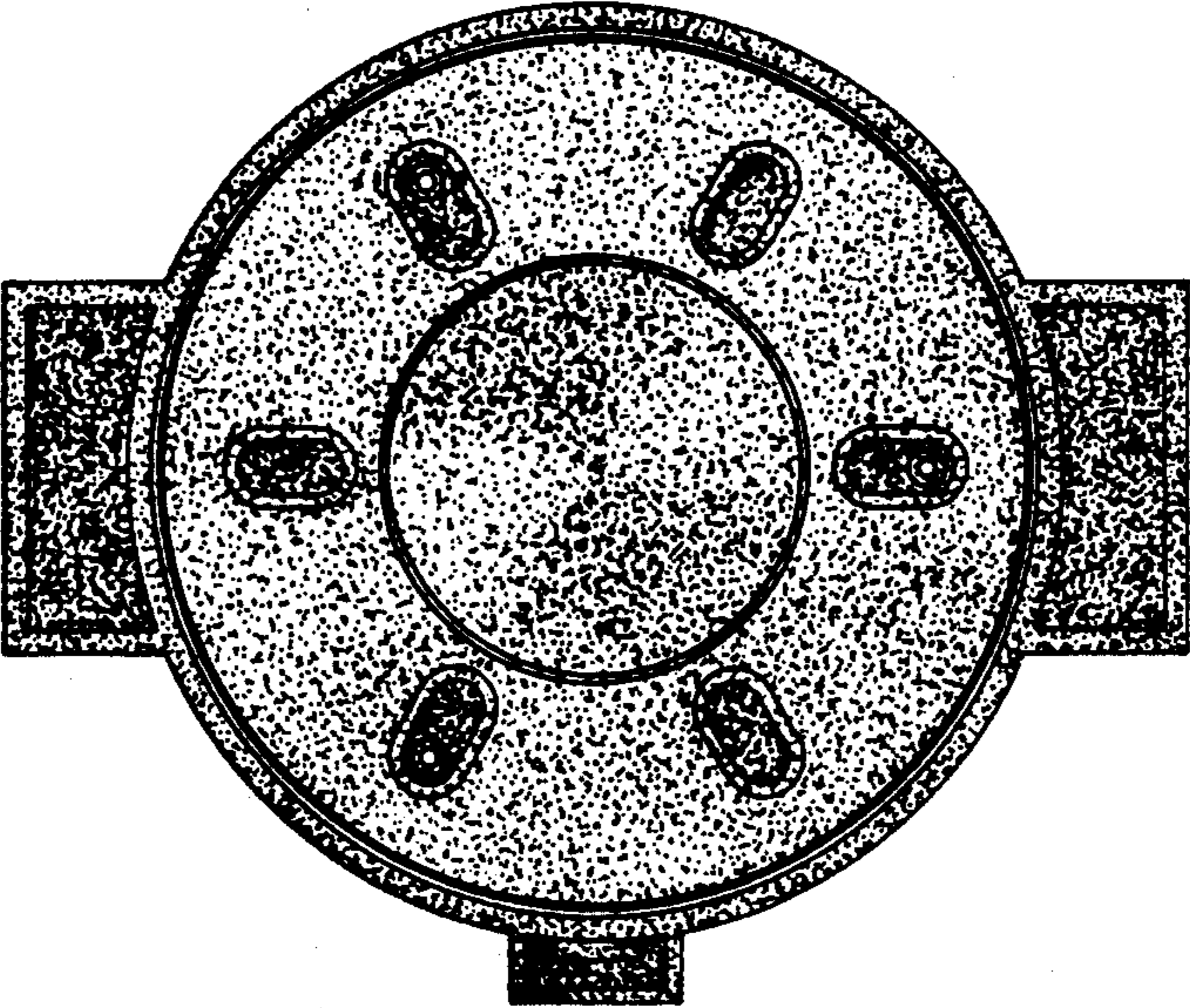

FIG. 8

