



US00D338090S

United States Patent [19]

Kamiyama

[11] Patent Number: **Des. 338,090**

[45] Date of Patent: **** Aug. 3, 1993**

[54] WINDOW WASHING DEVICE

[76] Inventor: **Yoshiko Kamiyama**, P.O. Box 199,
Irvington, N.Y. 10533

[**] Term: **14 Years**

[21] Appl. No.: **732,672**

[22] Filed: **Jul. 19, 1991**

[52] U.S. Cl. **D32/45**

[58] Field of Search **D4/114, 119;**
D32/40-42, 45, 50-51; 15/104.92, 118, 119.2,
143.1, 209.1, 210.1, 220.1, 244.1, 244.4, 245;
401/16, 25, 27, 130, 136-140, 261, 266, 268

[56] **References Cited**

U.S. PATENT DOCUMENTS

D. 227,731	7/1973	Ball et al.	D32/42
2,436,454	2/1948	Sensenbach et al.	401/139
2,770,826	11/1956	Curfman	15/105

4,124,915	11/1978	Schlicher	15/105
4,317,250	3/1982	Shutts	15/245 X
4,716,616	1/1988	Poon	15/245

Primary Examiner—Wallace R. Burke
Assistant Examiner—Lavone D. Tabor
Attorney, Agent, or Firm—Terry M. Gernstein

[57] **CLAIM**

The ornamental design for a window washing device, as shown and described.

DESCRIPTION

FIG. 1 is a perspective view of the window washing device embodying the design of the present invention; FIG. 2 is a front end elevational view thereof; FIG. 3 is a rear end elevational view thereof; FIG. 4 is a side elevational view thereof, the side opposite being a mirror image of the side shown in FIG. 4; FIG. 5 is a top plan view thereof; and, FIG. 6 is a bottom view thereof.

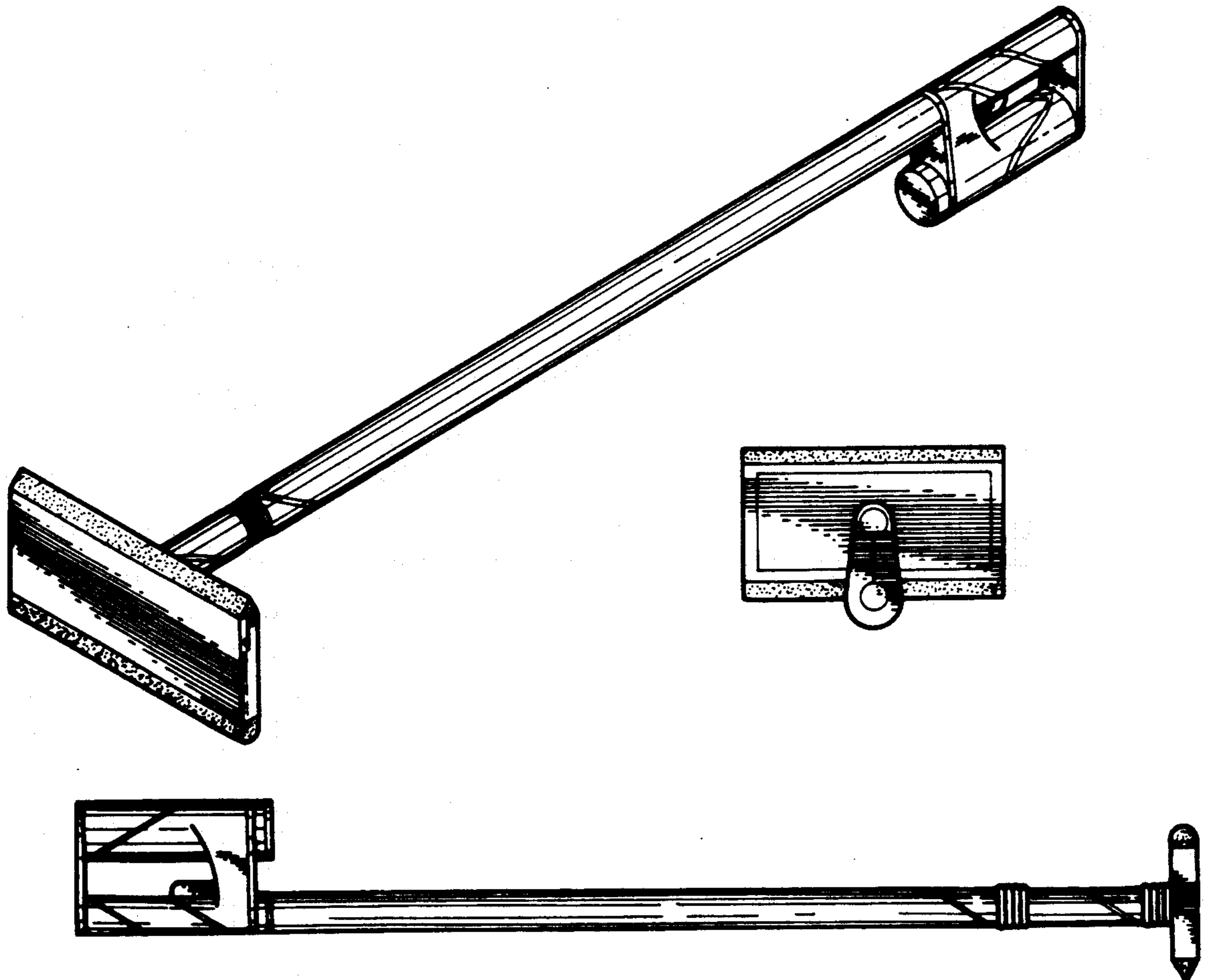

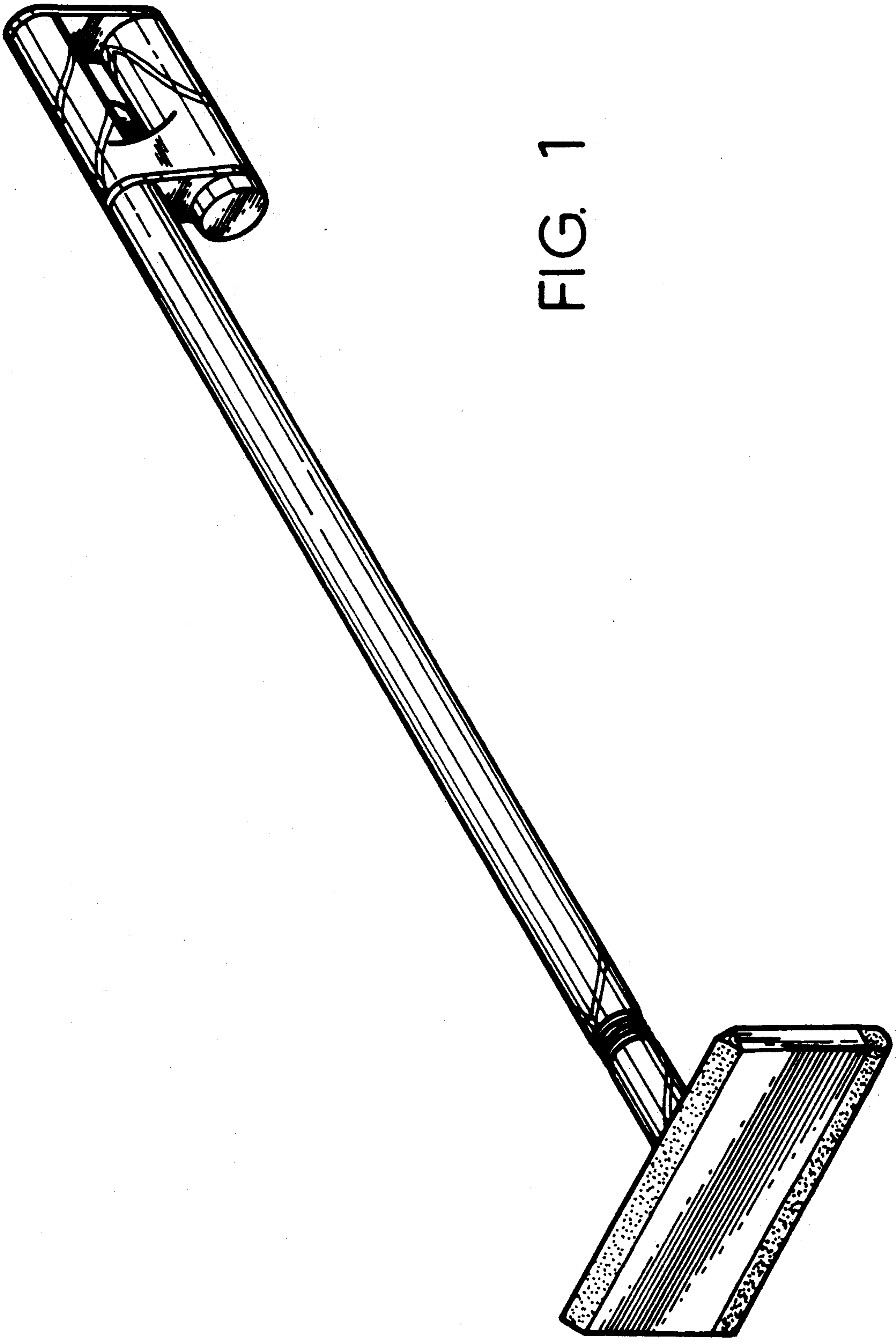

FIG. 1

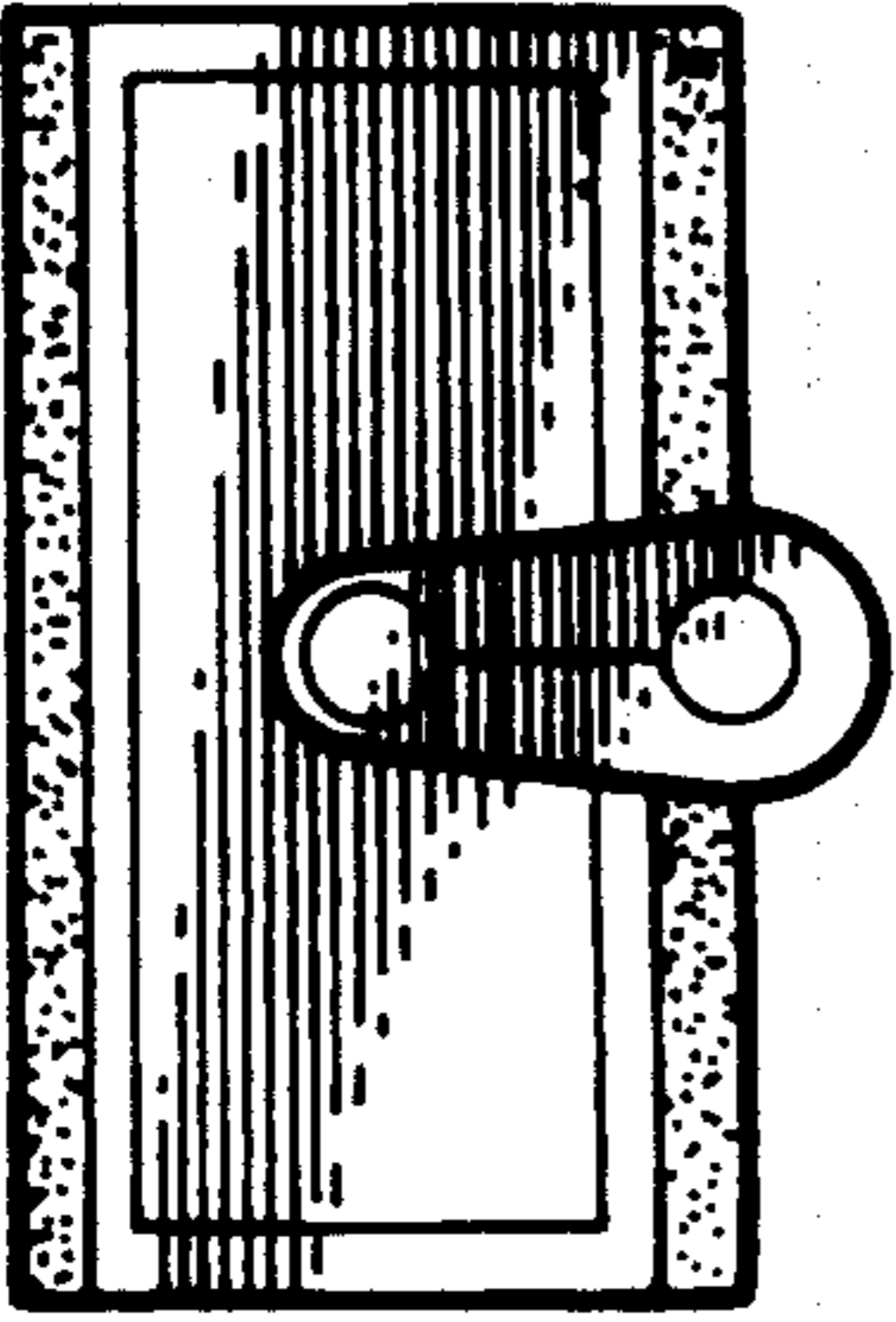

FIG. 2

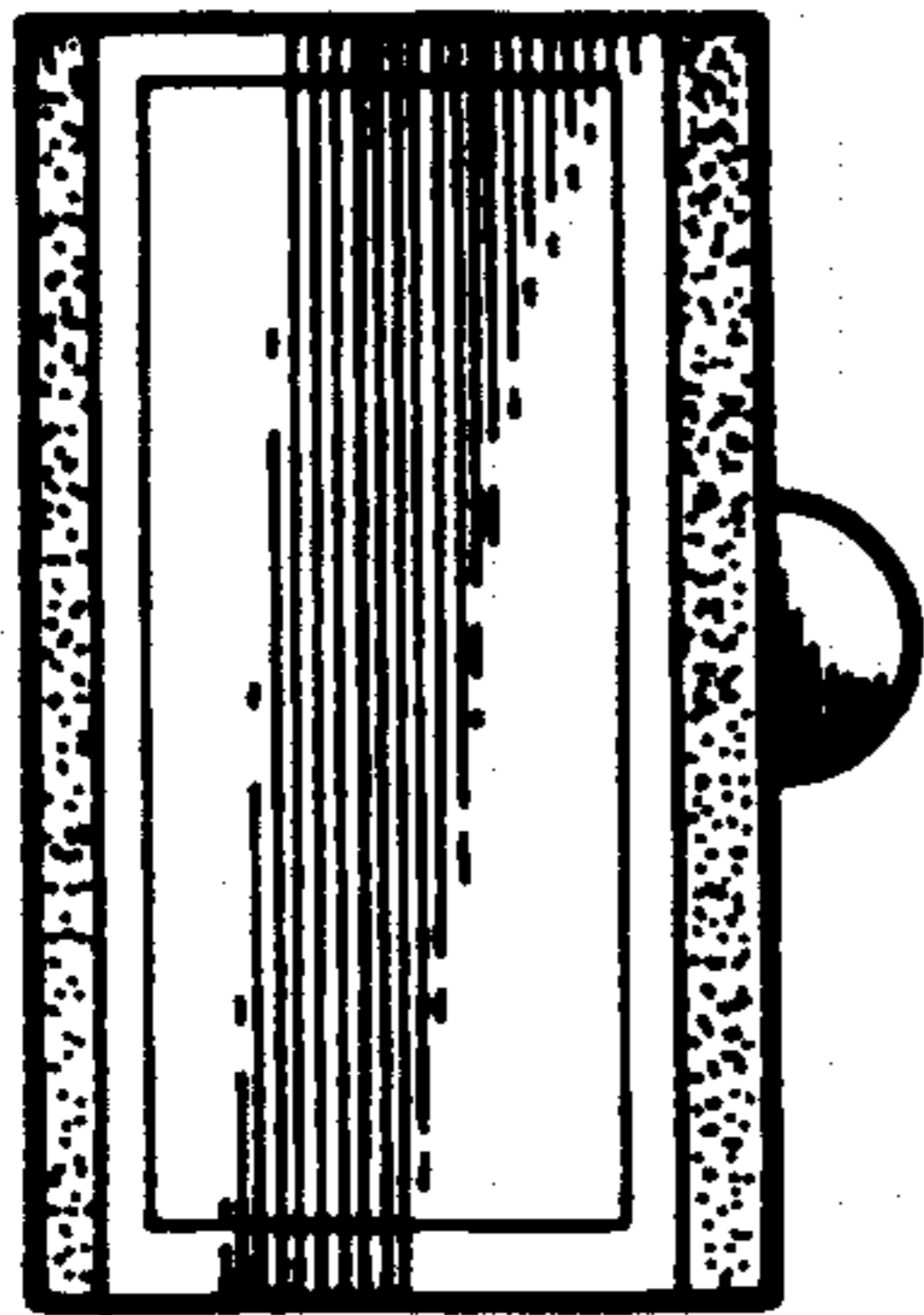

FIG. 3

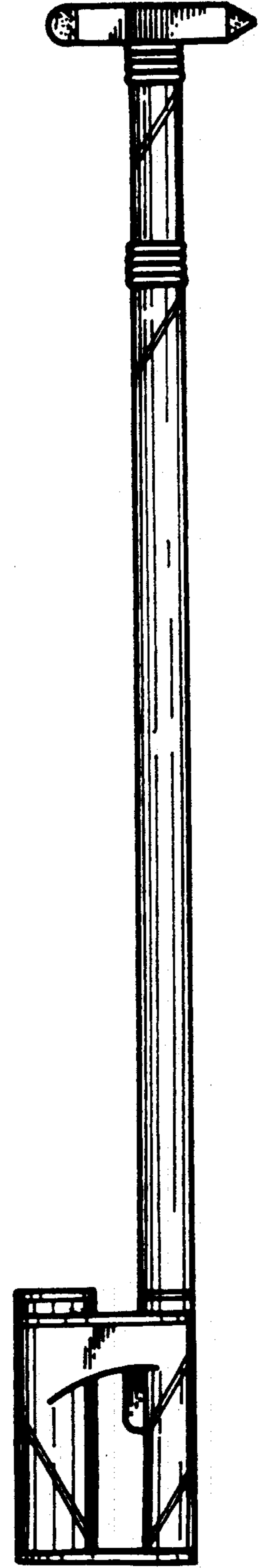

FIG. 4

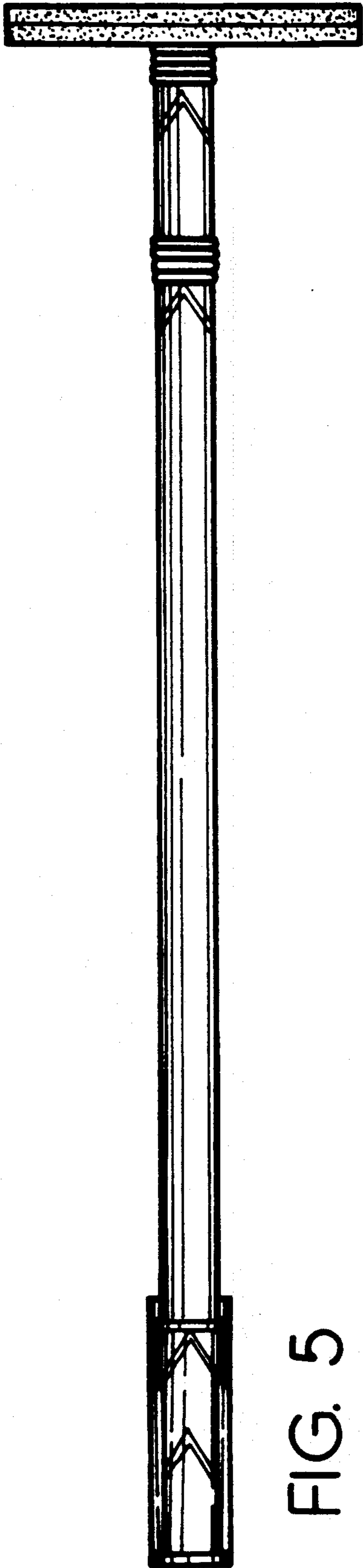

FIG. 5

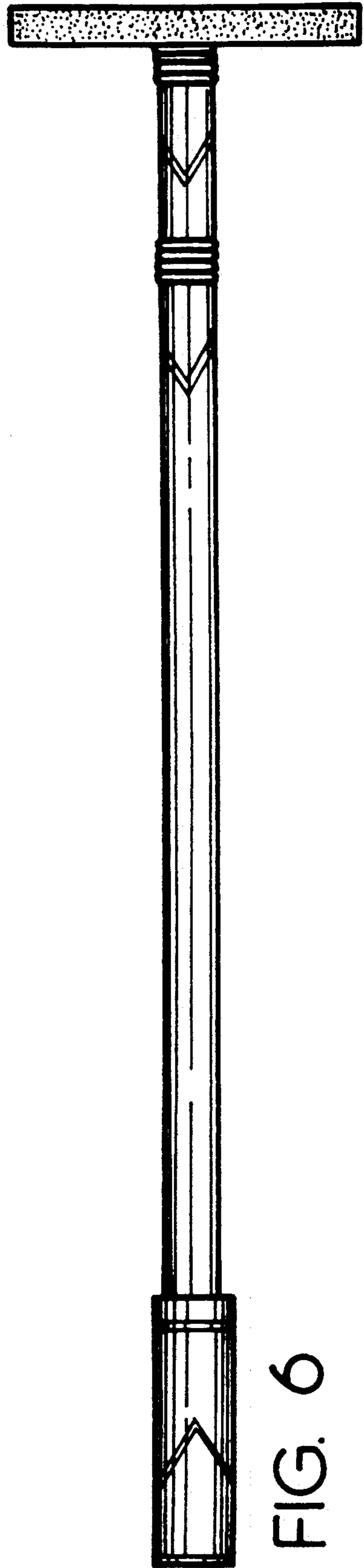

FIG. 6