



US00D337846S

United States Patent [19]
Fiorato

[11] **Patent Number: Des. 337,846**
[45] **Date of Patent: ** Jul. 27, 1993**

[54] **WALL LAMP**

[75] **Inventor: Roberto Fiorato, Verona, Italy**

[73] **Assignee: Prisma S.p.A., Colognola ai Colli, Italy**

[**] **Term: 14 Years**

[21] **Appl. No.: 668,411**

[22] **Filed: Mar. 11, 1991**

[30] **Foreign Application Priority Data**

Sep. 12, 1990 [IT] Italy 21736/90

[52] **U.S. Cl. D26/85**

[58] **Field of Search D26/72, 80-92;
362/147, 432**

[56] **References Cited**

U.S. PATENT DOCUMENTS

D. 214,938 8/1969 Pettingill D26/85
D. 239,858 5/1976 Scarpa D26/87

OTHER PUBLICATIONS

Bega Wall Mounted Outdoor/Indoor Luminaires Catalog, 1987, p. 10, Wall Mounted Luminaire 3072.

Perfeclite Products Incandescent Lighting Catalog, 1952, p. 44, Hospital Bed Light HBL-4.

Primary Examiner—Susan J. Lucas

Attorney, Agent, or Firm—Darby & Darby

[57] **CLAIM**

The ornamental design for a wall lamp, as shown and described.

DESCRIPTION

FIG. 1 is a front perspective view of a wall lamp showing my new design;

FIG. 2 is a front elevational view thereof on a reduced scale;

FIG. 3 is a right side elevational view thereof on a reduced scale, the opposite side being a mirror image;

FIG. 4 is a top plan view thereof on a reduced scale;

FIG. 5 is a rear elevational view thereof on a reduced scale; and,

FIG. 6 is a bottom perspective view thereof.

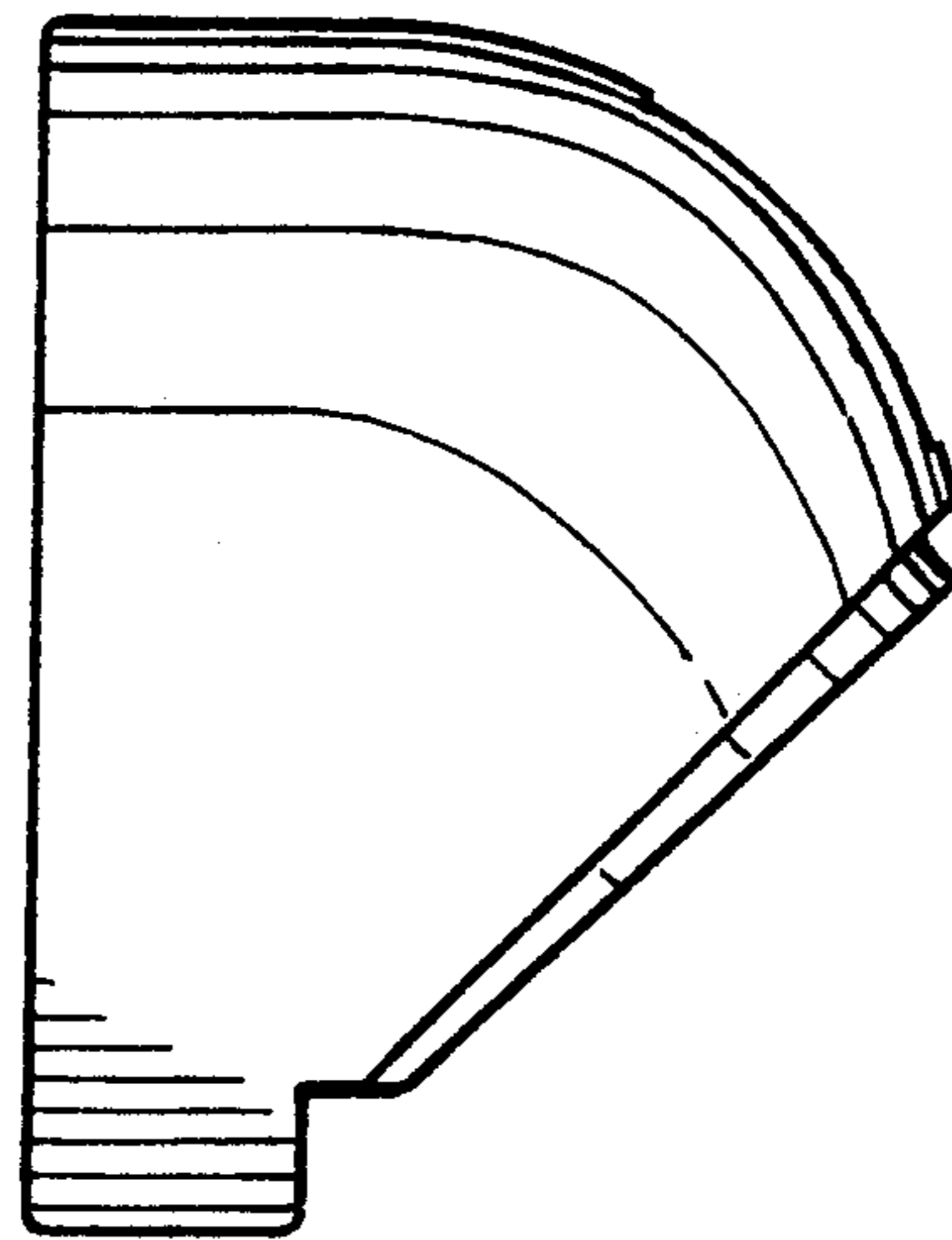
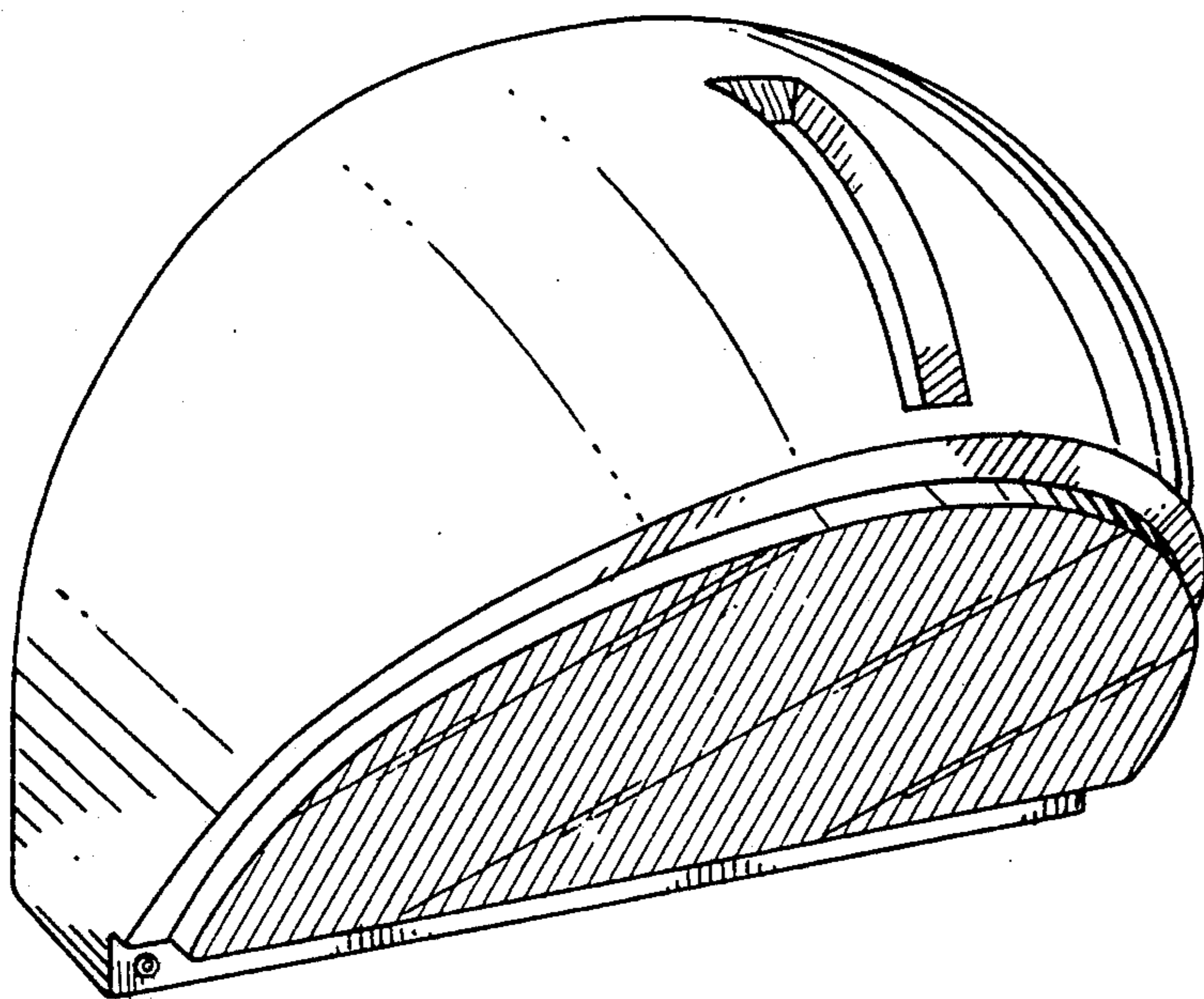

FIG. 1

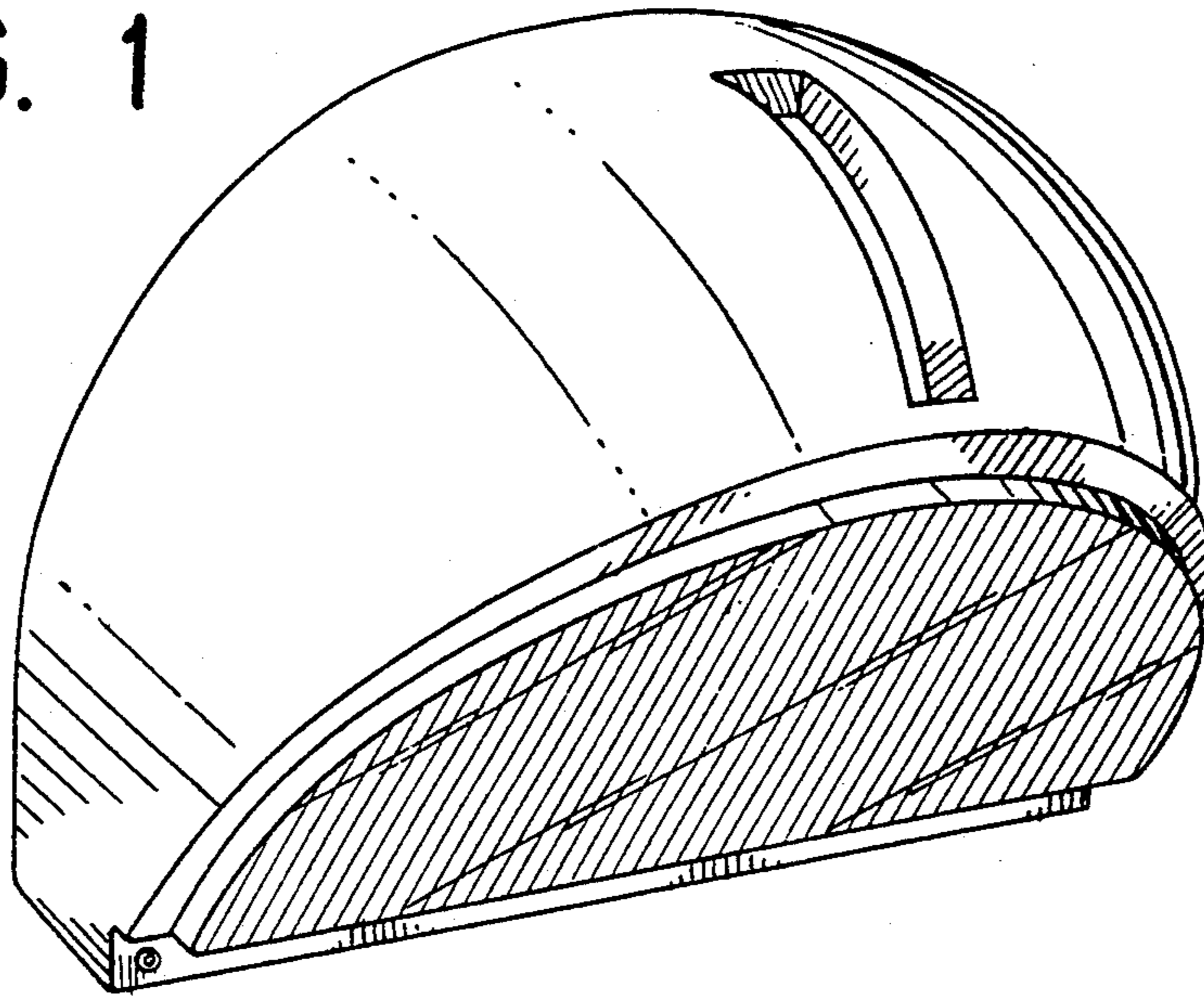

FIG. 2

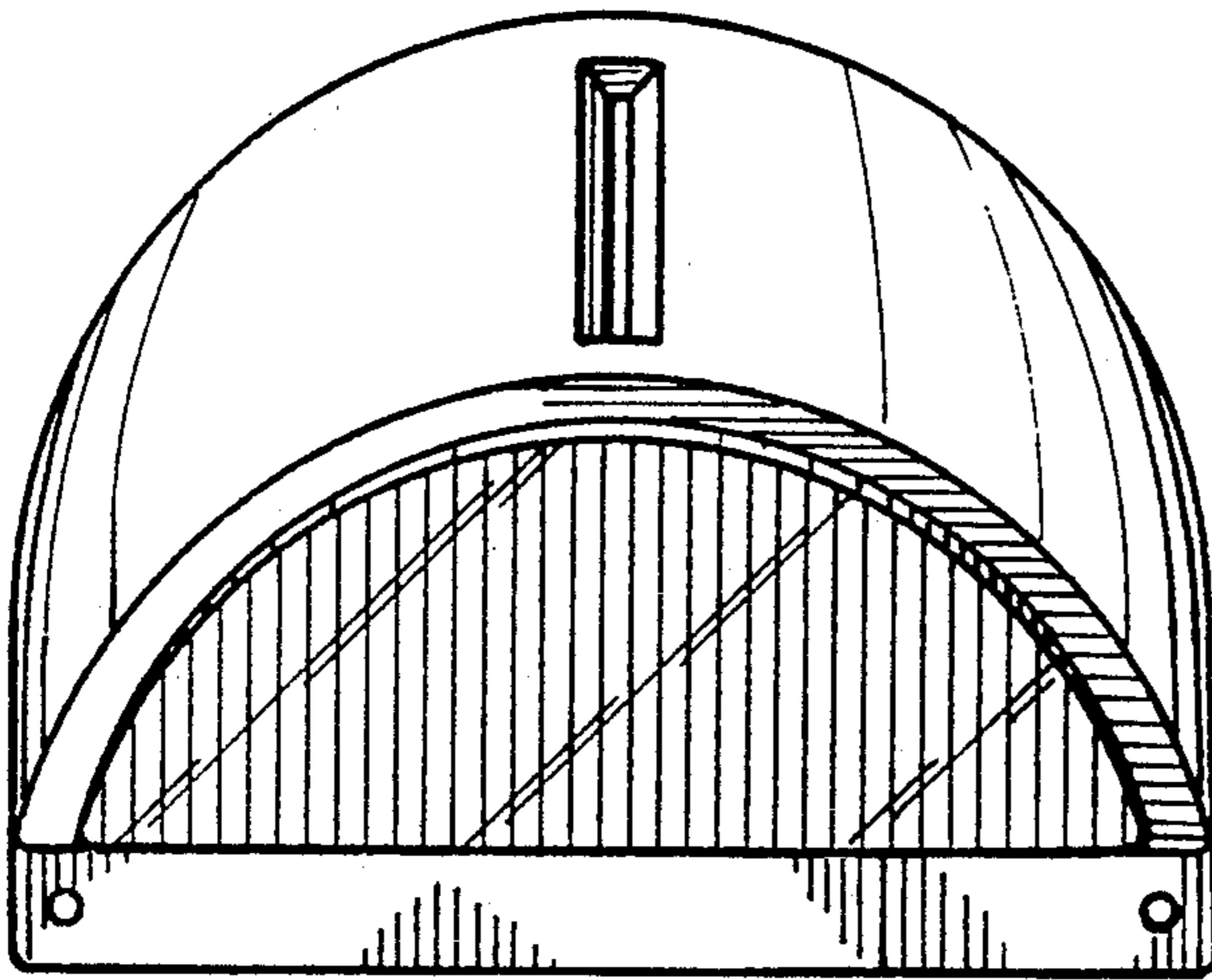

FIG. 3

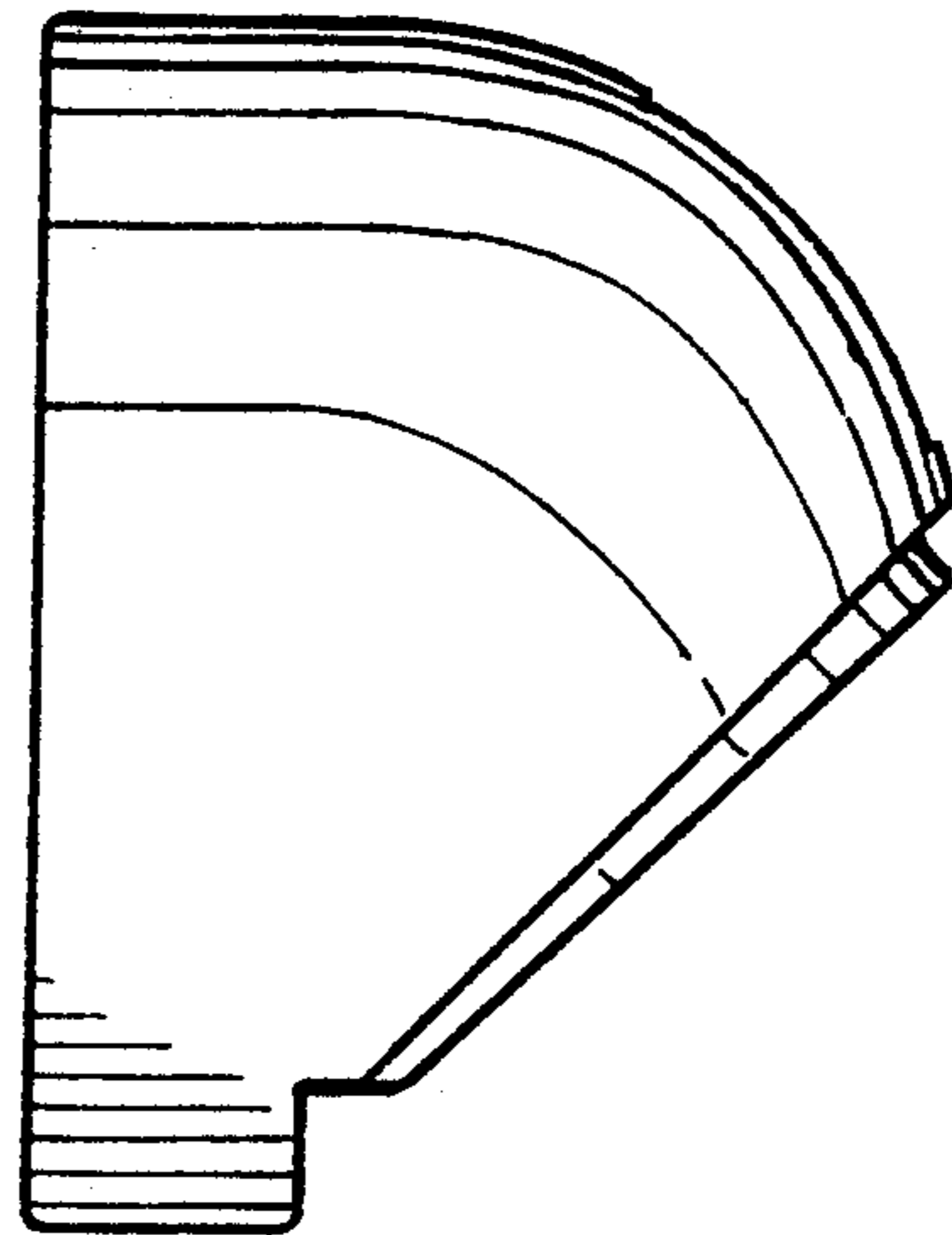

FIG. 4

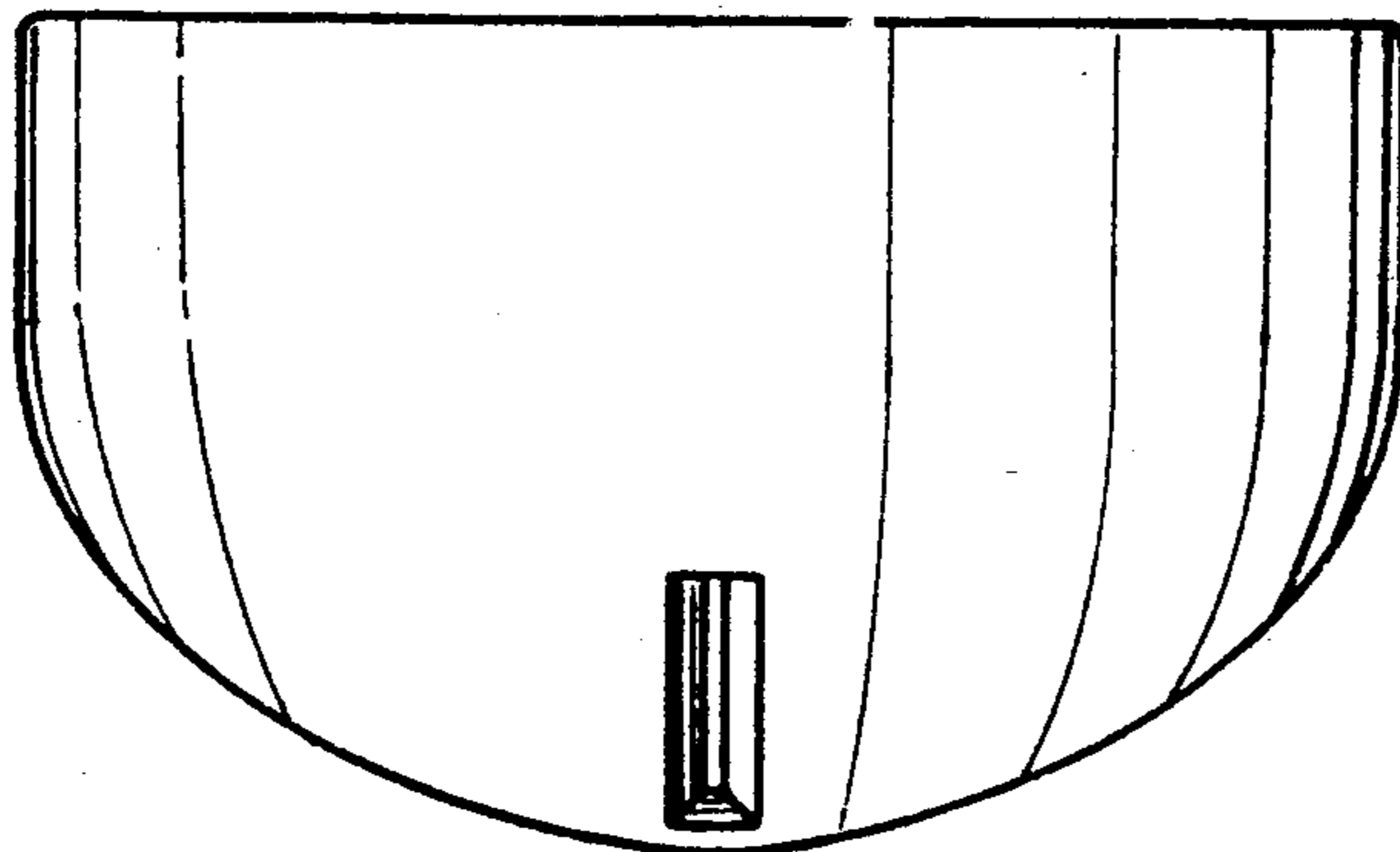

FIG. 5

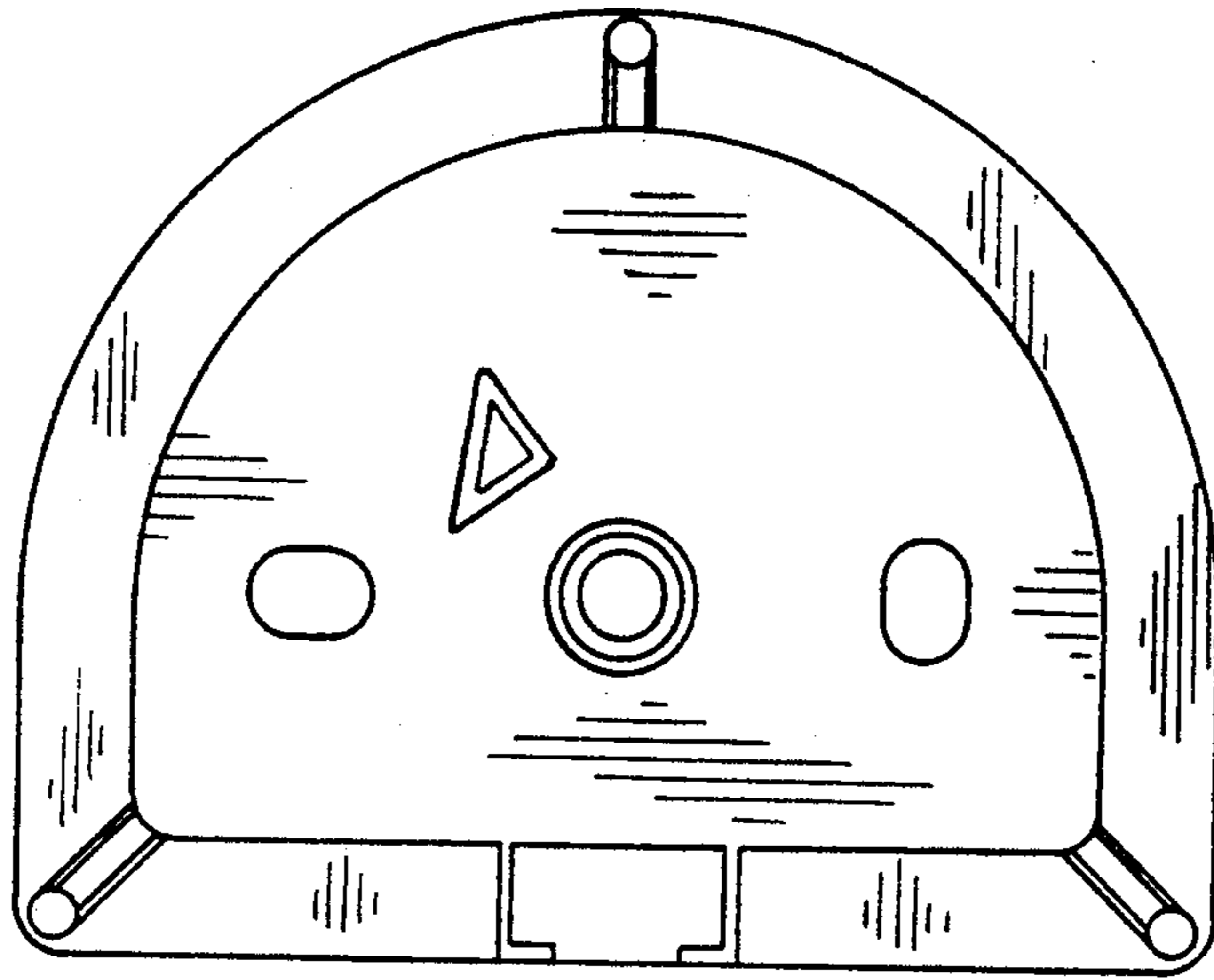

FIG. 6

