



US00D337841S

United States Patent [19]

[11] Patent Number: Des. 337,841

Lu

[45] Date of Patent: ** Jul. 27, 1993

[54] **ADJUSTABLE DESK LAMP**

3,543,019 11/1970 Jacobsen 362/413 X
4,213,591 7/1980 Jaakola 248/281.1

[76] Inventor: **James Lu**, No. 93, Sec. 1, Chungshan Rd., Hsingchuang, Taipei Hsien, Taiwan

Primary Examiner—Susan J. Lucas
Attorney, Agent, or Firm—Morton J. Rosenberg; David I. Klein

[**] Term: **14 Years**

[57] **CLAIM**

[21] Appl. No.: **767,205**

The ornamental design for an adjustable desk lamp, as shown and described.

[22] Filed: **Sep. 30, 1991**

[52] U.S. Cl. **D26/65**

[58] Field of Search **D26/61-66;**
362/269, 275, 410, 413, 418, 419, 427;
248/280.1, 281.1, 292.1

DESCRIPTION

FIG. 1 is a front, top, and left side perspective view of an adjustable desk lamp showing my new design; FIG. 2 is a front elevational view thereof; FIG. 3 is a rear elevational view thereof; FIG. 4 is a left side elevational view thereof; FIG. 5 is a right side elevational view thereof; FIG. 6 is a top plan view thereof; and, FIG. 7 is a bottom plan view thereof.

[56] **References Cited**

U.S. PATENT DOCUMENTS

D. 327,134 6/1992 Ching D26/65
D. 327,544 6/1992 Orozco D26/65

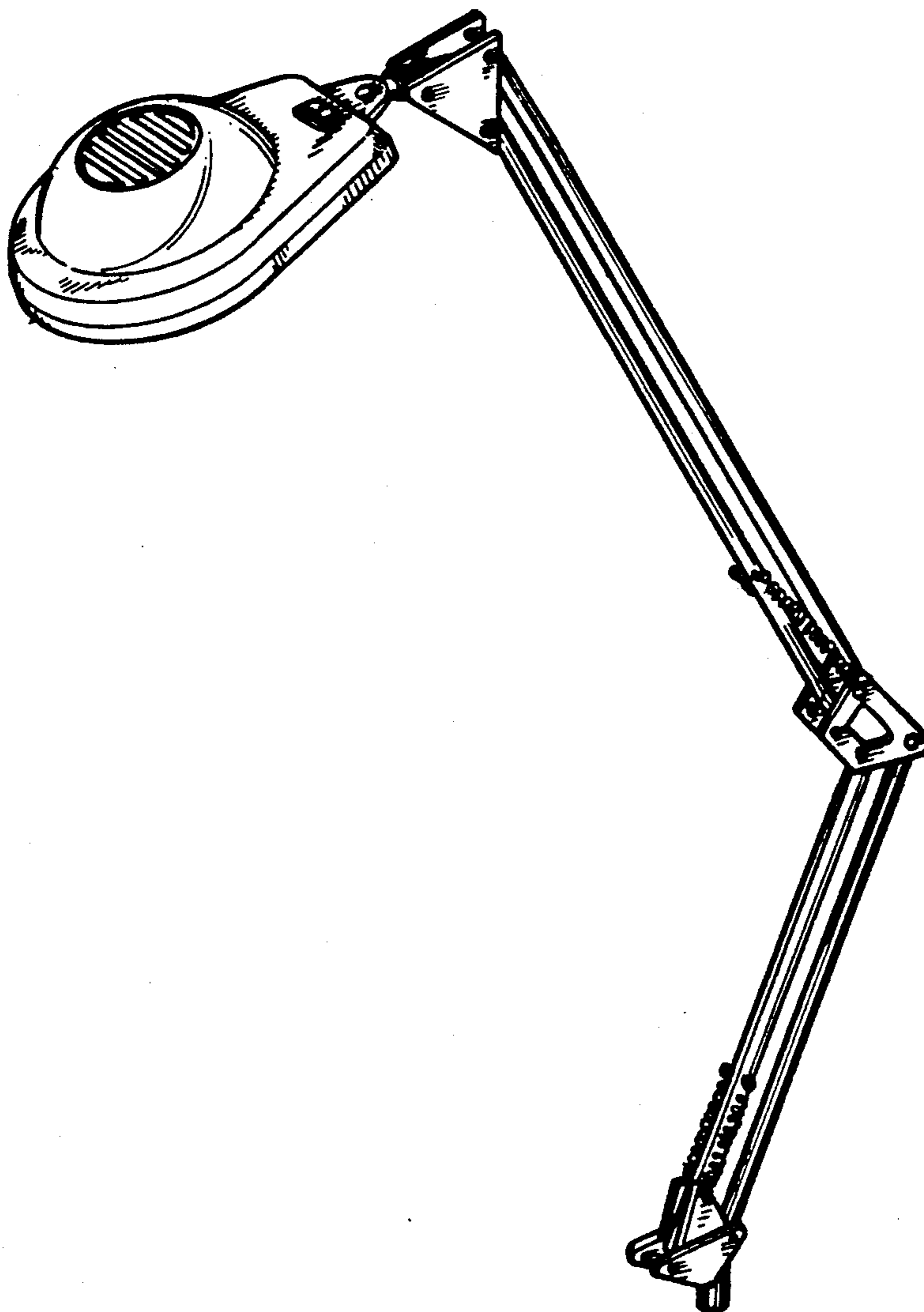

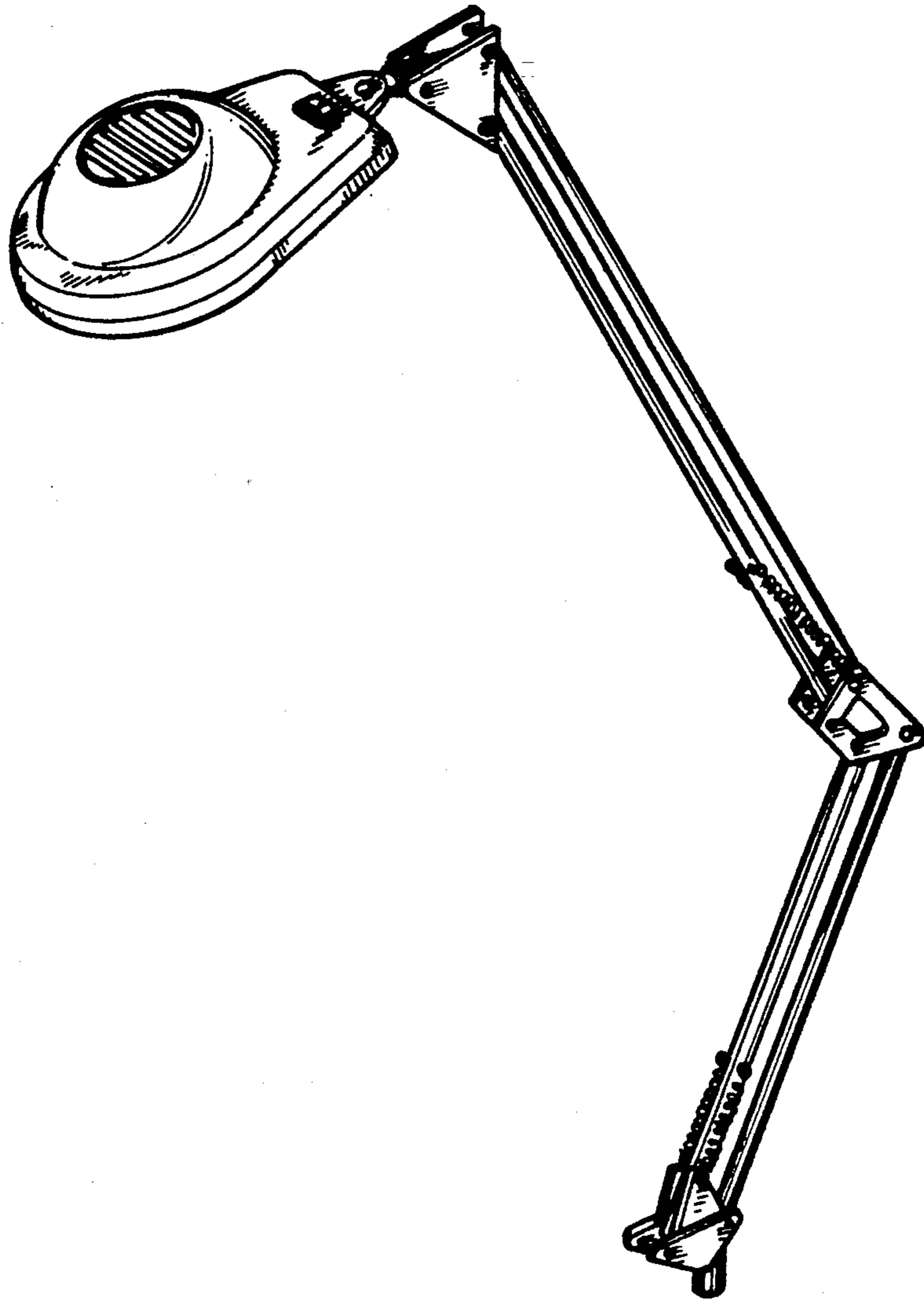

FIG. 1

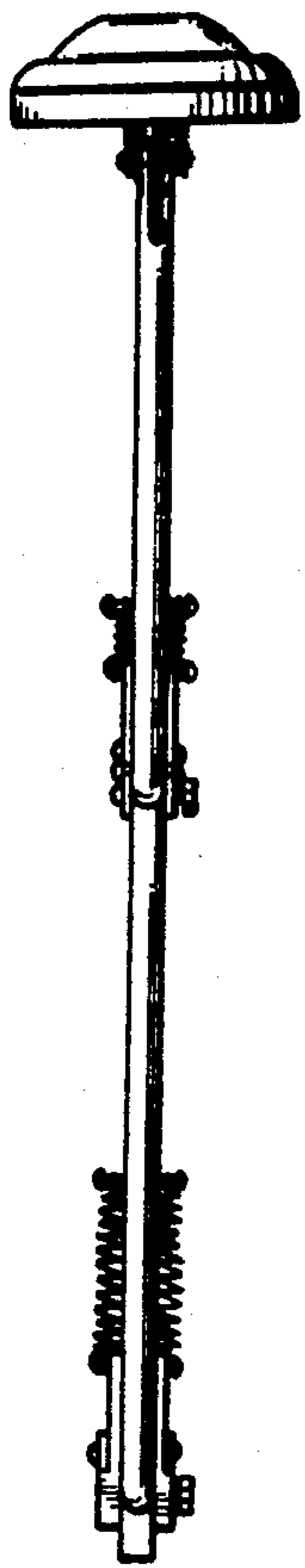

FIG. 4

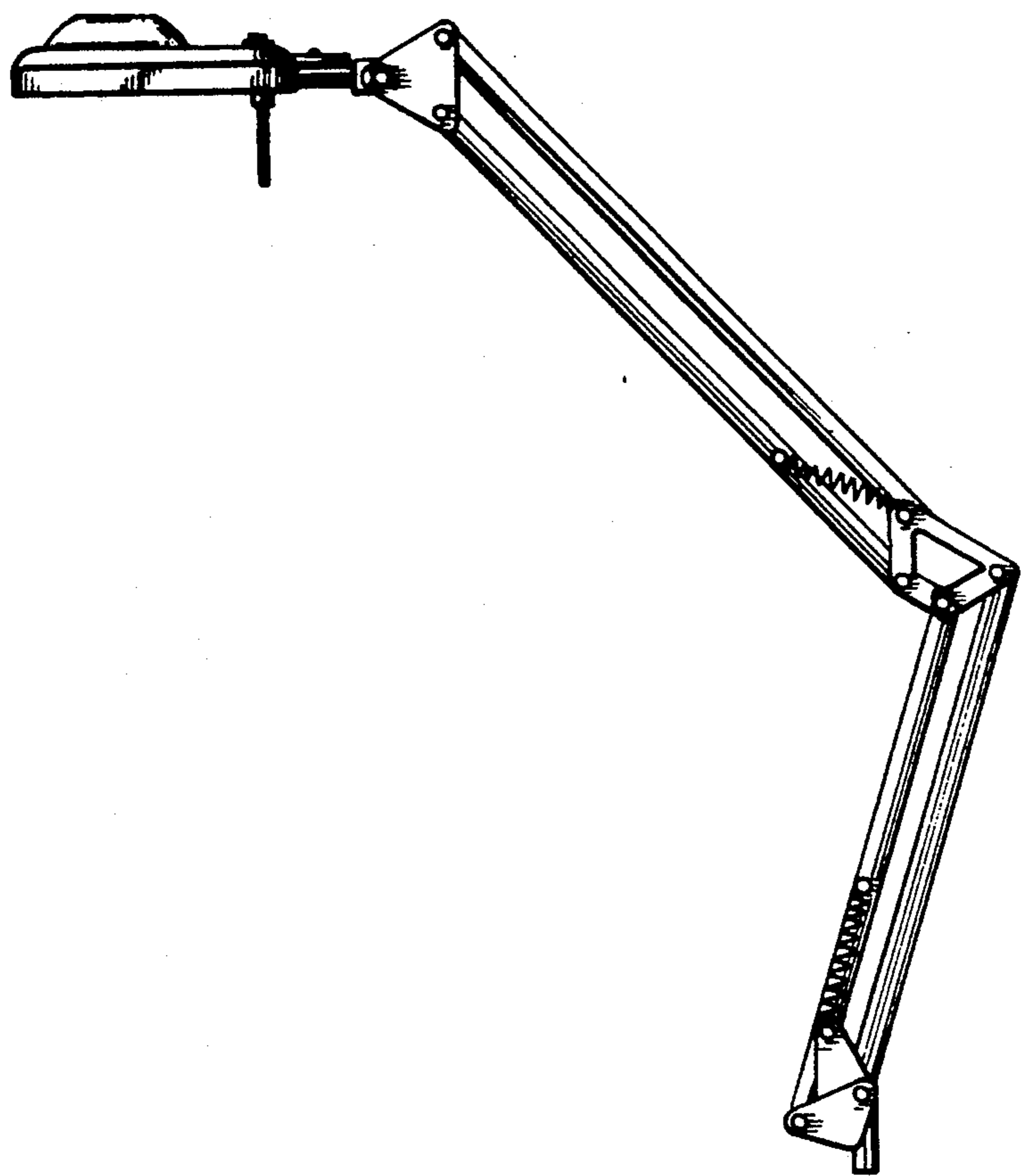

FIG. 2

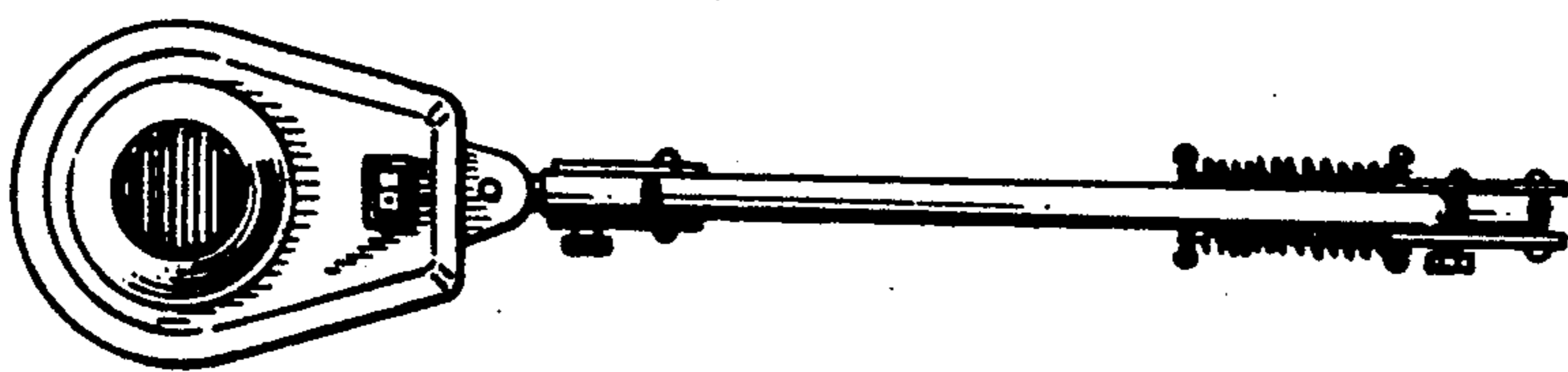

FIG. 6

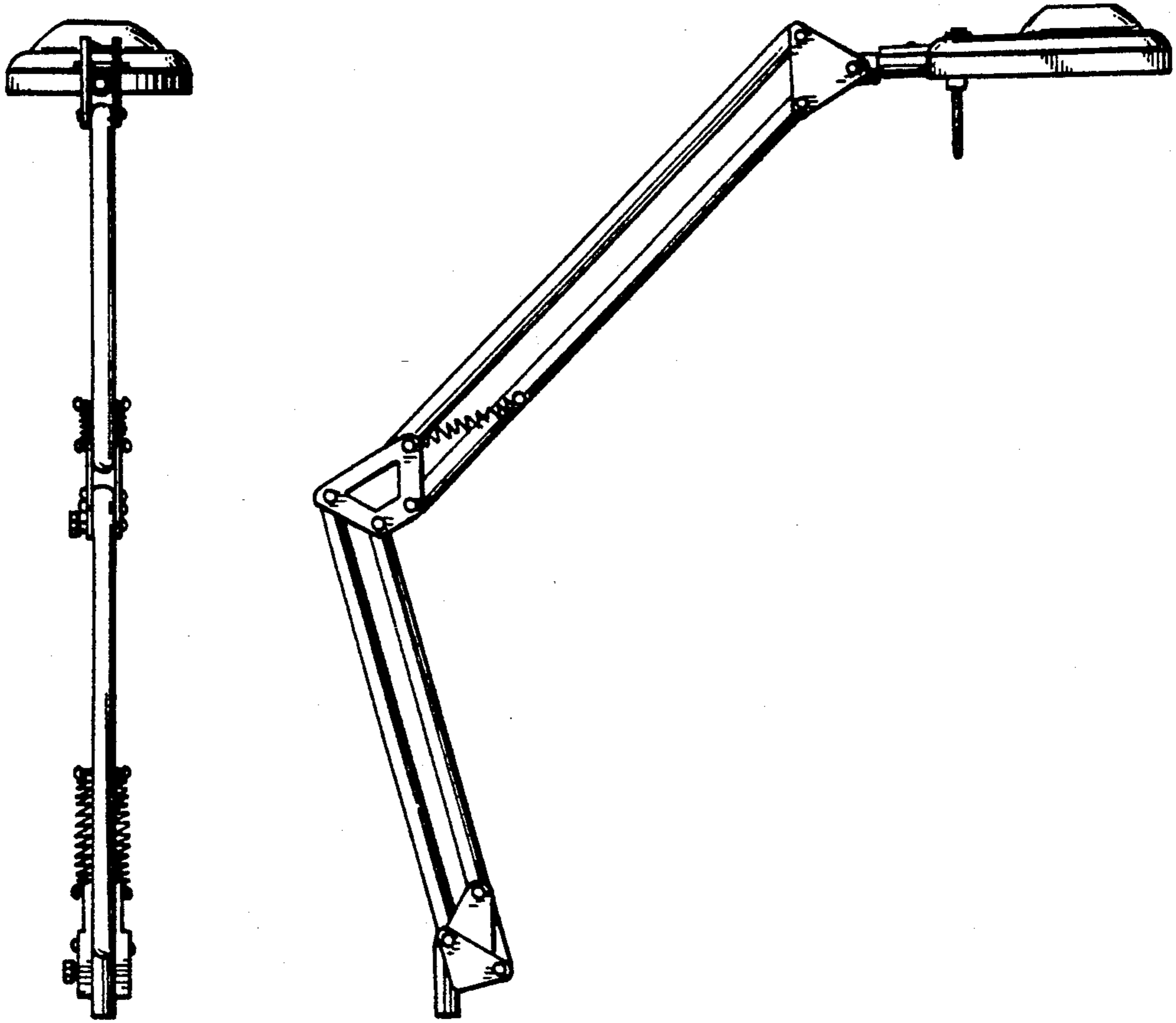

FIG. 5

FIG. 3

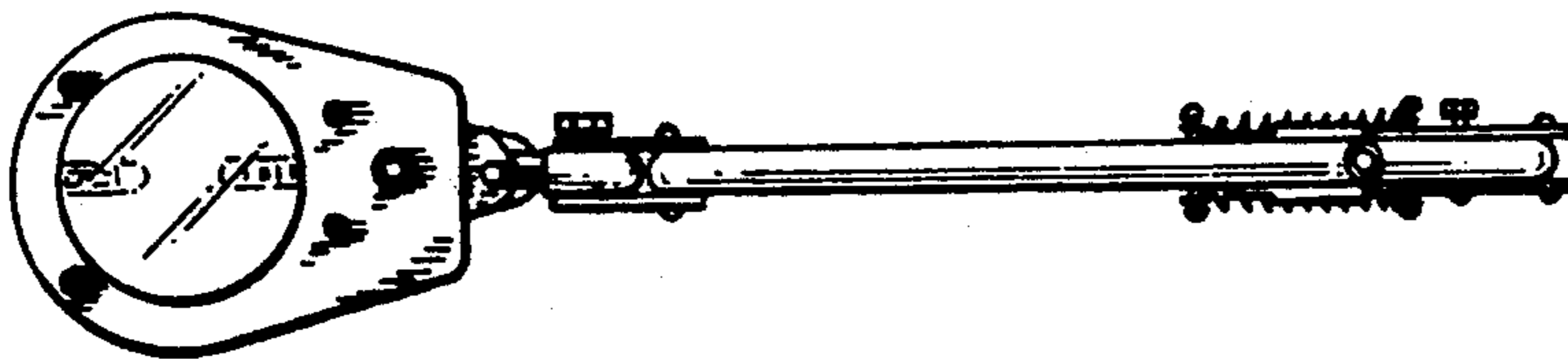

FIG. 7