



US00D337831S

United States Patent [19]

McNamara et al.

[11] Patent Number: Des. 337,831

[45] Date of Patent: ** Jul. 27, 1993

[54] **PORTABLE RESTROOM**

[75] Inventors: **George E. McNamara**, Minneapolis;
Randy R. Zenner, Brooklyn Park;
Ronald J. Holmstadt, Eden Prairie,
all of Minn.

[73] Assignee: **Satellite Industries, Inc.**,
Minneapolis, Minn.

[**] Term: **14 Years**

[21] Appl. No.: **629,198**

[22] Filed: **Dec. 18, 1990**

Related U.S. Application Data

[63] Continuation-in-part of Ser. No. 539,662, Jun. 18, 1990,
abandoned.

[52] U.S. Cl. **D25/16**

[58] Field of Search **D25/16, 48; 52/282,**
52/236.1, 285; 4/460, 459, 462, 475, 612

[56] **References Cited**

U.S. PATENT DOCUMENTS

- D. 248,775 8/1978 Brown D25/16
- D. 250,350 11/1978 Sargent et al. D25/16
- D. 258,464 3/1981 Garst D25/16
- D. 275,520 9/1984 Harding et al. D25/16
- D. 282,782 2/1986 Juairé et al. D25/48
- D. 288,718 3/1987 Juairé et al. D25/48
- 1,054,317 2/1913 Sawyer D25/16 X
- 3,263,379 8/1966 Cisco .
- 3,447,716 6/1969 Harding .
- 3,835,480 9/1974 Harding D25/16 X
- 4,065,885 1/1978 Blick, III et al. 52/282
- 4,080,076 3/1978 Borghi .
- 4,305,164 12/1981 Sargent et al. 4/460
- 4,493,118 1/1985 Braxton D25/16 X
- 4,532,915 8/1985 de Rham .
- 4,577,351 3/1986 Harding 52/282
- 4,831,671 5/1989 Harding D25/16

Primary Examiner—A. Hugo Word
Assistant Examiner—Doris V. Coles

Attorney, Agent, or Firm—Robert A. Elwell; Harold D. Jastram

[57] **CLAIM**

The ornamental design for a portable restroom, as shown and described.

DESCRIPTION

FIG. 1 is a perspective view of a portable restroom showing our new design;
 FIG. 2 is a top plan view thereof, the bottom plan being plain and unadorned;
 FIG. 3 is a front view thereof;
 FIG. 4 is a right side view thereof;
 FIG. 5 is a left side view thereof;
 FIG. 6 is a rear view thereof;
 FIG. 7 is a perspective view of a portable restroom showing another embodiment of our new design;
 FIG. 8 is a top plan view of the embodiment of FIG. 7, the bottom plan being plain and unadorned;
 FIG. 9 is a front view of the embodiment of FIG. 7;
 FIG. 10 is a left side view of the embodiment of FIG. 7;
 FIG. 11 is a right side view of the embodiment of FIG. 7;
 FIG. 12 is a rear view of the embodiment of FIG. 7;
 FIG. 13 is a perspective view of another embodiment of our new design;
 FIG. 14 is a top plan view of the embodiment of FIG. 13, the bottom plan being plain and unadorned;
 FIG. 15 is a front view of the embodiment of FIG. 13;
 FIG. 16 is a right side view of the embodiment of FIG. 13;
 FIG. 17 is a left side view of the embodiment of FIG. 13;
 FIG. 18 is a rear view of the embodiment of FIG. 13;
 FIG. 19 is a perspective view of the embodiment of FIG. 13 with a portion cut away to reveal interior design;
 FIG. 20 is a perspective view of the embodiment of FIG. 13 with open door revealing interior design;
 FIG. 21 is a perspective view of the embodiment of FIG. 13 with open door and a portion cut away to reveal interior design; and,
 FIG. 22 is a sectional view at 22—22 of FIG. 15.

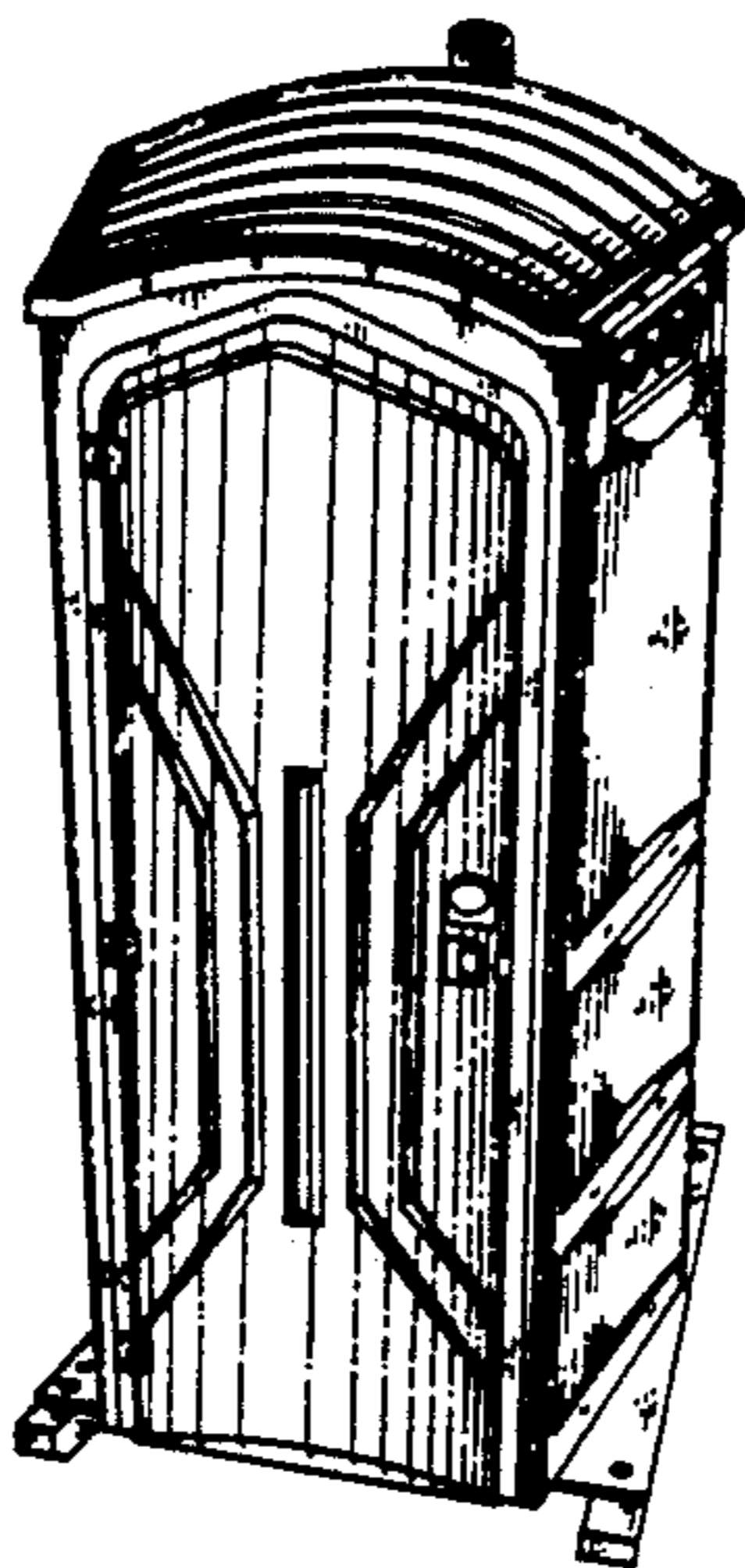

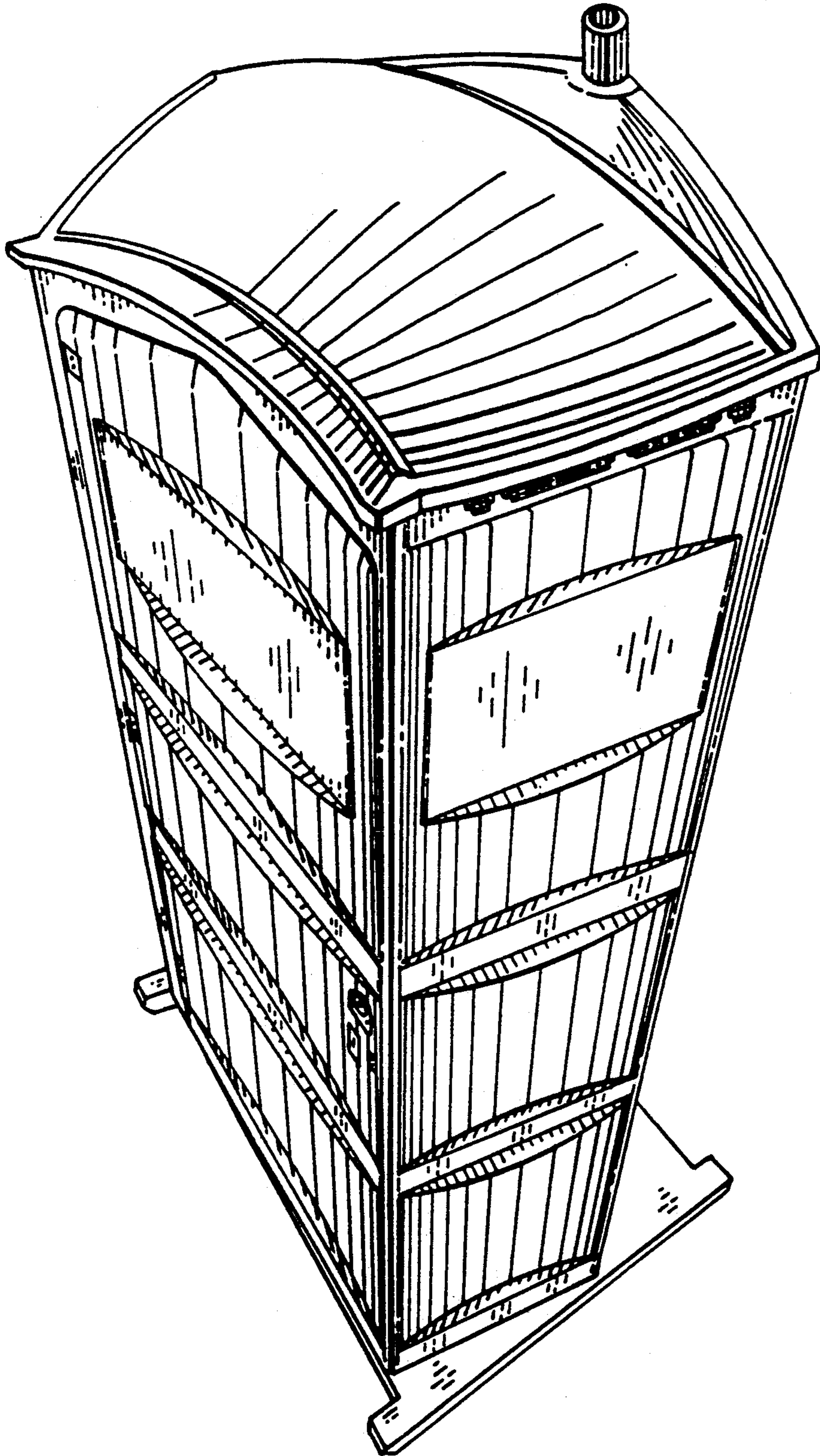

FIG. 1

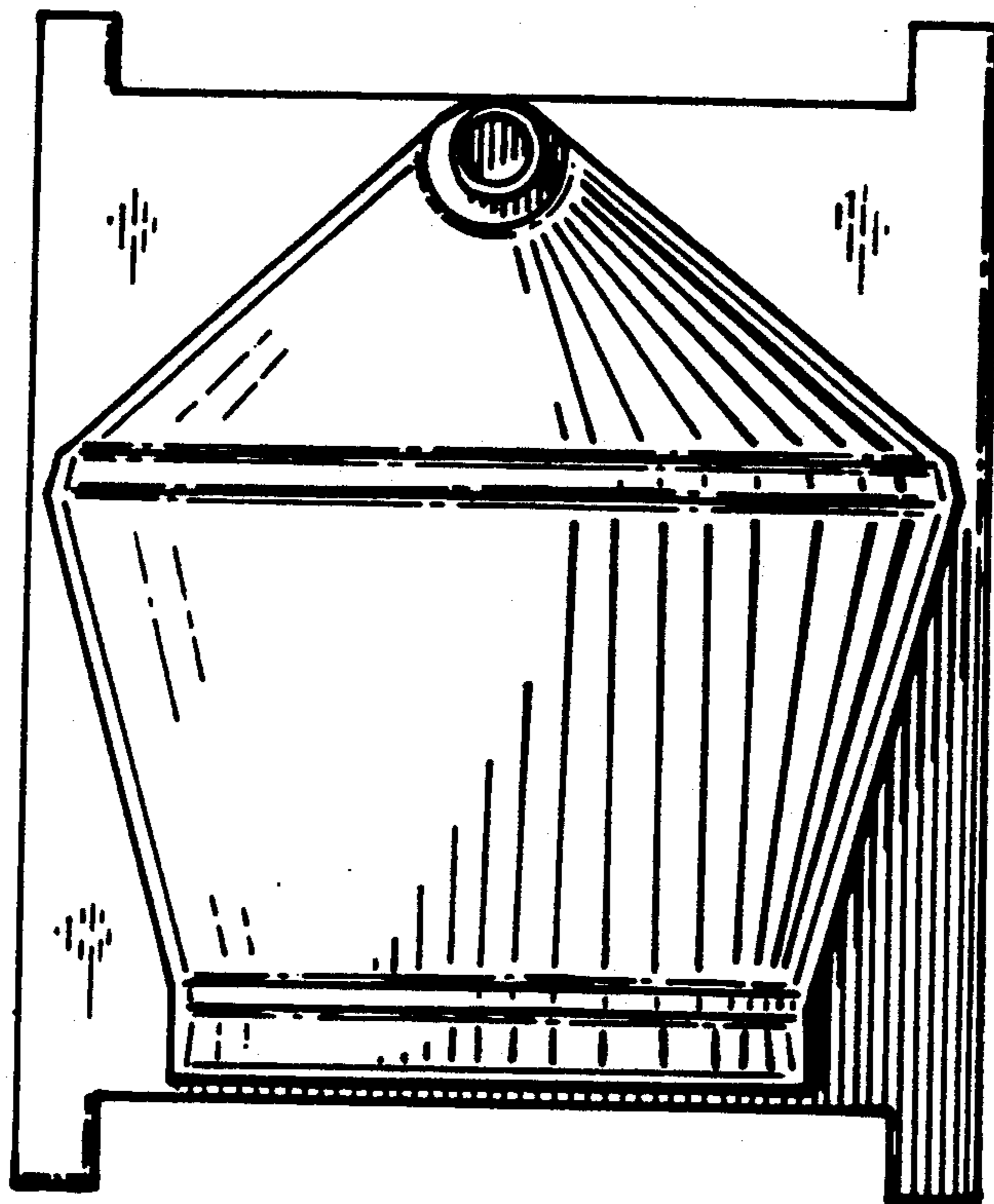

FIG. 2

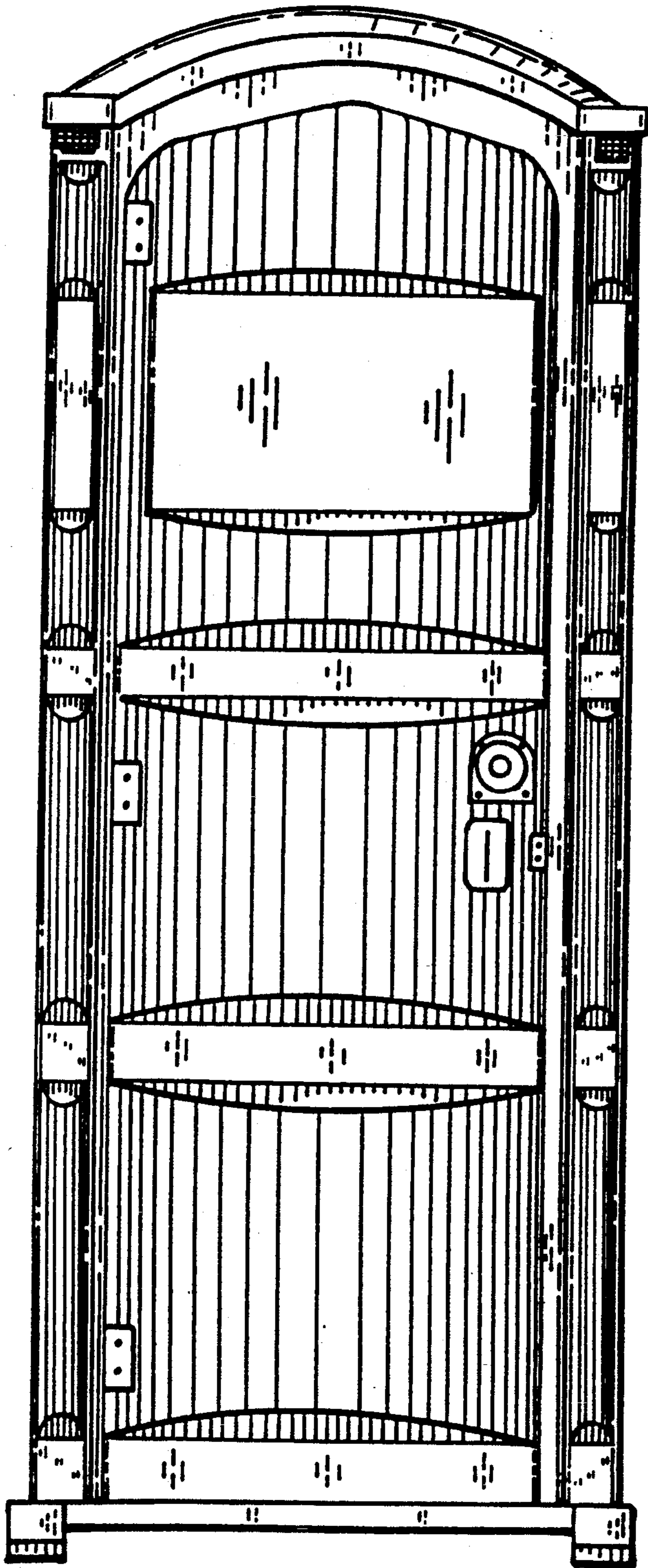

FIG. 3

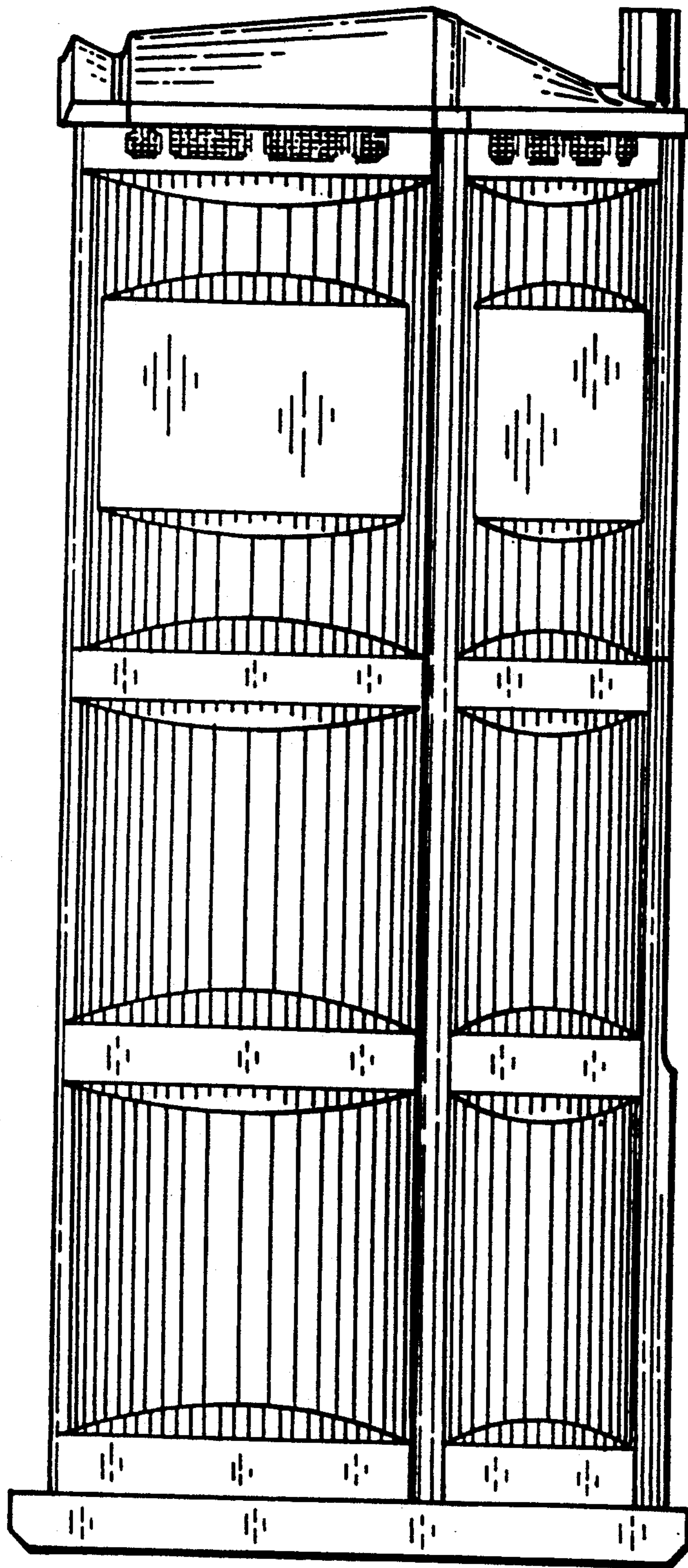

FIG. 4

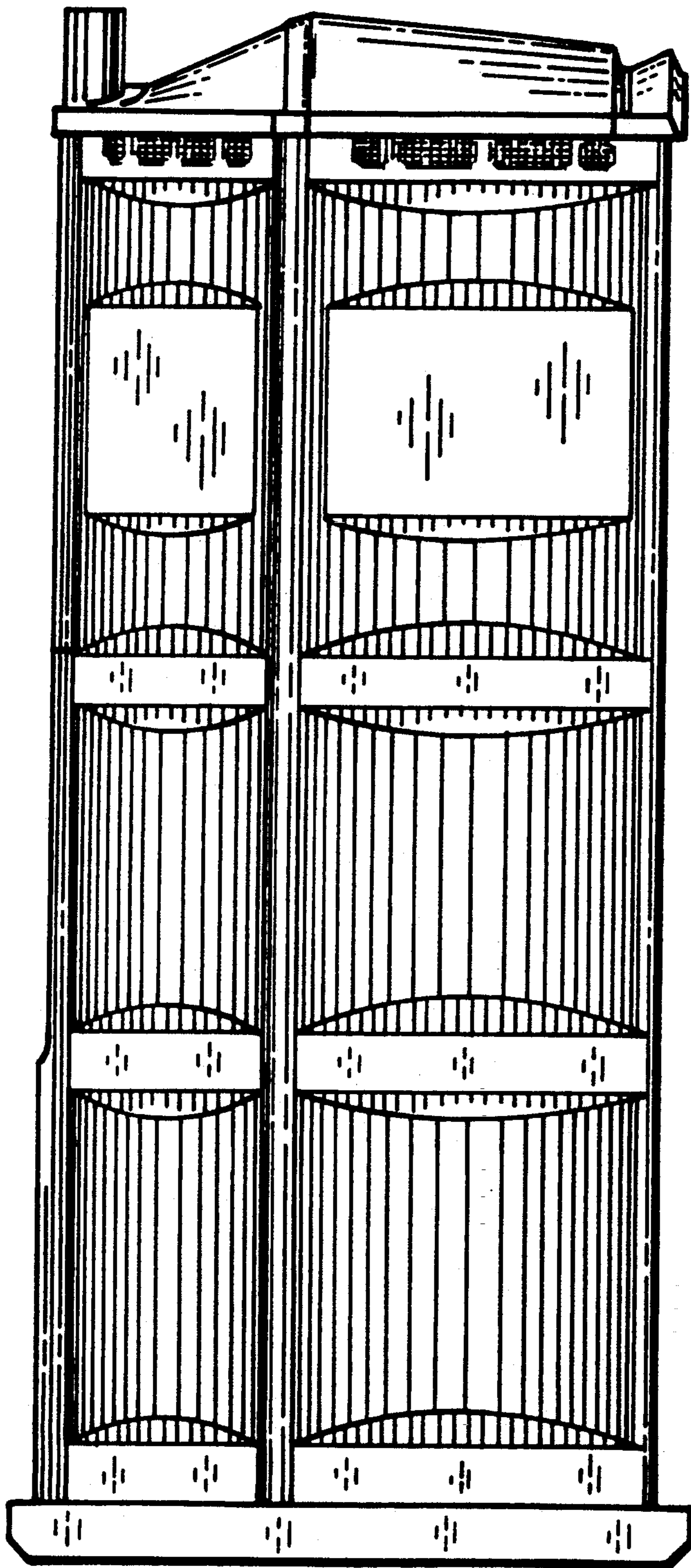

FIG. 5

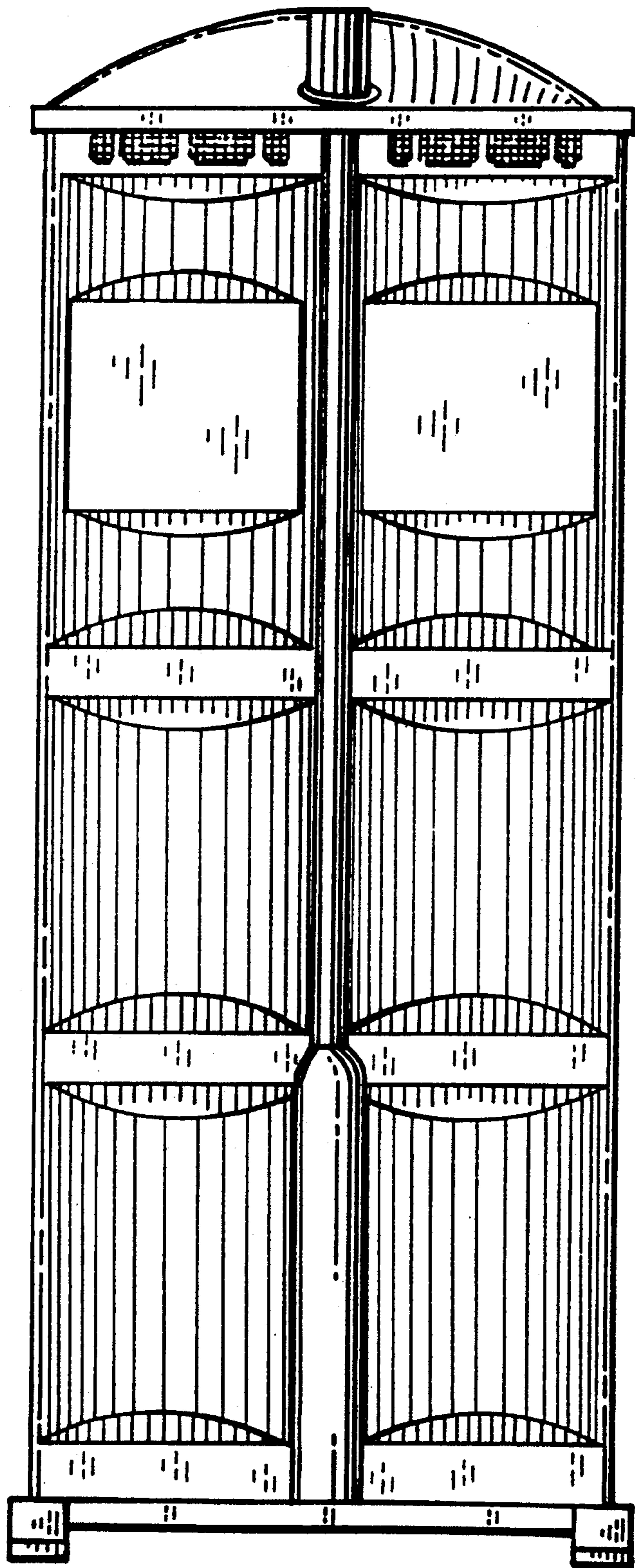

FIG. 6

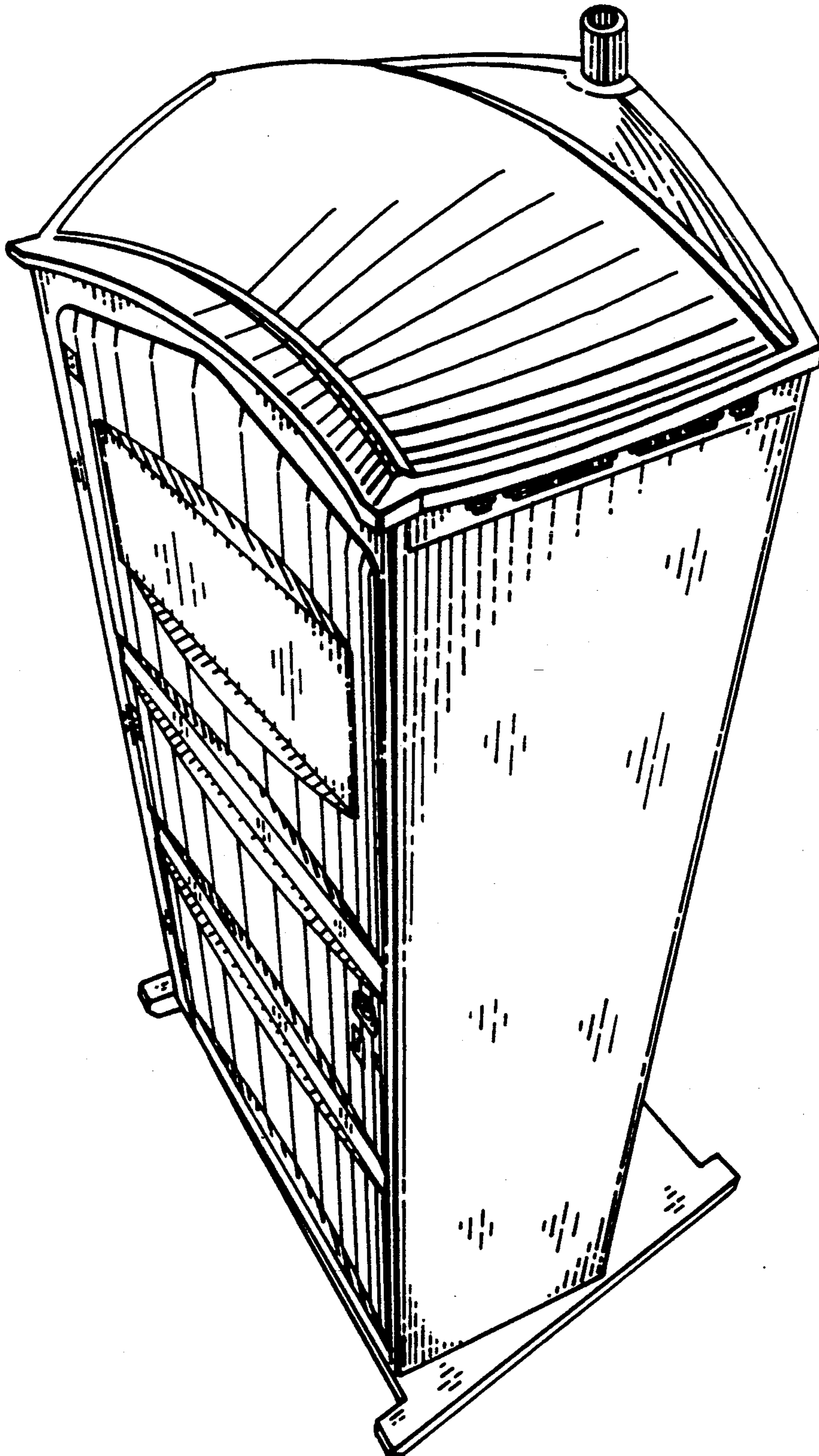

FIG. 7

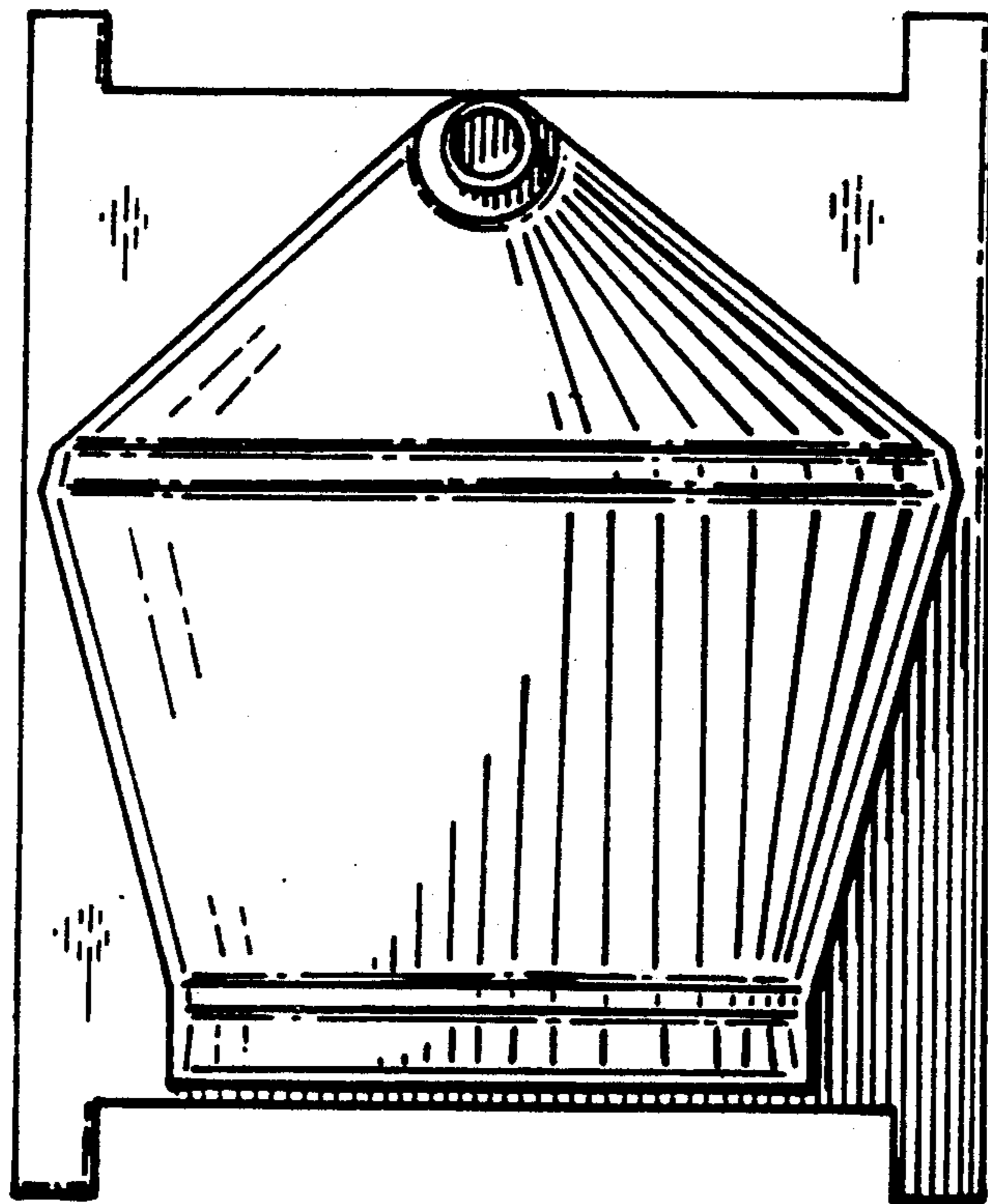

FIG. 8

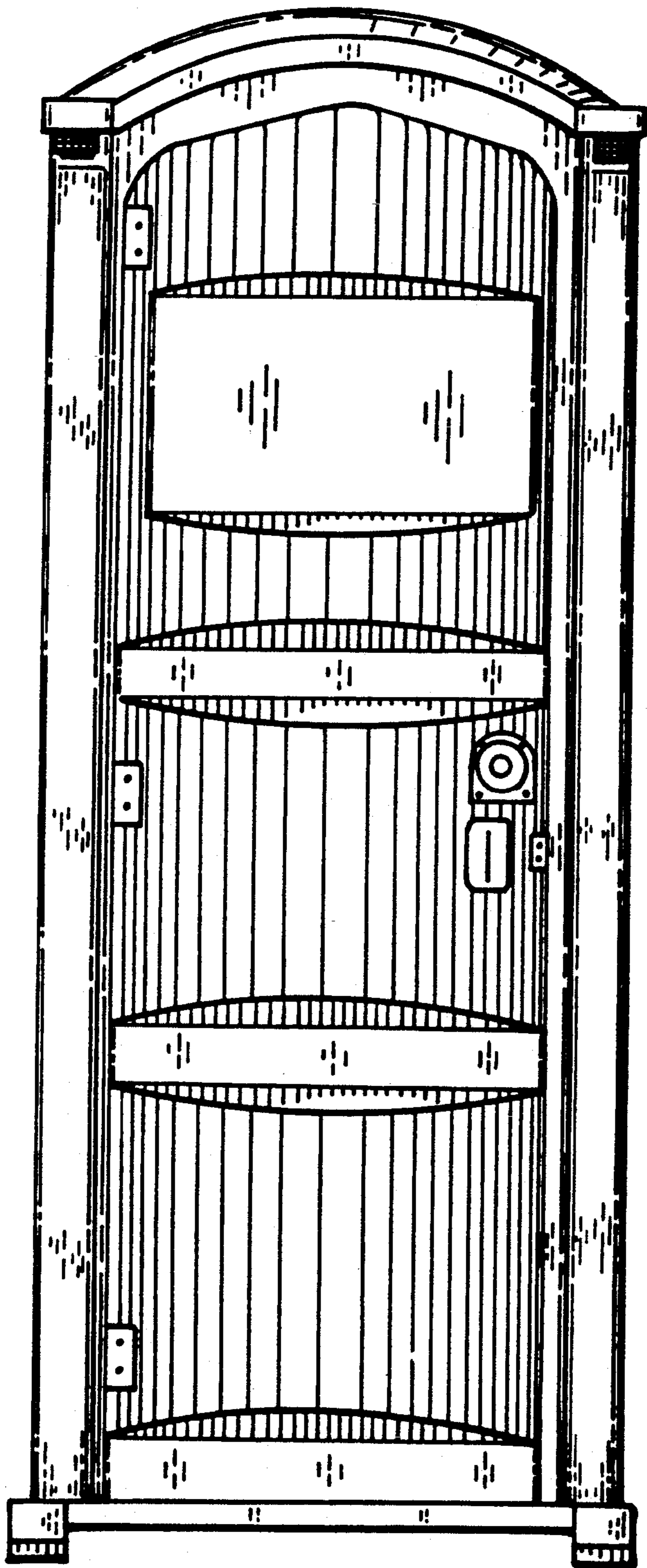

FIG. 9

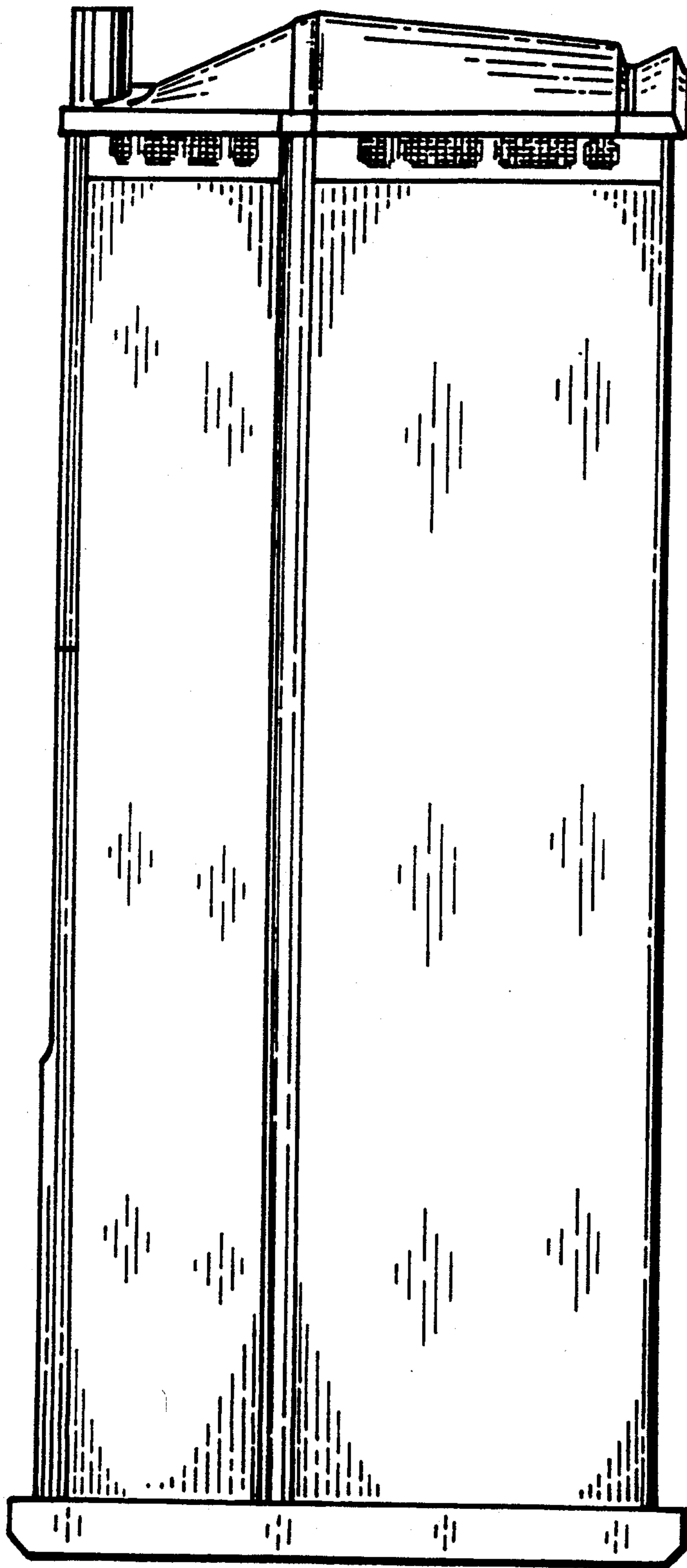

FIG. 10

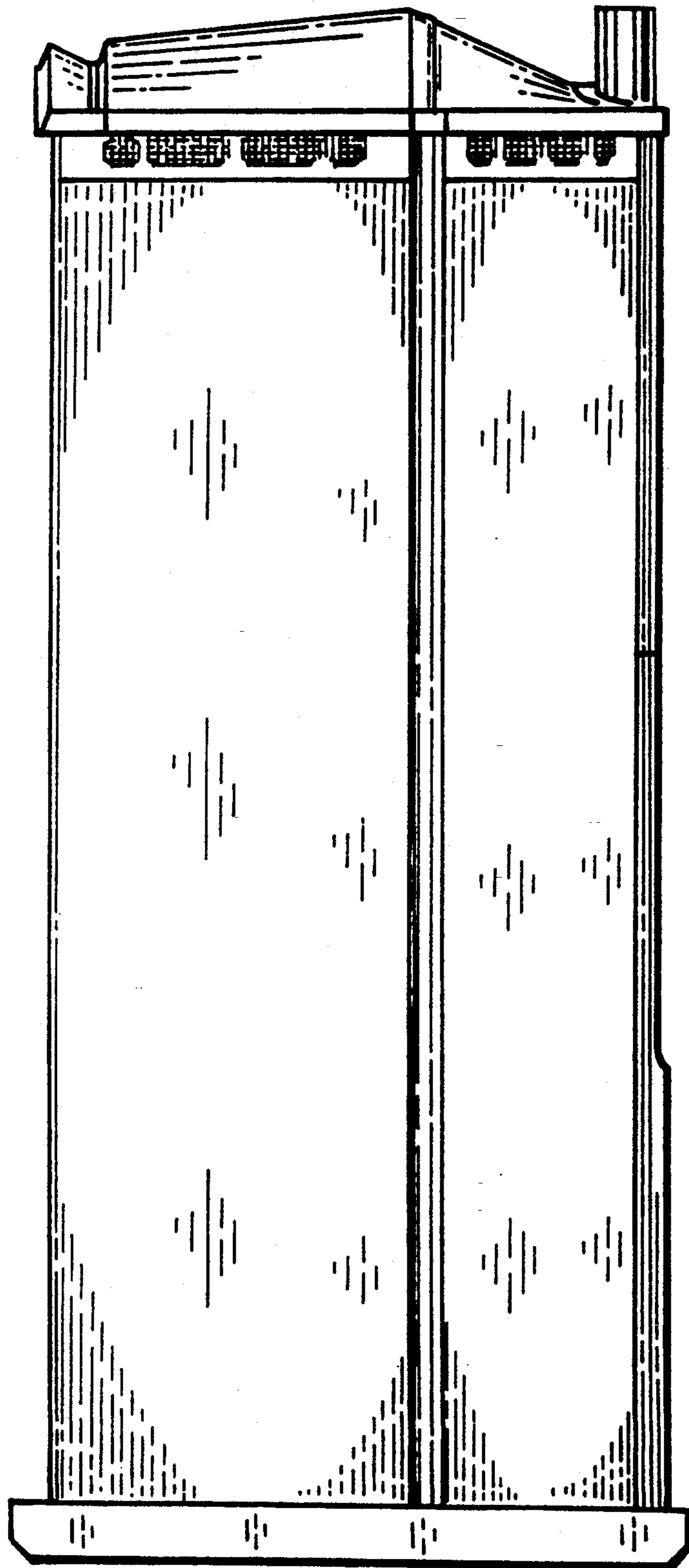

FIG. II

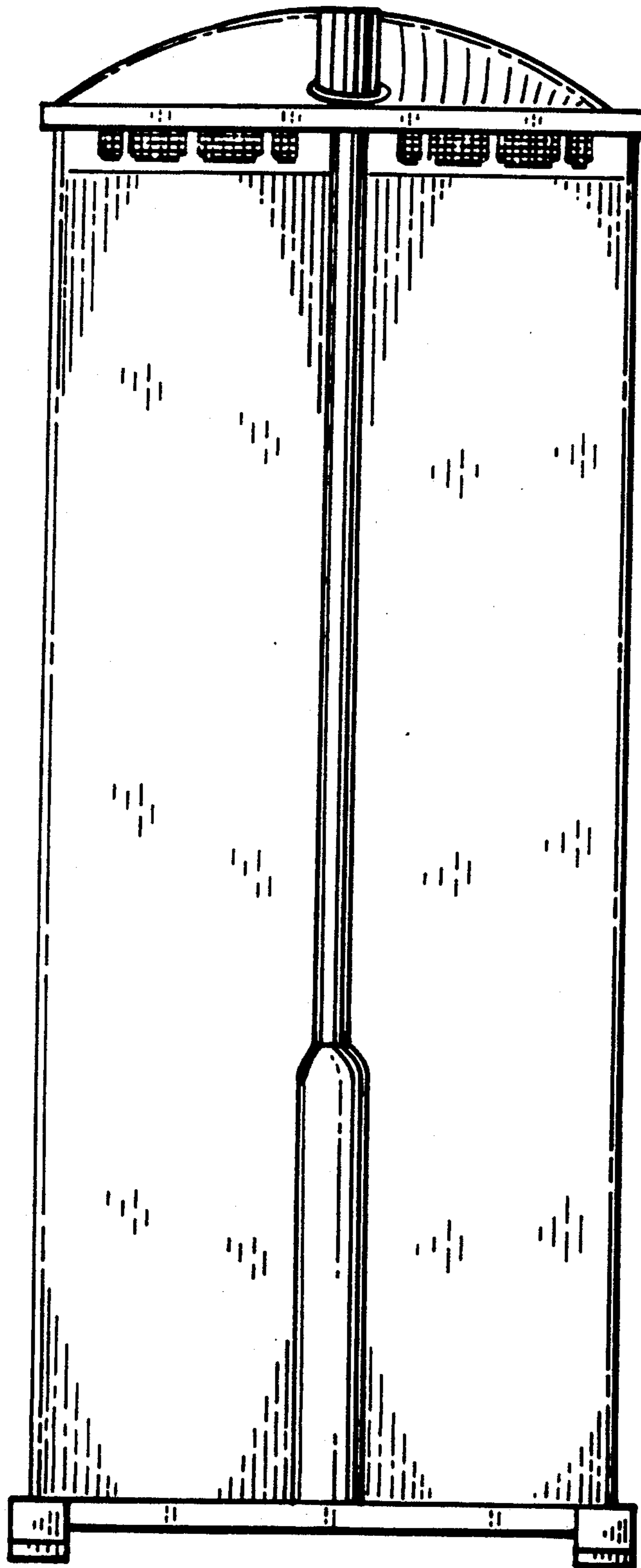

FIG. 12

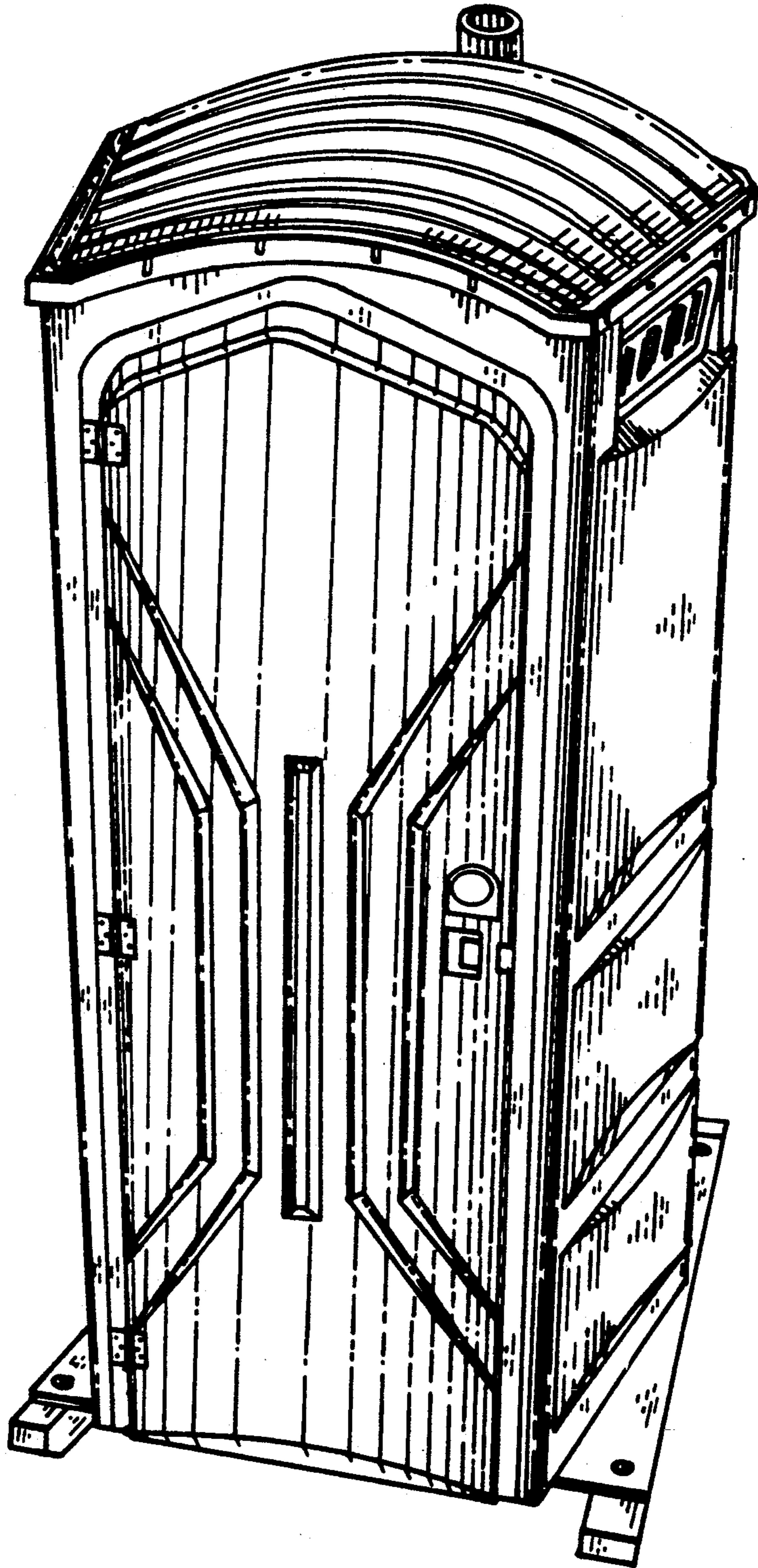

FIG. 13

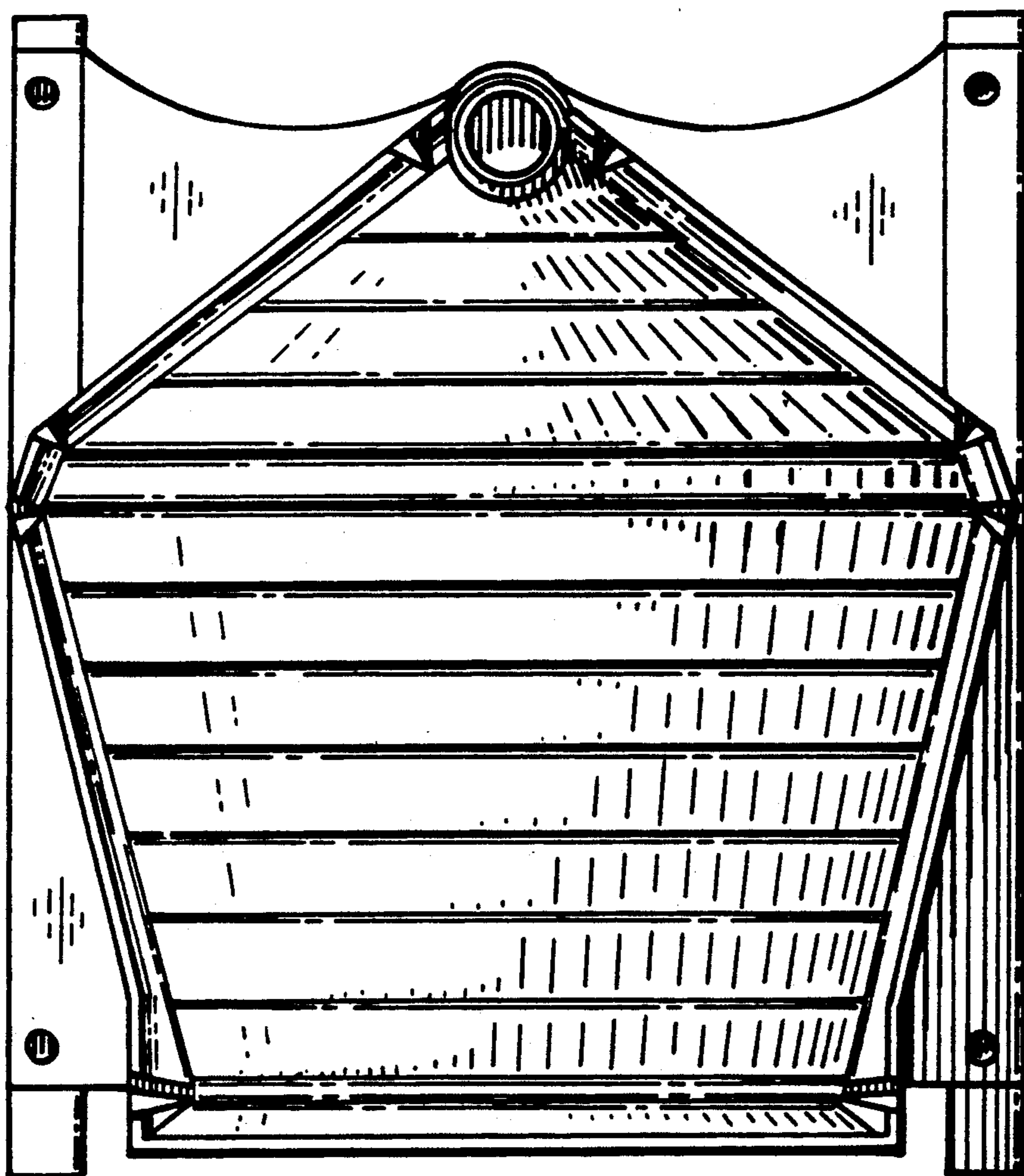

FIG. 14

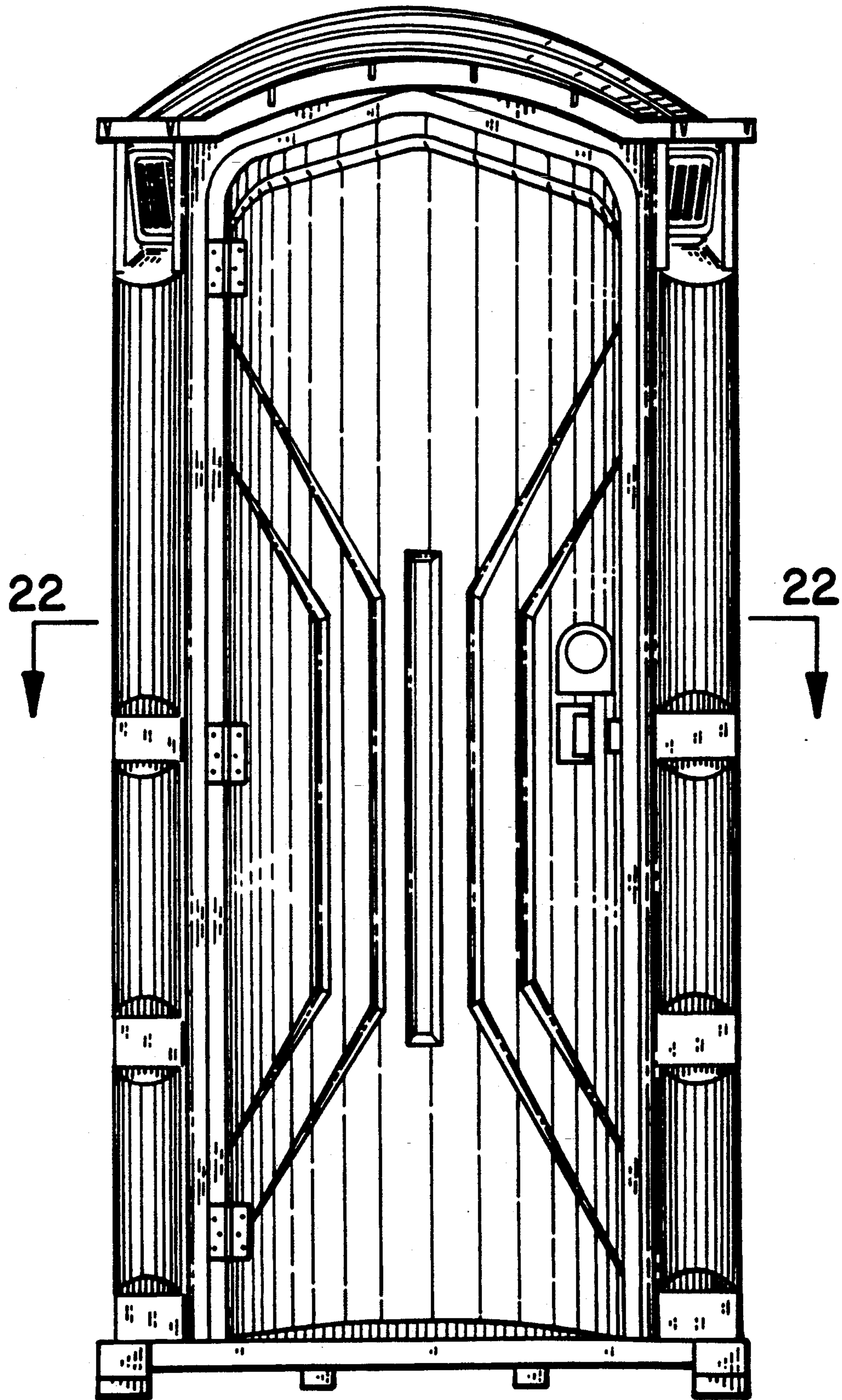

FIG. 15

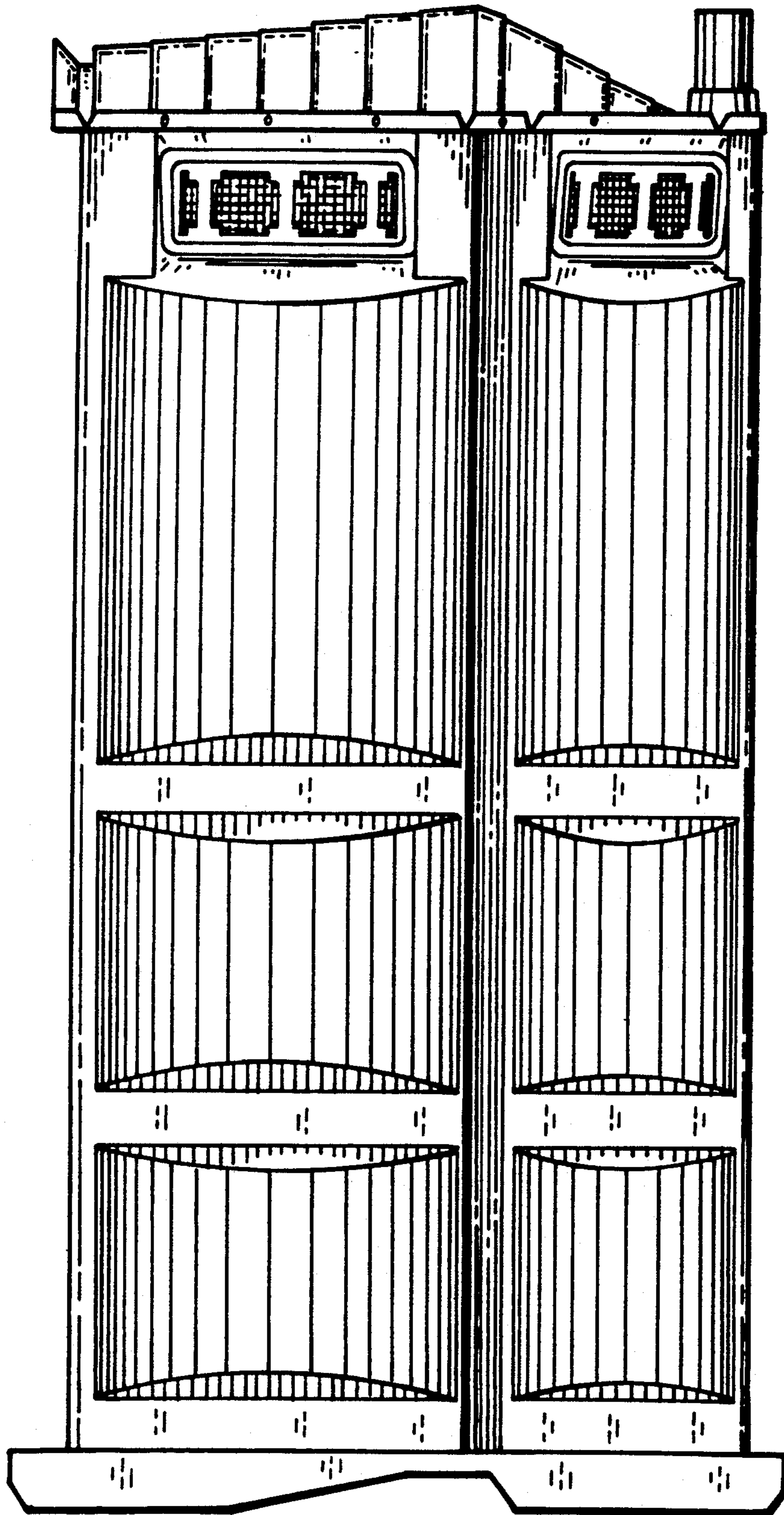

FIG. 16

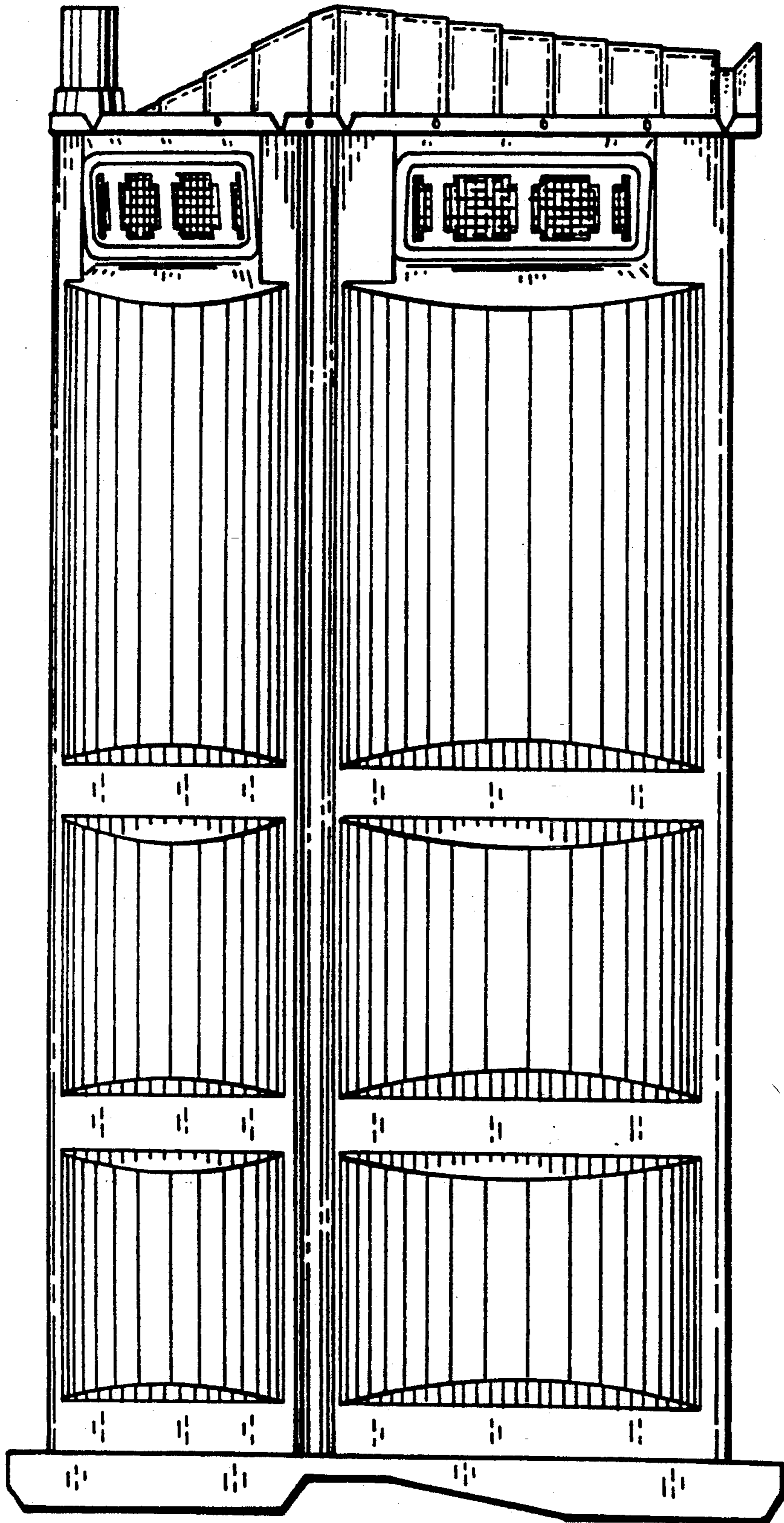

FIG. 17

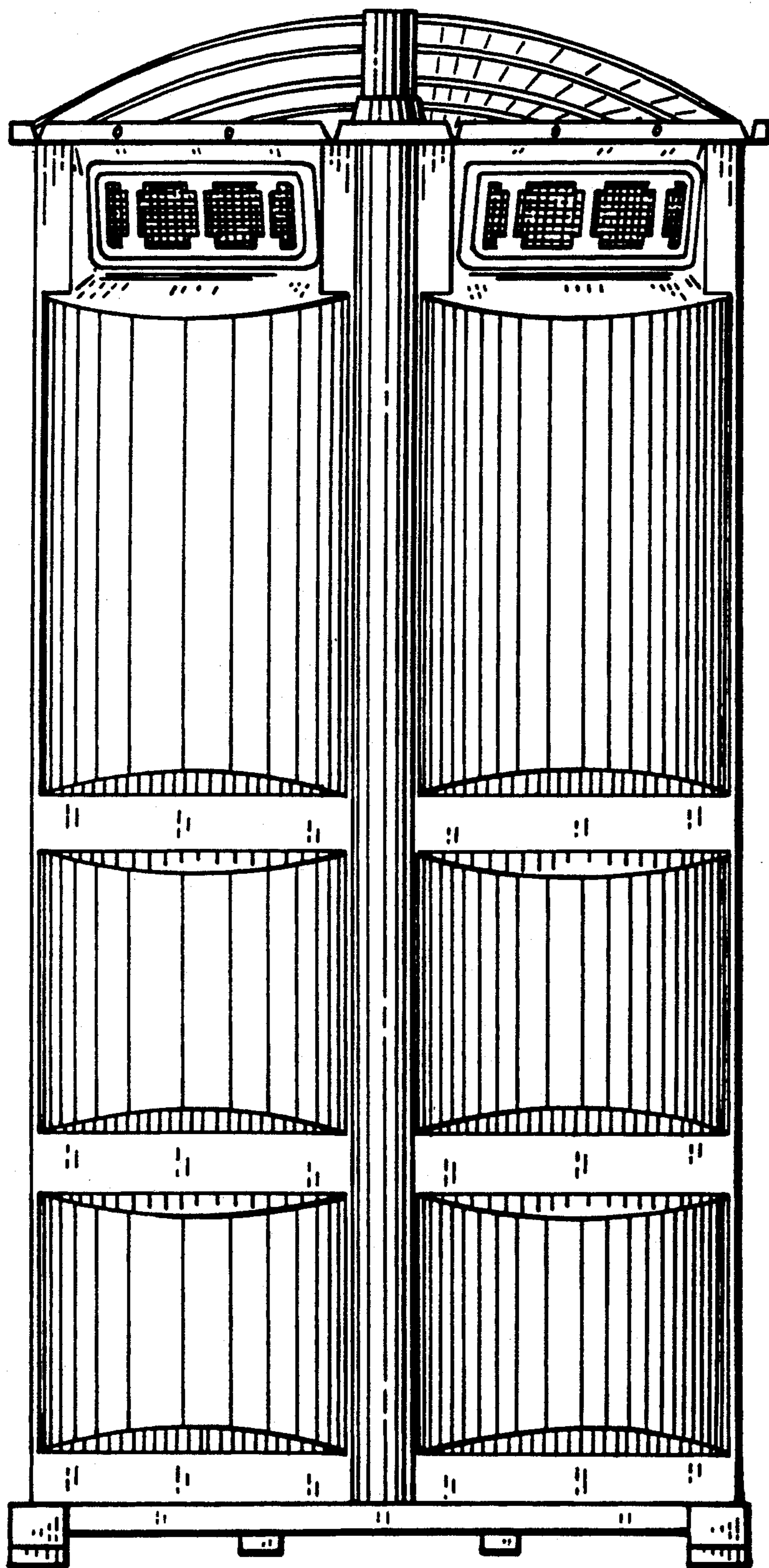

FIG. 18

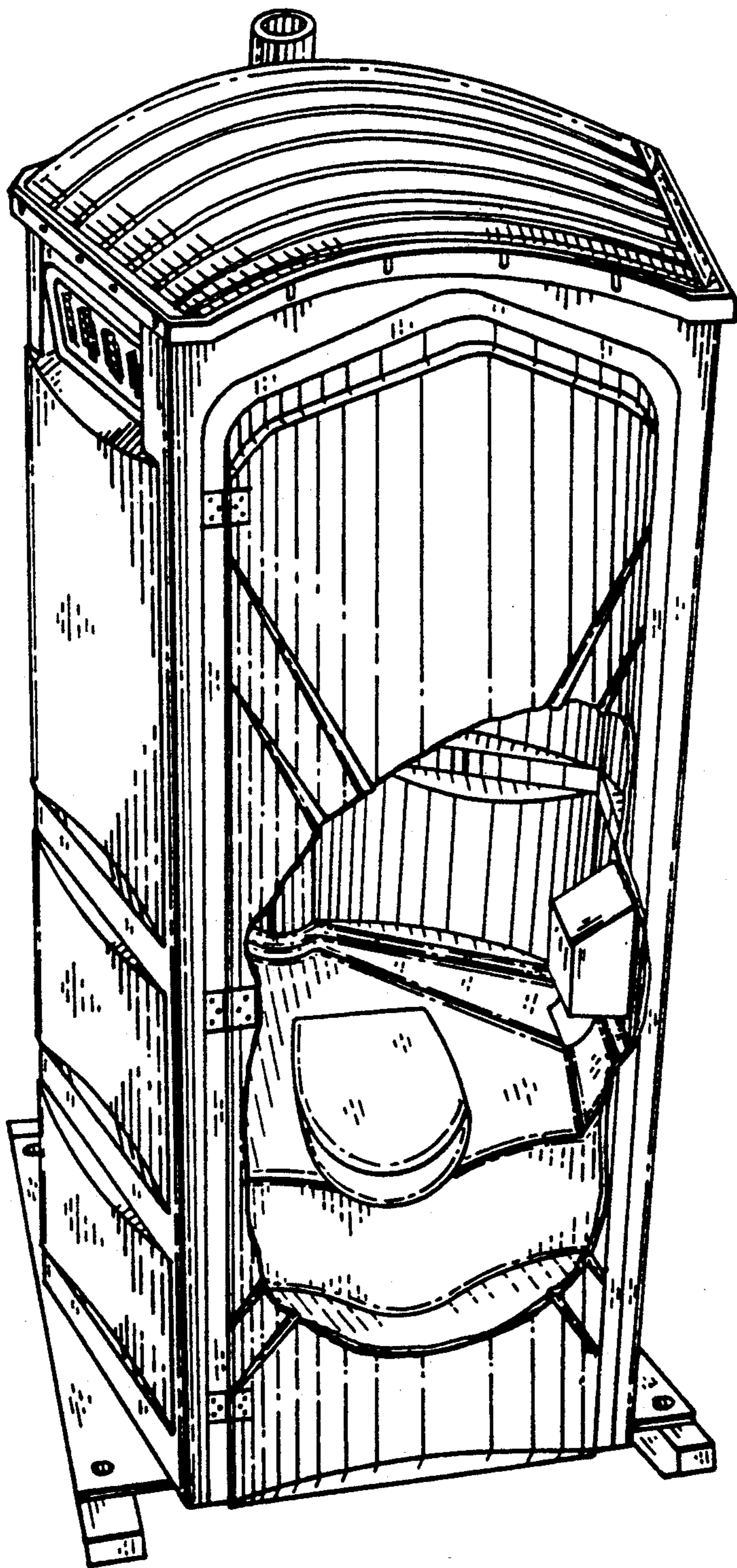

FIG. 19

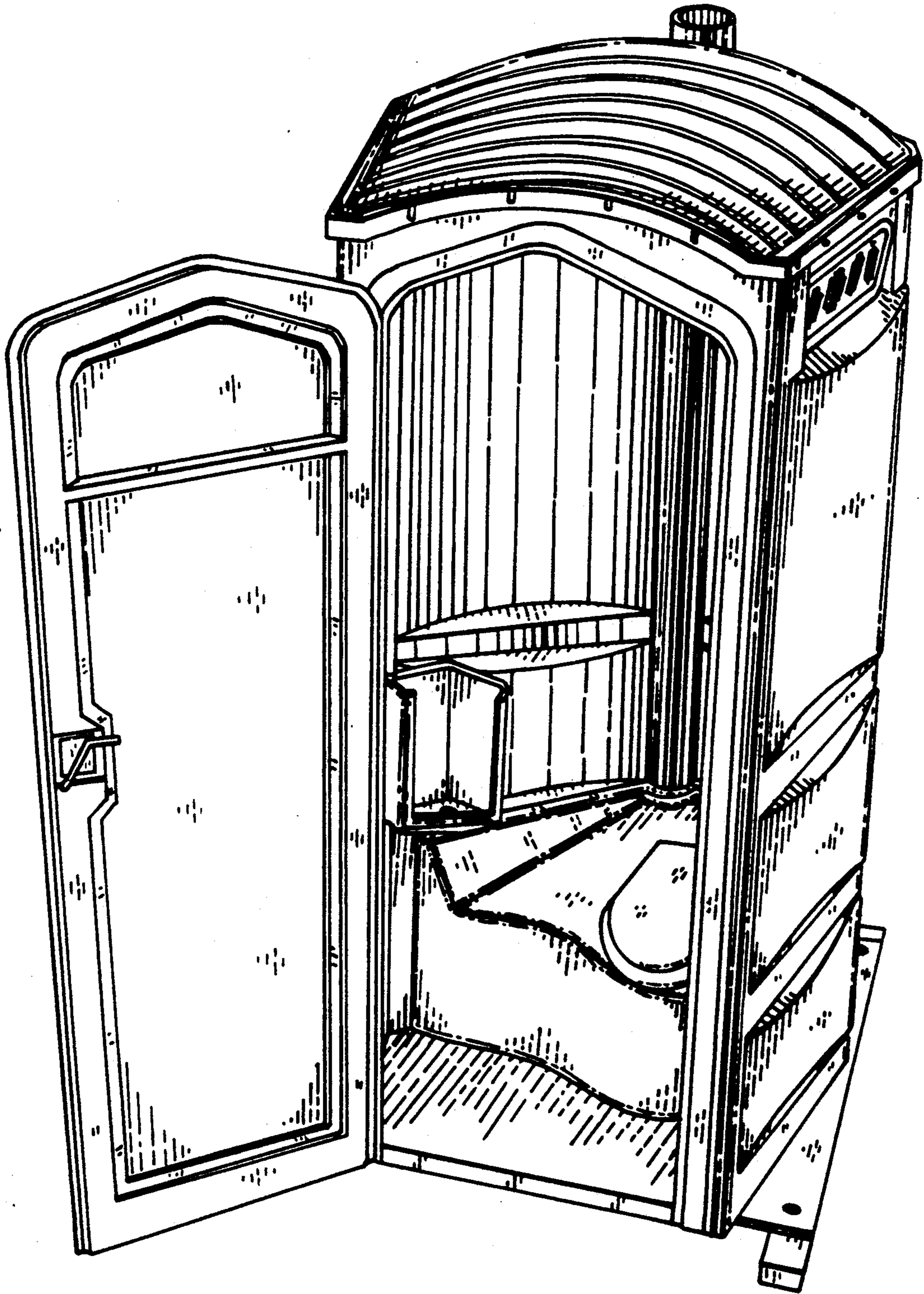

FIG. 20

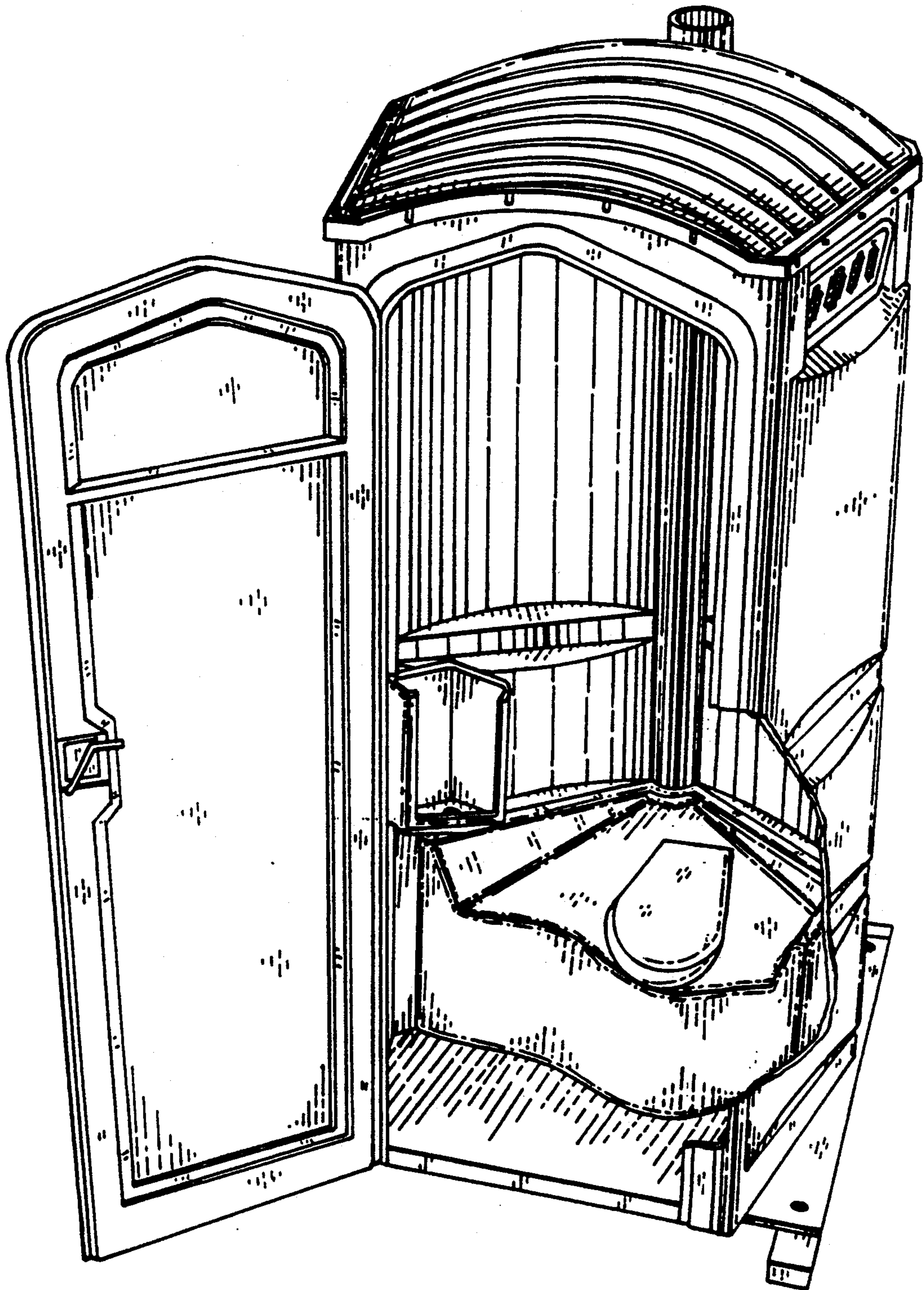

FIG. 21

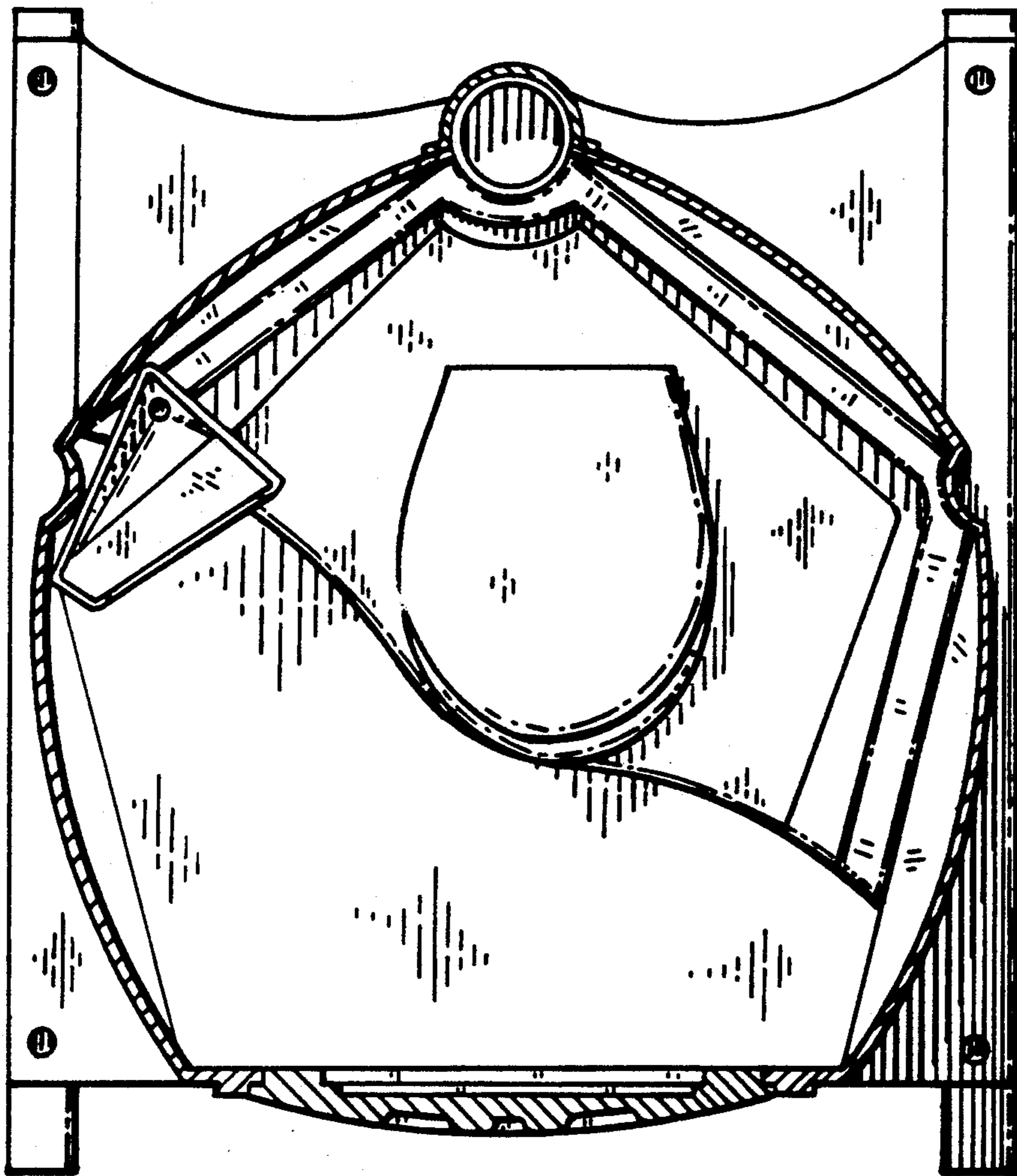

FIG. 22