



US00D337727S

United States Patent [19]

[11] Patent Number: Des. 337,727

Benton

[45] Date of Patent: ** Jul. 27, 1993

[54] **BOOK CLOCK**

[75] Inventor: Michael Benton, Broken Arrow, Okla.

[73] Assignee: Selco Industries Corporation, Tulsa, Okla.

[**] Term: 14 Years

[21] Appl. No.: 773,306

[22] Filed: Oct. 9, 1991

[52] U.S. Cl. D10/6; D10/18

[58] Field of Search D10/1-40,
D10/122-132; 368/10, 276-277, 280-282,
316-317

[56] **References Cited**

U.S. PATENT DOCUMENTS

| | | | | |
|------------|---------|----------|-------|---------|
| D. 15,559 | 11/1884 | Jerome | | D10/6 |
| D. 109,323 | 4/1938 | Jenkins | | D10/6 |
| D. 238,856 | 2/1976 | Koplar | | D10/6 |
| D. 255,433 | 6/1980 | Anderson | | D10/15 |
| D. 313,188 | 12/1990 | Tsui | | D10/2 X |
| 2,125,294 | 8/1938 | Lathrop | | D10/26 |

Primary Examiner—Nelson C. Holtje
Attorney, Agent, or Firm—Sixbey, Friedman, Leedom & Ferguson

[57] **CLAIM**

The ornamental design for a clock, as shown and described.

DESCRIPTION

FIG. 1 is a perspective view of the clock of the present invention in its closed position;
FIG. 2 is a rear elevational view of the clock of FIG. 1;
FIG. 3 is a right, side elevational view of the clock of FIG. 1;
FIG. 4 is a left, side elevational view of the clock of FIG. 1;
FIG. 5 is a top plan view of the clock of FIG. 1;
FIG. 6 is a bottom plan view of the clock of FIG. 1; and,
FIG. 7 is a perspective view of the clock of FIG. 1 in its open position.
The broken-line portions of the clock face of FIG. 7 are environmental only and form no part of the claimed design.

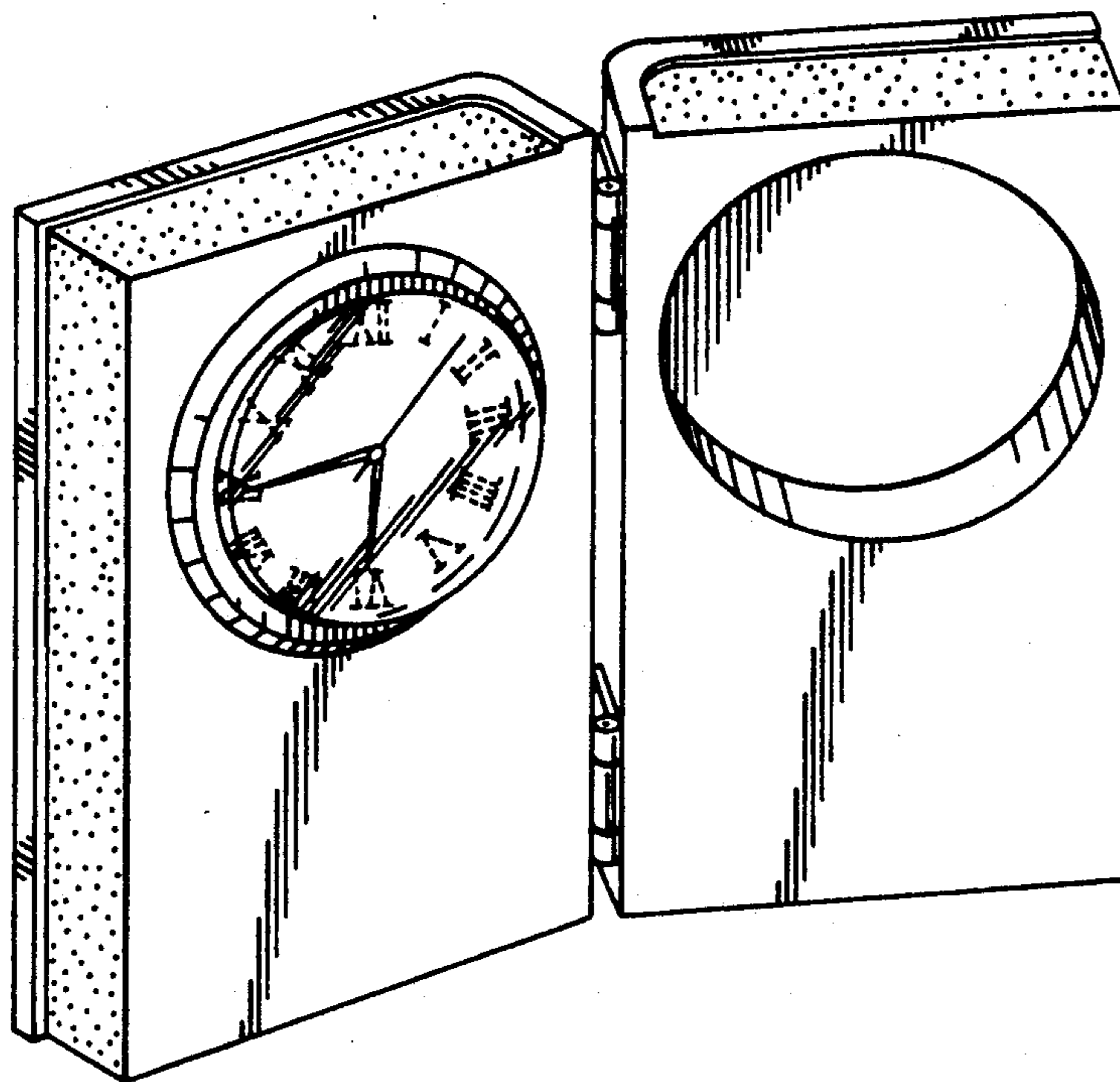

FIG. 1

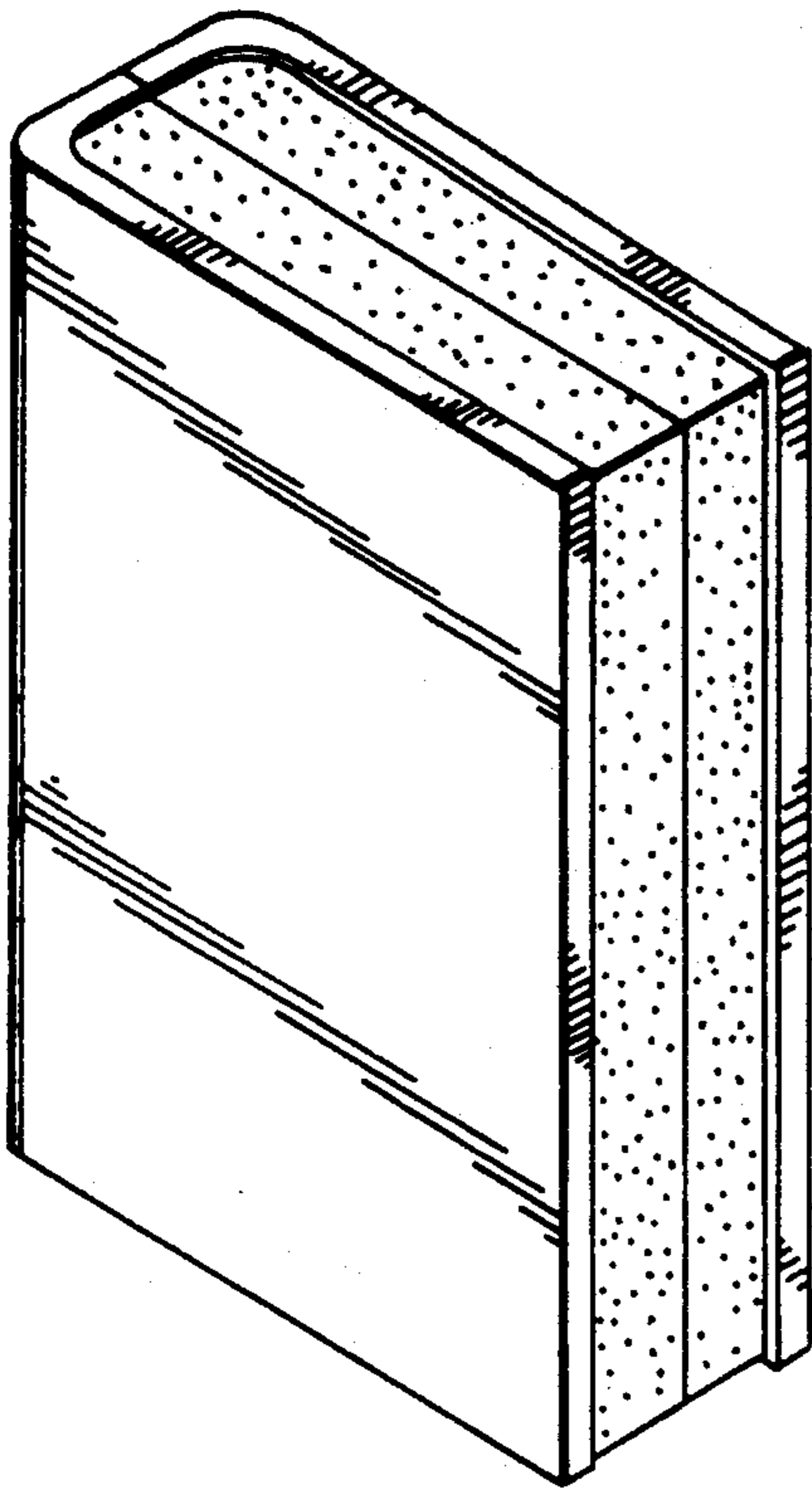

FIG. 2

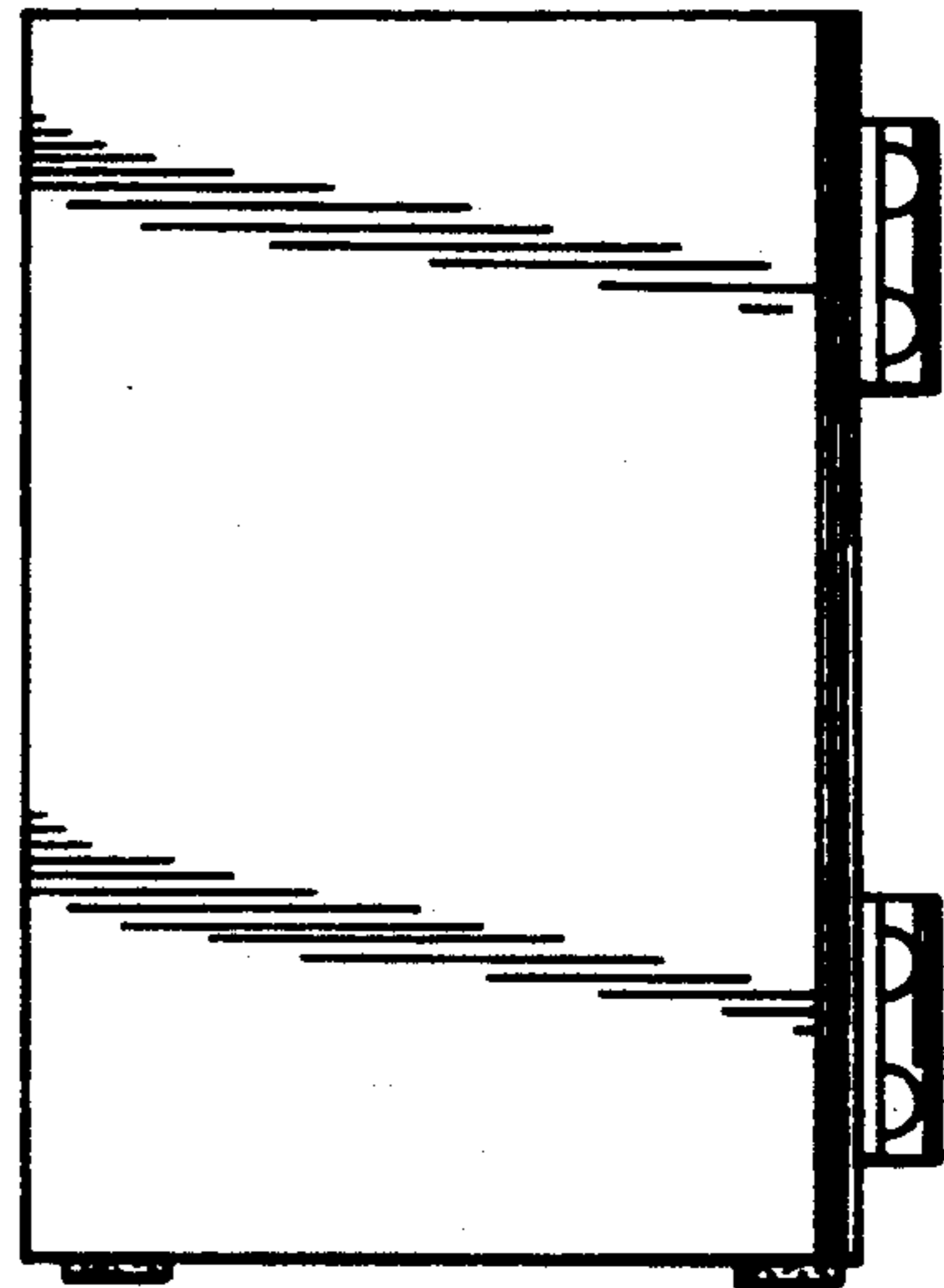

FIG. 3

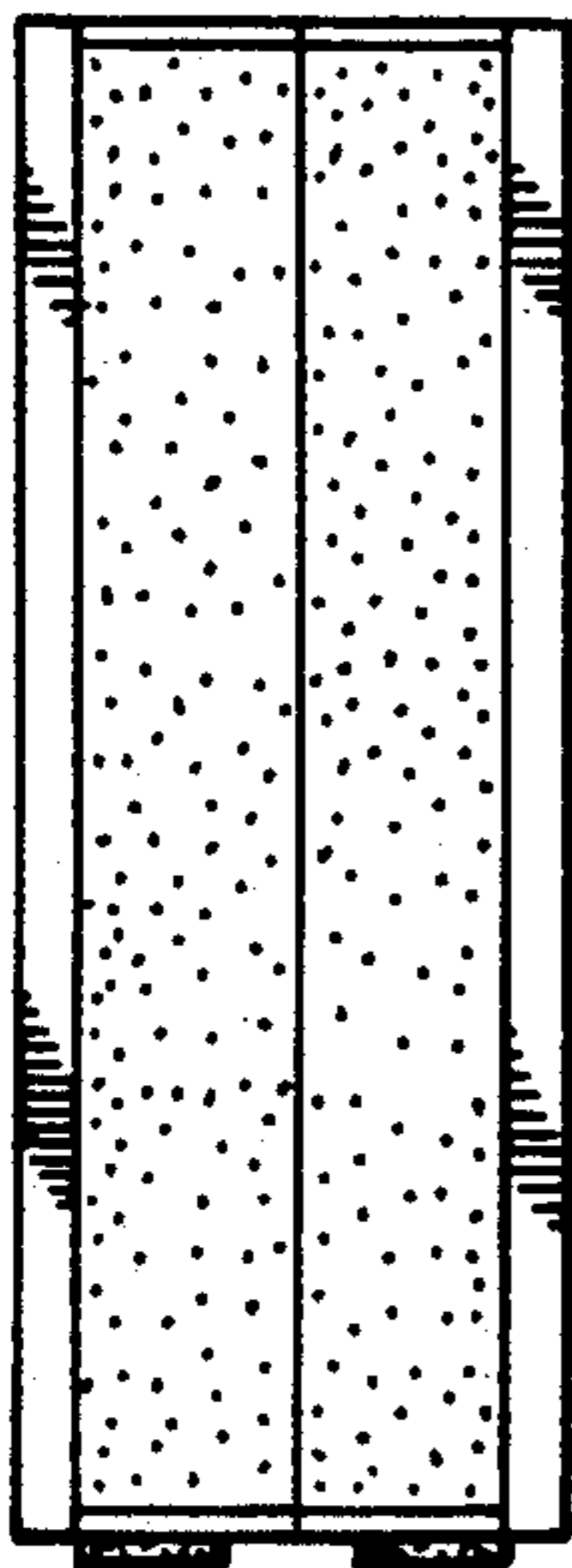

FIG. 4

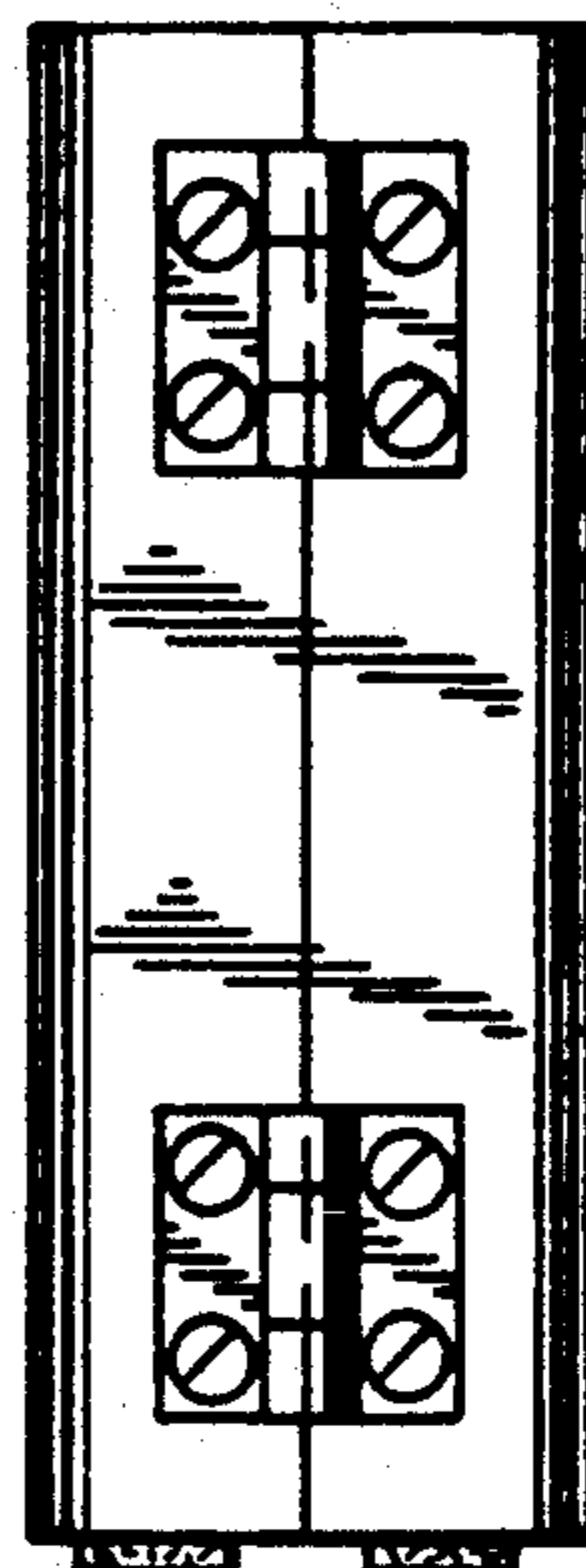

FIG. 5

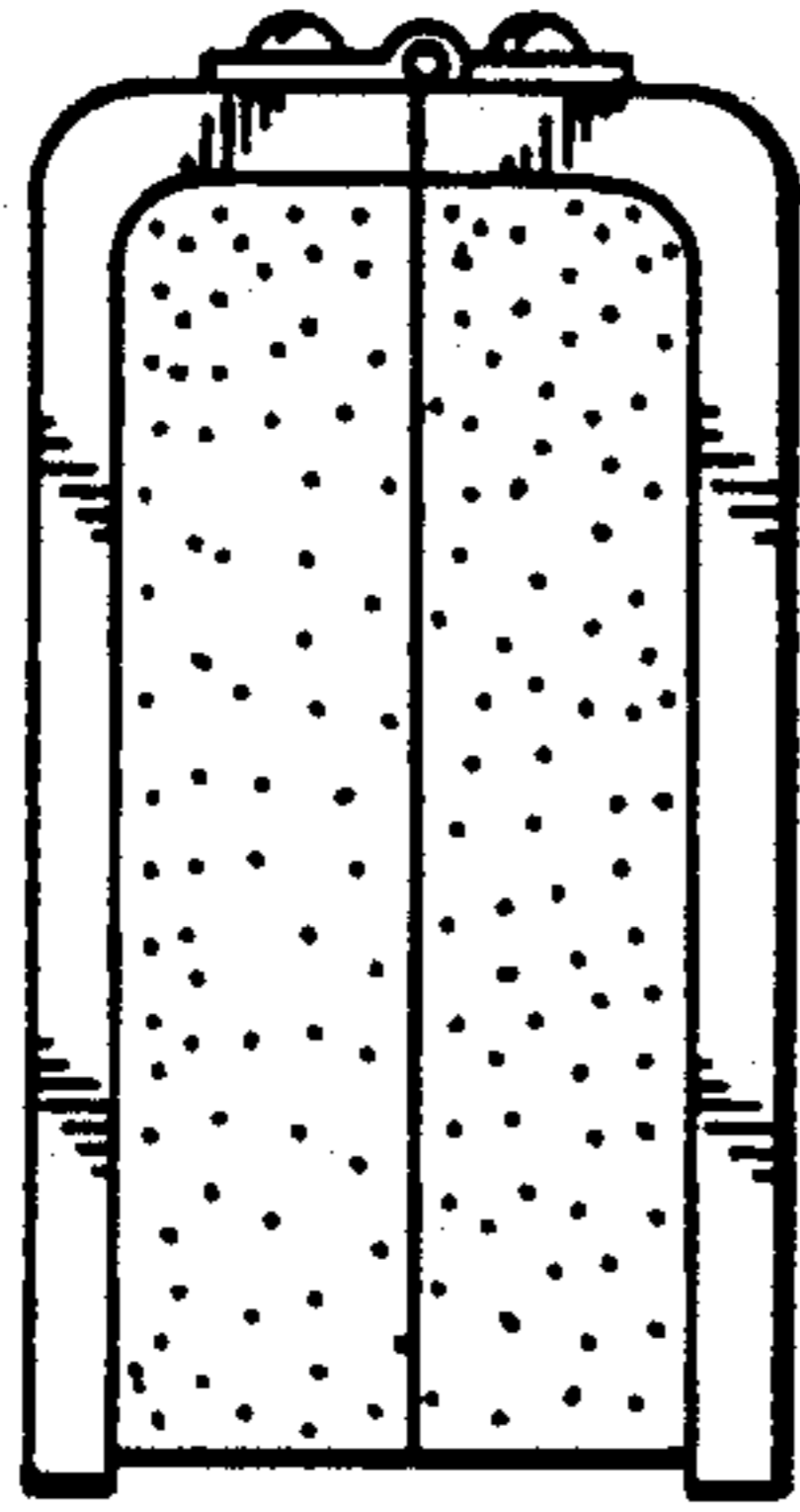

FIG. 6

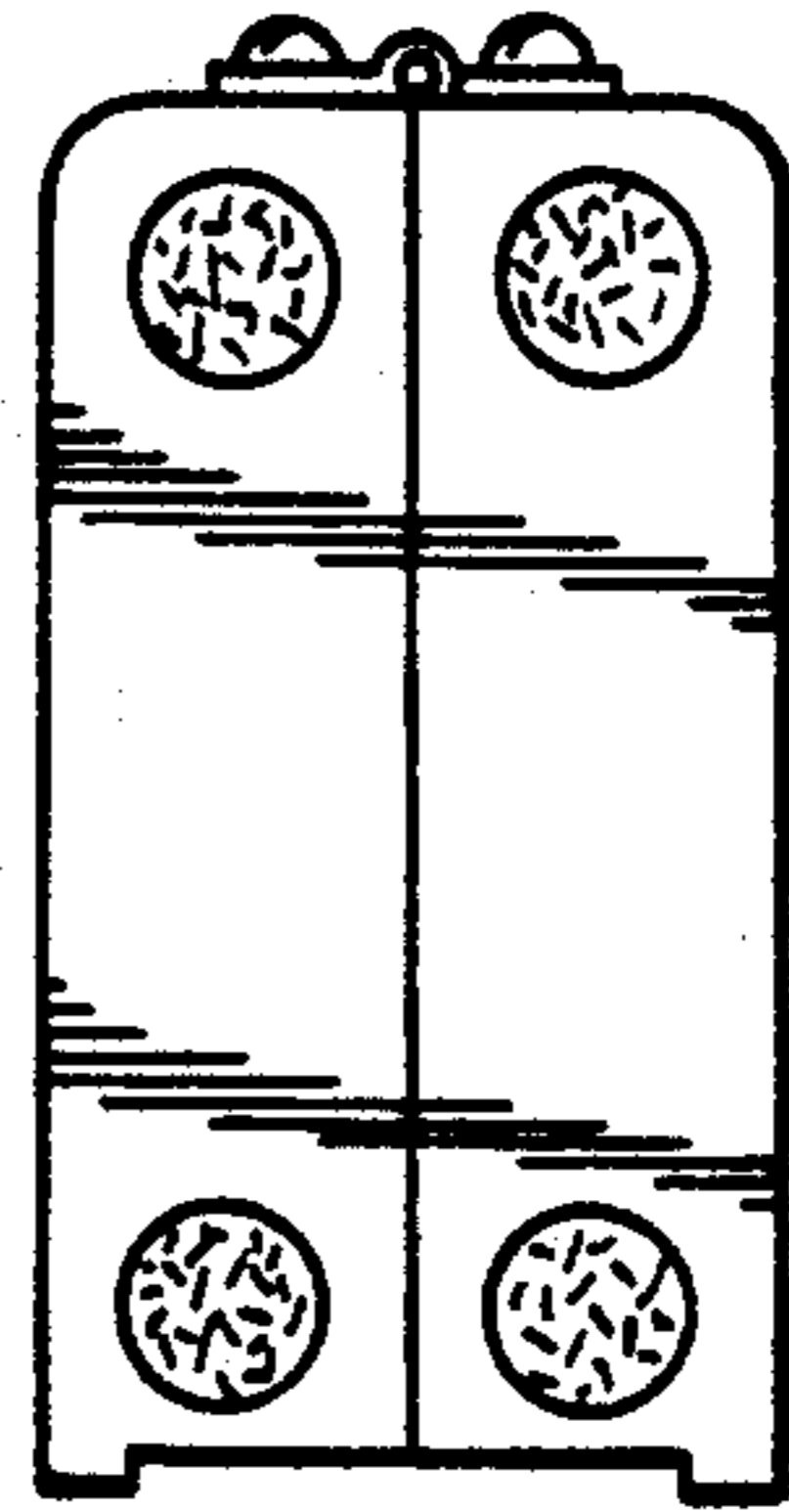

FIG. 7

