



US00D337725S

# United States Patent [19]

[11] Patent Number: Des. 337,725

Bunin

[45] Date of Patent: \*\* Jul. 27, 1993

- [54] **PILL CONTAINER**
- [75] Inventor: **Leo Bunin**, Woodbridge, N.J.
- [73] Assignee: **Merck & Co., Inc.**, Rahway, N.J.
- [\*\*] Term: **14 Years**
- [21] Appl. No.: **706,460**
- [22] Filed: **May 28, 1991**
- [52] U.S. Cl. .... **D9/341; D3/301; D3/74; D9/416**
- [58] Field of Search ..... **D3/30.1, 74; D9/339, D9/341, 347, 416; 206/531, 532, 828**

5,163,559 11/1992 Bunin ..... 206/532

### FOREIGN PATENT DOCUMENTS

- 66949 9/1990 Canada .
- 397382 11/1989 France .
- 1953600 4/1990 Netherlands .
- 2018225 10/1979 United Kingdom ..... 206/538
- 2169263 7/1986 United Kingdom ..... 206/828
- 2002624 7/1989 United Kingdom .

### [56] References Cited

#### U.S. PATENT DOCUMENTS

- D. 227,552 7/1973 Bridges ..... D9/339
- 235,080 5/1971 Verona et al. .
- 255,218 12/1977 Krag .
- D. 271,081 10/1983 Noble ..... D9/341
- D. 298,803 12/1988 Ebling ..... D9/339
- 304,905 2/1987 Zimmerman .
- 3,703,955 11/1972 Inacker .
- 3,738,480 6/1973 Chesley .
- 4,047,615 9/1977 Browne .
- 4,248,349 2/1981 Locke et al. .
- 4,372,445 2/1983 Keffeler .
- 4,673,086 6/1987 Braverman et al. .
- 4,735,318 4/1988 Keffeler ..... 206/532
- 4,793,492 12/1988 Halbich .
- 4,911,291 3/1990 Iwata et al. .

*Primary Examiner*—A. Hugo Word  
*Assistant Examiner*—Celia A. Murphy  
*Attorney, Agent, or Firm*—Charles M. Caruso

### [57] CLAIM

The ornamental design for a pill container, as shown and described.

### DESCRIPTION

FIG. 1 is a perspective view of a pill container and the like showing my new design;  
 FIG. 2 is a right side elevation thereof, the left side elevation being a mirror image thereof;  
 FIG. 3 is a sectional view taken on line 3—3 of FIG. 2;  
 FIG. 4 is a top plan view thereof;  
 FIG. 5 is a front elevation thereof;  
 FIG. 6 is a bottom plan view thereof;  
 FIG. 7 is a rear elevation thereof; and,  
 FIG. 8 is an exploded perspective thereof, the broken lines showing a pill being for illustrative purposes only and forming no part of the claimed design.

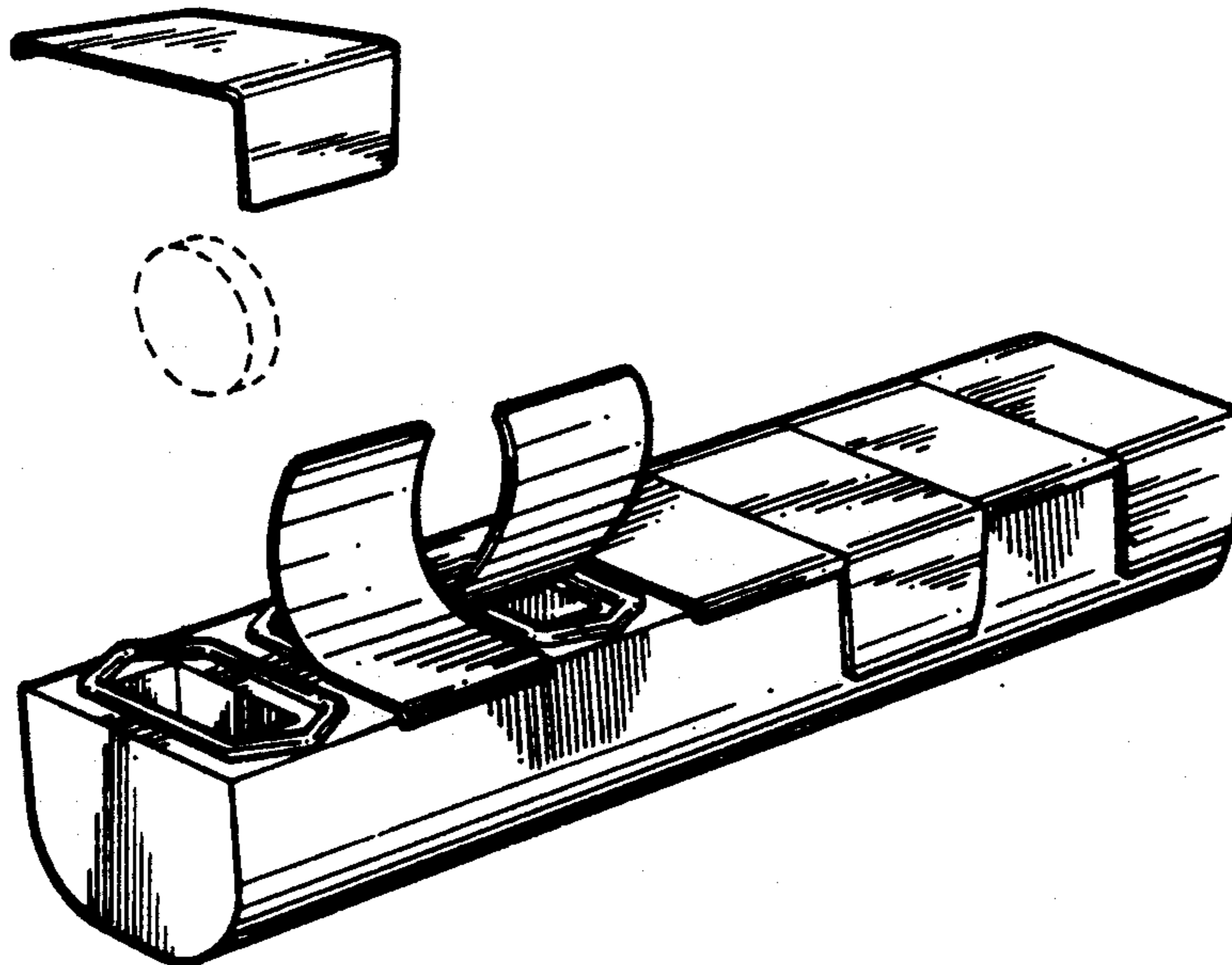

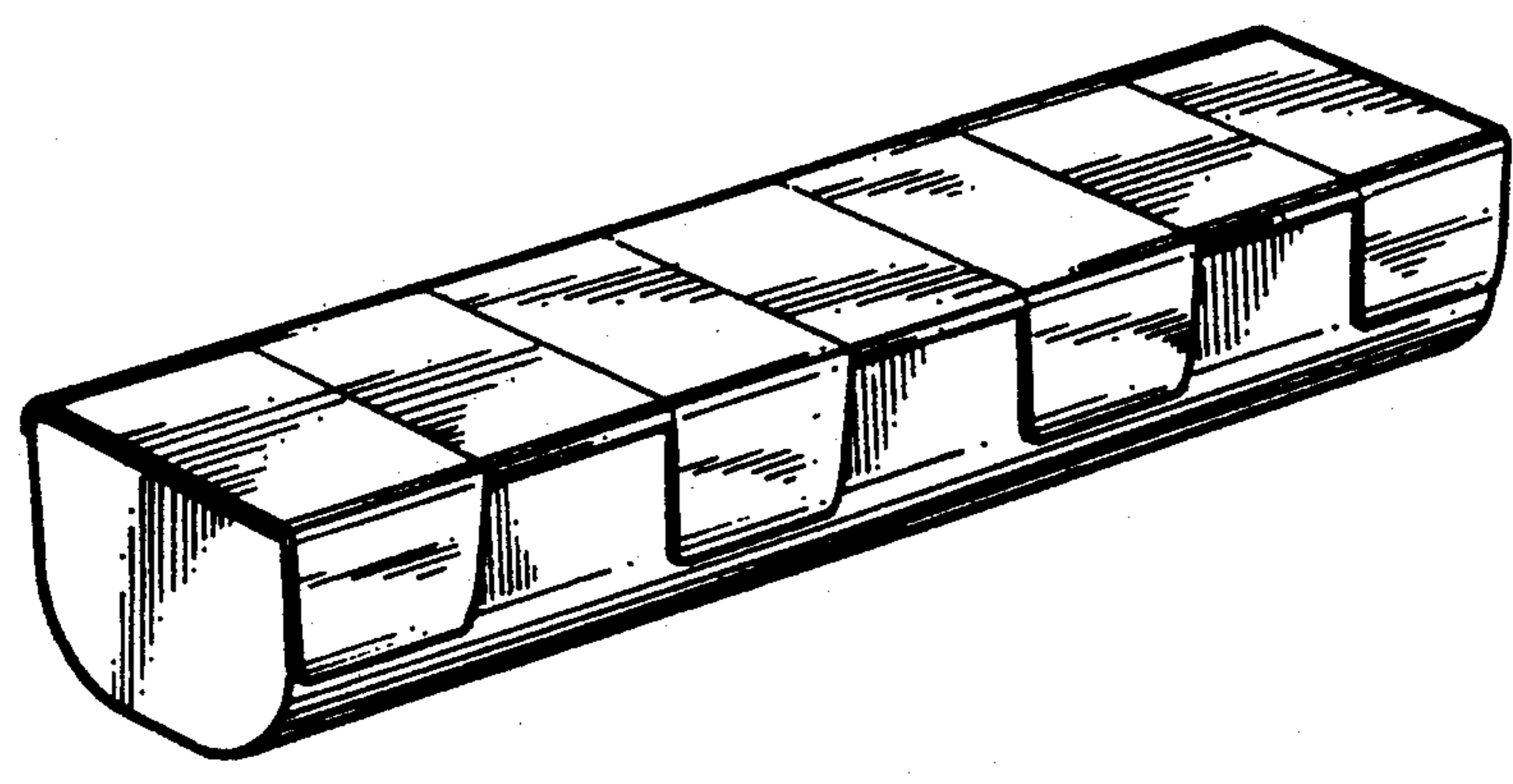

FIG. 1

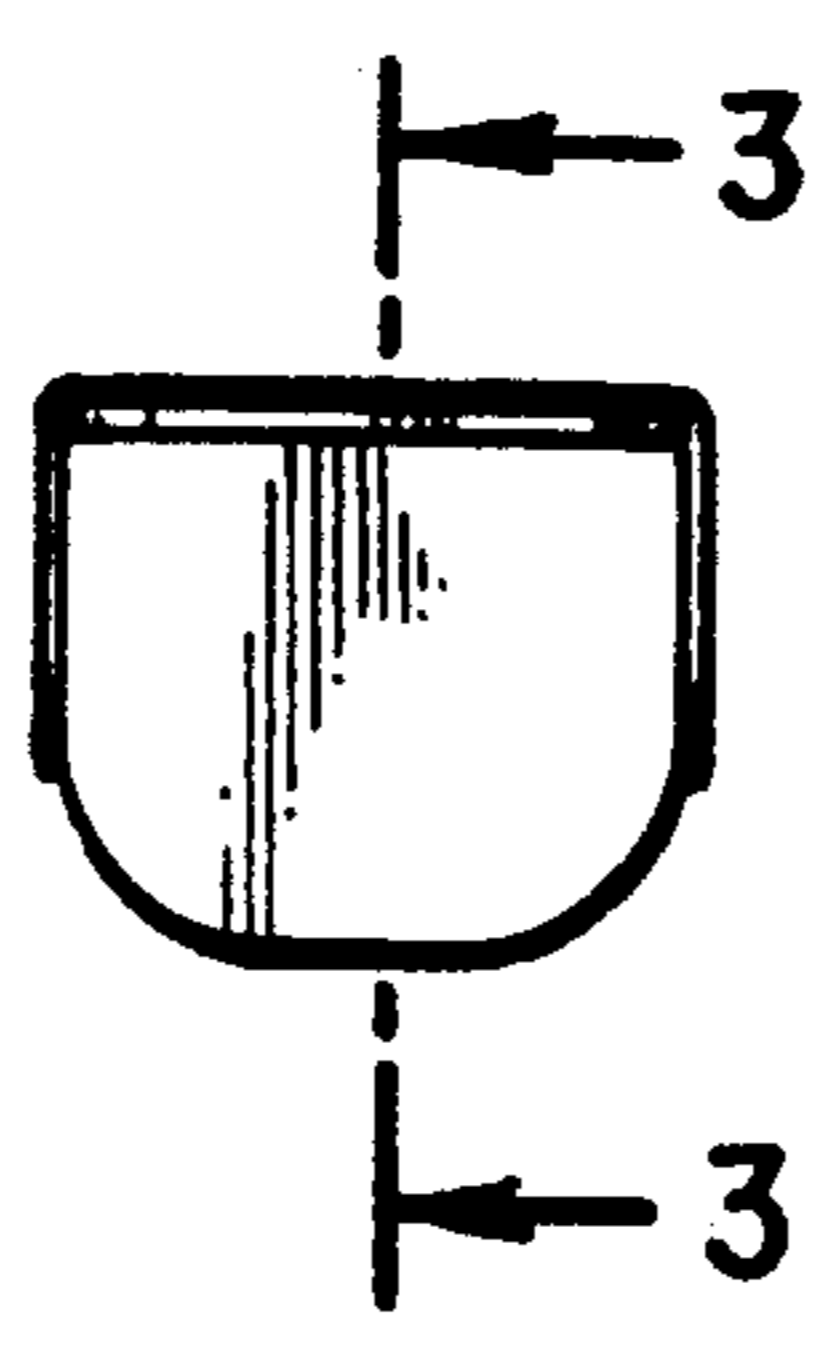

FIG. 2

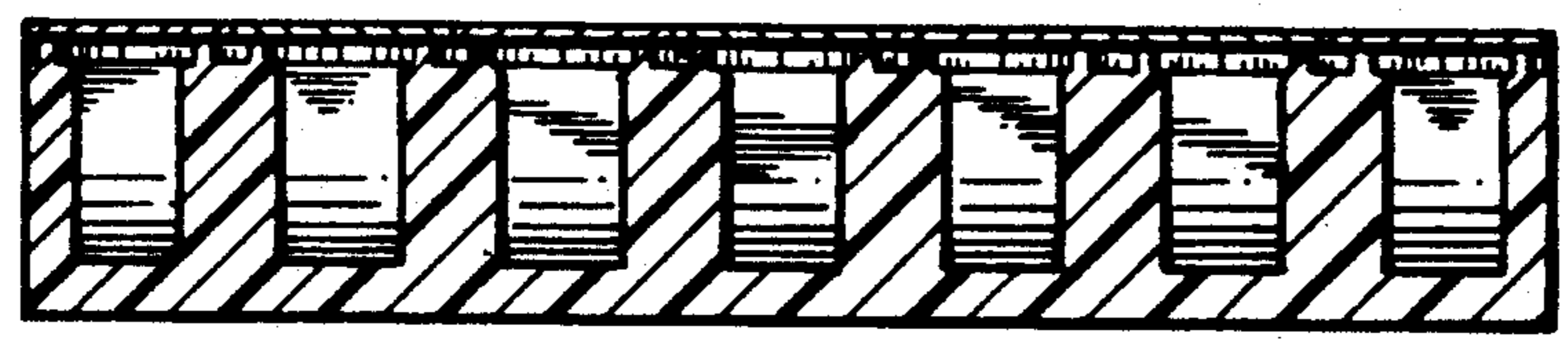

FIG. 3

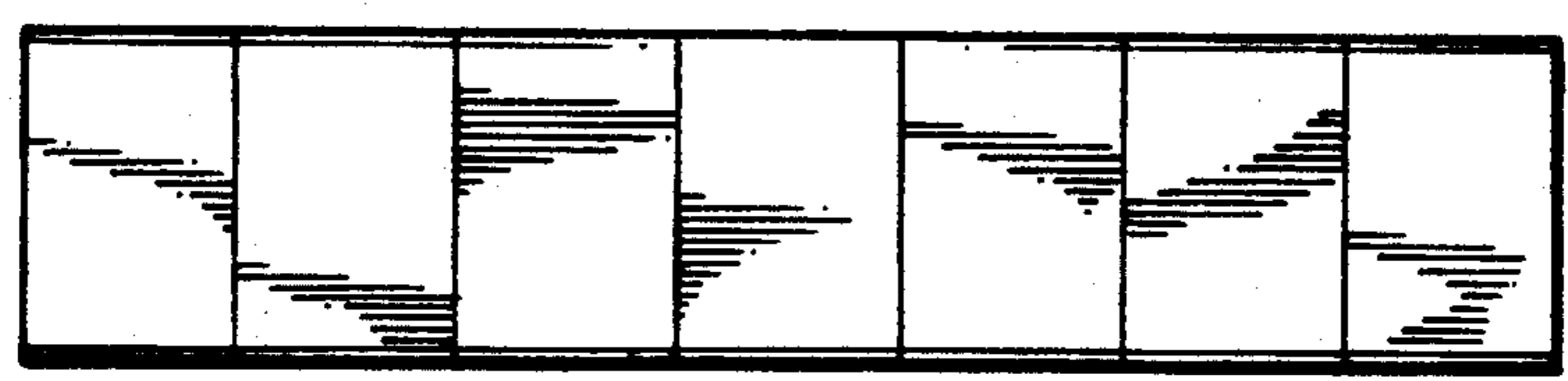

FIG. 4

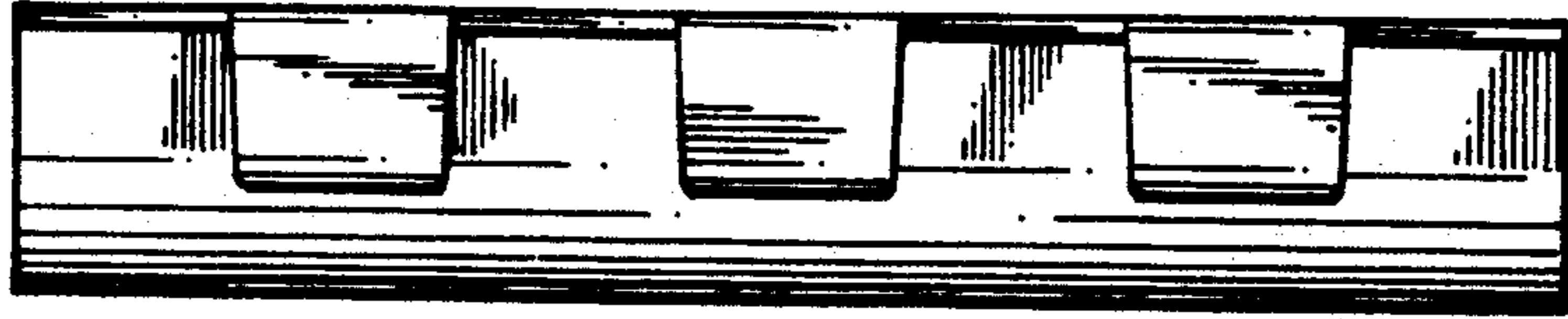

FIG. 5

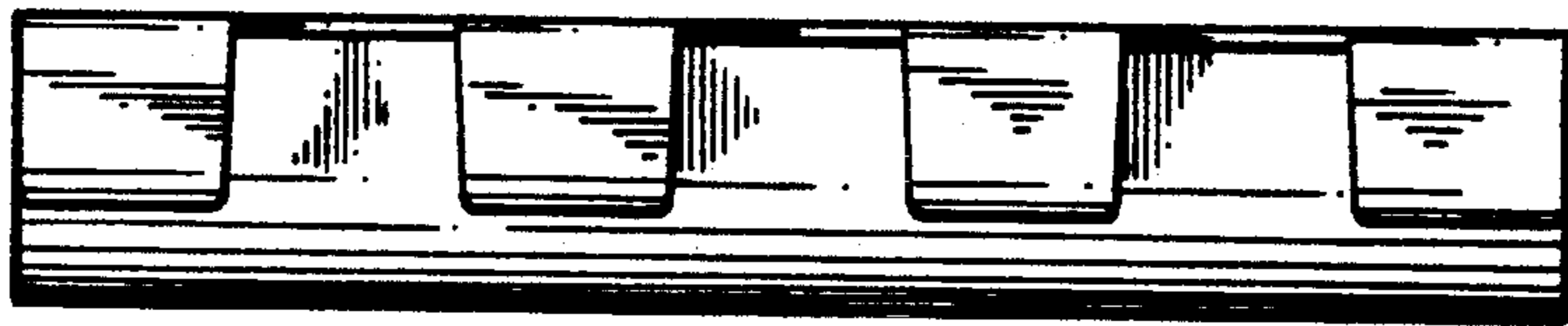

FIG. 7

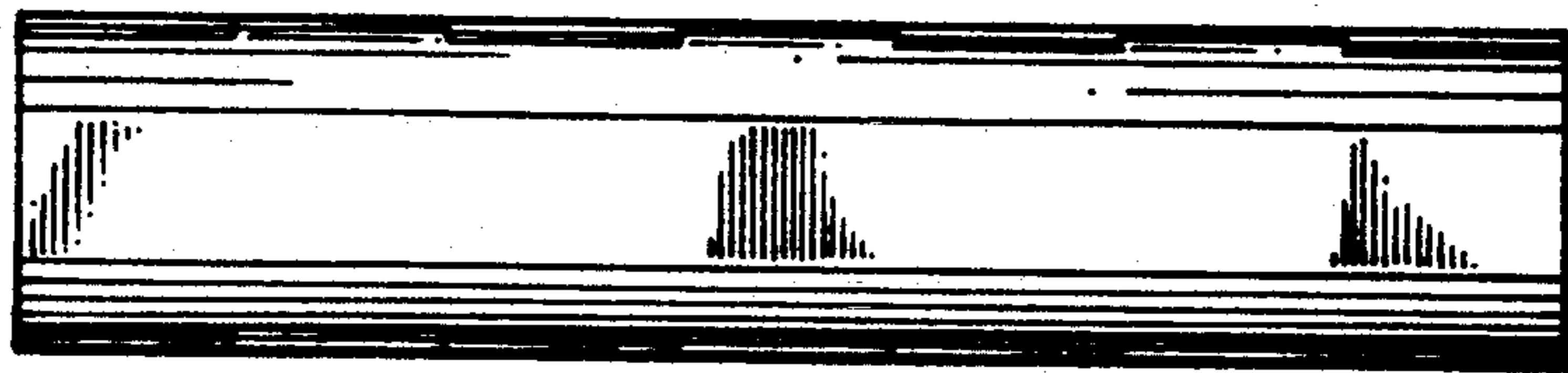

FIG. 6

FIG. 8

