



US00D337574S

United States Patent [19]

[11] Patent Number: **Des. 337,574**

Iino

[45] Date of Patent: **** Jul. 20, 1993**

[54] **ELECTRONIC COMPUTER**

[75] Inventor: **Masaaki Iino, Yokohama, Japan**

[73] Assignee: **Kabushiki Kaisha Toshiba, Kanagawa, Japan**

[**] Term: **14 Years**

[21] Appl. No.: **528,186**

[22] Filed: **May 24, 1990**

[30] **Foreign Application Priority Data**

Nov. 29, 1989 [JP] Japan 1-43098
Nov. 29, 1989 [JP] Japan 1-43099

[52] U.S. Cl. **D14/106**

[58] Field of Search D14/100, 101, 106, 113, D14/115; D18/1, 7; 235/145 A, 145 R; 340/700, 706, 707, 712; 341/22, 23; 364/708, 709; 361/390, 380

[56] **References Cited**

U.S. PATENT DOCUMENTS

- D. 224,784 7/1972 Sucre et al. D26/5
- D. 243,250 2/1977 Hazama D26/5 C
- D. 254,005 1/1980 Zadock et al. D14/43
- D. 269,529 6/1983 Luen D19/22
- D. 275,102 8/1984 MacConnel D14/106
- D. 280,511 9/1985 Moggridge et al. D14/106
- D. 280,622 9/1985 Moggridge et al. D14/100
- D. 282,843 3/1986 Kurihara et al. D14/100
- D. 283,511 4/1986 Dunn D14/106
- D. 284,193 6/1986 Marshall D14/101
- D. 284,474 7/1986 Sawada D14/100
- D. 284,966 8/1986 Larkins D14/100
- D. 287,969 1/1987 Kusanagi D14/106
- D. 288,566 3/1987 Chin et al. D14/106
- D. 289,177 4/1987 Sawada D18/7
- D. 289,763 5/1987 Fujii et al. D14/106
- D. 290,256 6/1987 Sapper et al. D14/106
- D. 290,609 6/1987 Harlan et al. D14/100
- D. 290,845 7/1987 Yubisui et al. D14/111
- D. 291,442 8/1987 Kurihara D14/106
- D. 293,677 1/1988 Hara et al. D14/106
- D. 293,678 1/1988 Sawatani et al. D14/106
- D. 294,029 2/1988 Nishiyama et al. D14/106
- D. 294,831 3/1988 Hara et al. D14/106
- D. 295,176 4/1988 Nishimoto et al. D14/106
- D. 295,519 3/1988 Kimble D14/106

- D. 298,623 11/1988 Yubisui et al. D14/100
- D. 299,031 12/1988 Sugano D14/106
- D. 303,250 9/1989 Ver Nooy et al. D14/106
- D. 303,523 9/1989 Shiozawa et al. D14/106
- D. 303,790 10/1989 Kato et al. D14/106
- D. 304,930 12/1989 Hongo et al. D14/100
- D. 305,883 2/1990 Burton D14/106
- D. 306,285 2/1990 Yu D14/106
- D. 307,581 5/1990 Ooshima D14/106
- D. 308,050 5/1990 Sugano et al. D14/106
- D. 308,051 5/1990 Sakai D14/106
- D. 308,516 6/1990 Takach, Jr. et al. D14/106
- D. 308,860 6/1990 Tsukada et al. D14/106
- D. 308,861 6/1990 Tsukada et al. D14/106
- D. 309,603 7/1990 Mizusugi et al. D14/106
- D. 309,749 8/1990 Ido D18/7
- D. 310,353 9/1990 Sugano et al. D14/106
- D. 310,828 9/1990 Grundstrom et al. D14/106
- D. 311,527 10/1990 Fujii et al. D14/106
- D. 311,528 10/1990 Sugano et al. D14/106
- D. 311,741 10/1990 Sakai D14/106
- D. 311,906 11/1990 Iino D14/106
- D. 312,822 12/1990 Watabe et al. D14/106
- D. 313,978 1/1991 Miyakuni D14/106
- D. 314,558 2/1991 Iino D14/106
- D. 316,706 5/1991 Imamura et al. D14/106
- D. 316,852 5/1991 Sai et al. D14/106
- D. 317,442 6/1991 Gintz et al. D14/106
- D. 317,444 6/1991 Mizusugi et al. D14/106
- D. 319,819 9/1991 Kawaguchi D14/106
- D. 322,246 12/1991 Izaki D14/100
- D. 323,156 1/1992 Nishida D14/101
- D. 324,035 2/1992 Izaki D14/100
- D. 324,036 2/1992 Wakasa D14/101
- D. 324,038 2/1992 Izaki D14/106
- D. 326,650 6/1992 Iino D14/106
- 4,703,160 10/1987 Narishima et al. 235/1 D
- 5,122,927 6/1992 Satou 361/380 X

FOREIGN PATENT DOCUMENTS

- 100708 6/1988 China .
- 100709 6/1988 China .
- 101093 7/1988 China .
- M8800660 10/1988 Fed. Rep. of Germany .
- M8803410 12/1989 Fed. Rep. of Germany .
- M8803411 12/1989 Fed. Rep. of Germany .
- M8908516 7/1990 Fed. Rep. of Germany .
- 47-14961 5/1972 Japan .
- 499866 4/1979 Japan .
- 639216 11/1984 Japan .

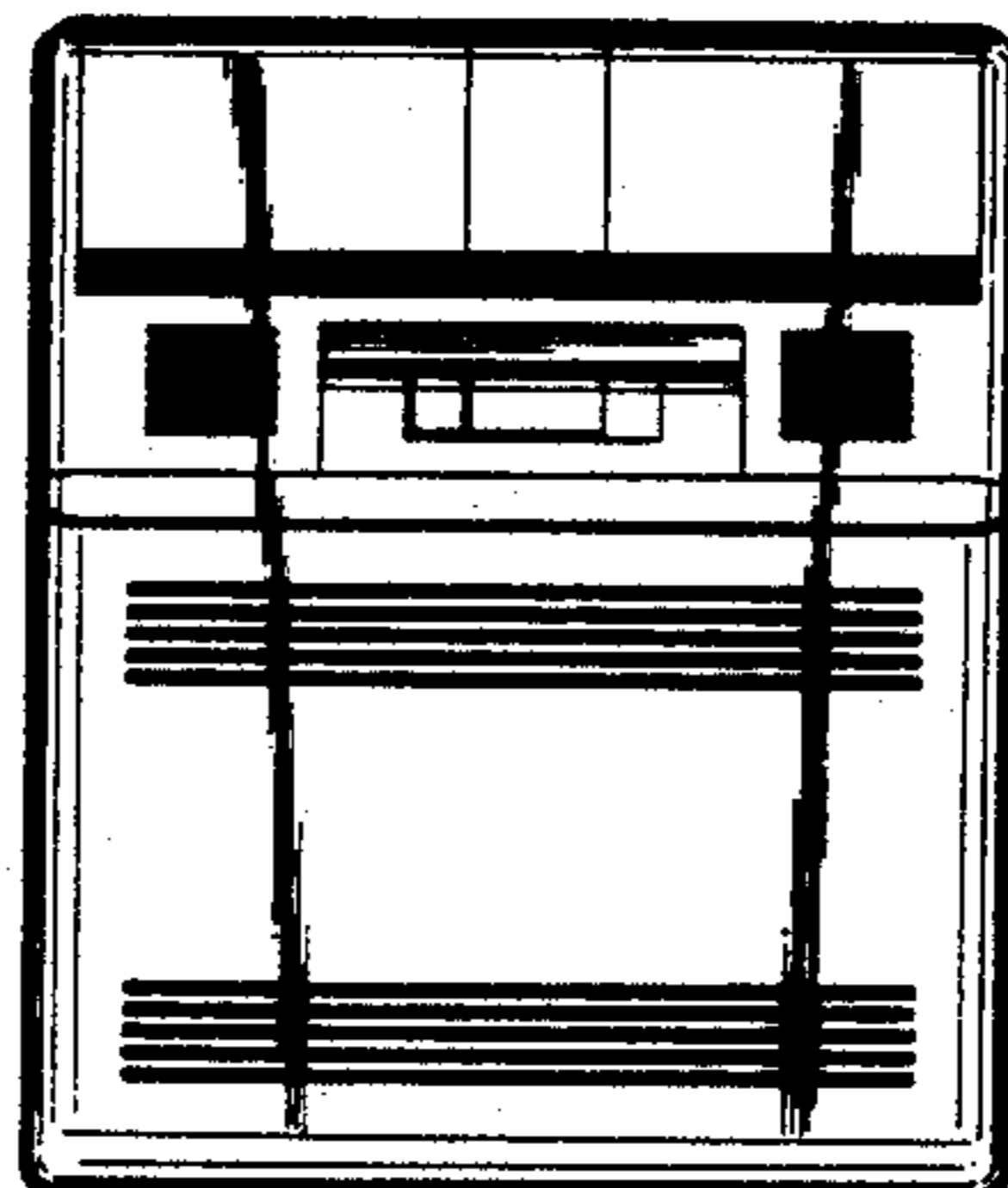
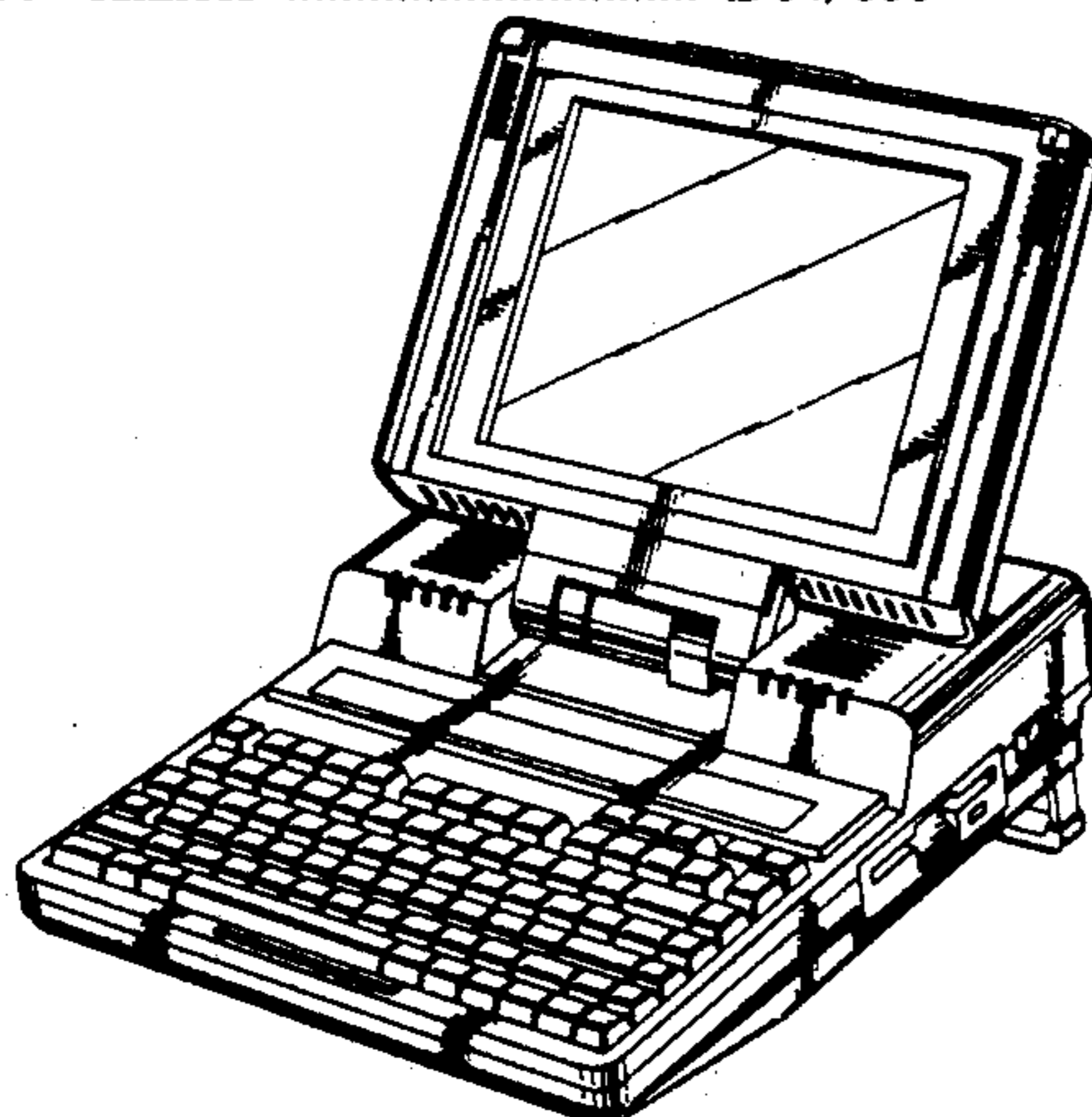

650470	5/1985	Japan .	Hewlett Packard Advertisement, May 18, 1984.
664175	10/1985	Japan .	Hewlett Packard Advertisement, Jun. 5, 1984.
684172	8/1986	Japan .	Epson HC-88, Jul. 1, 1984.
685000	8/1986	Japan .	Hitachi Advertisement, Sep. 4, 1984.
685063	8/1986	Japan .	Hewlett Packard Advertisement, Sep. 12, 1984.
685121	8/1986	Japan .	Sharp PC-5000 Brochure, Sep. 26, 1984.
685542	8/1986	Japan .	Data General One Advertisement, Sep. 28, 1984.
686374	9/1986	Japan .	Apple Computer Apple IIC, Oct. 15, 1984.
686381	9/1986	Japan .	TI Software Journal, Pro-Lite TM, Nov. 14, 1984.
686386	9/1986	Japan .	IS-11c Advertisement, Nov. 14, 1984.
686654	9/1986	Japan .	Dulmont Magnum Article in Portable Computer, Nov. 1984.
686658	9/1986	Japan .	IBM Advertisement, Dec. 6, 1984.
686706	9/1986	Japan .	Tandy 200, 1985.
685000	12/1986	Japan .	General Corp. 4400, Jan. 14, 1985.
695931	12/1986	Japan .	AVAL TM Advertisement, Feb. 11, 1985.
696188	1/1987	Japan .	Picture #J60007802, Feb. 26, 1985.
697328	1/1987	Japan .	AVAL TM20, Mar. 8, 1985.
763838	6/1988	Japan .	Tandy 200, Mar. 16, 1985.
747990	11/1988	Japan .	NEC Starlet PC-8401A Brochure, Mar. 28, 1985.
747991	11/1988	Japan .	C & D News, Mar. 29, 1985.
748513	11/1988	Japan .	Hewlett-Packard HP110, Apr. 1985.
749802	11/1988	Japan .	Fujitsu FM 16, Apr. 17, 1985.
746985(1)	4/1989	Japan .	Fujitsu FM16 TL Brochure, May 22, 1985.
746985(2)	4/1989	Japan .	Data General One Brochure, May 23, 1985.
761927	5/1989	Japan .	Toshiba T 1100 Plus, Jul. 22, 1985.
763840	6/1989	Japan .	Minato Electronics MODS-5000, Aug. 22, 1985.
763855	6/1989	Japan .	GridCase Brochure, Sep. 24, 1985.
761927(1)	2/1990	Japan .	FBS Advertisement, Oct. 30, 1985.
761927(3)	5/1990	Japan .	NEC N6919 Model 80/80H, Nov. 11, 1985.
761927(2)	5/1990	Japan .	IBM Advertisement, Nov. 28, 1985.
761927(4)	6/1990	Japan .	Apple Computer IIC, Dec. 1985.
67297	2/1987	Rep. of Korea .	Hewlett-Packard Portable Plus, Dec. 1985.
85031	10/1988	Rep. of Korea .	FLM-700, Jan. 31, 1986.
85032	10/1988	Rep. of Korea .	Fujitsu FM 16, May 21, 1986.
92859	7/1989	Rep. of Korea .	PC-816F Advertisement, May 27, 1986.
92863	7/1989	Rep. of Korea .	Zenith Data Systems NEWSDATE Newsletter, Jun.-Jul. 1986.
94470	9/1989	Rep. of Korea .	Tandy 600 Advertisement, Jul. 25, 1986.
97355	12/1989	Rep. of Korea .	Ricoh JP70D Brochure, Sep. 29, 1986.
100917	4/1990	Rep. of Korea .	Data General One Brochure, Oct. 3, 1986.
			Article re IBM Portable Personal Computer, Oct. 15, 1986.
			NEC PC-98LT Advertisement, Oct. 23, 1986.
			Yaskawa P-t50 Advertisement, Nov. 12, 1986.

OTHER PUBLICATIONS

Sharp Advertisement, May 19, 1976.
 Fanuc System P-Model, Jul. 27, 1983.
 Moebel Interior Design, Jan. 5, 1984.
 The Office 98-6, Jan. 31, 1984.
 Demus 645, Feb. 22, 1984.
 MRD Advertisement, Mar. 29, 1984.
 Gavilan Mobile Computer Brochure, Apr. 19, 1984.
 Picture #J9016870, May 8, 1984.

Yaskawa Memocon ®-SC GL20 Advertisement, Mar. 27, 1987.
 TI Advertisement in Telephony, Apr. 1, 1987.
 Data General One Model 2J Brochure, May 20, 1987.
 Hitachi B16LX Brochure, Aug. 31, 1987.
 Ricoh Brochure, Sep. 17, 1987.
 Sony Produce 100 Brochure, Sep. 18, 1987.
 Panasonic FW-U1EX Advertisement, Oct. 2, 1987.
 Nihon IBM 55 Model 5535, Oct. 19, 1987.
 NEC Minitel 5 Advertisement, Oct. 29, 1987.
 Rein Laptop 300 SLC Advertisement, Oct. 29, 1987.
 IBM 5540/5535 Brochure, Nov. 4, 1987.
 NEC PC-9800 Advertisement, Nov. 27, 1987.
 Panasonic U1EX Advertisement, Dec. 8, 1987.
 Schneider Multivision 300 SLC Catalog, 1988.
 Panasonic U1Pro, Jan. 4, 1988.
 Diagnostic Products Review, Jan.-Feb. 1988.
 Toshiba E & E News, Feb. 26, 1988.
 Seiko-Epson PC-286L, Mar. 2, 1988.
 Toshiba JW90FII Rupo Brochure, Mar. 3, 1988.
 Hitachi B16LX Brochure, Apr. 5, 1988.
 Sony Produce PJ-100EX Brochure, Apr. 5, 1988.
 WS Japanese Advertisement, Apr. 27, 1988.
 NEC Multispeed, Spring '88.
 Samsung S5200, May 10, 1988.
 Datavue Snap 1+1, May 10, 1988.
 Portable Computer Review, p. 32, May 10, 1988.
 GridCase 1530 Advertisement, May 10, 1988.
 NEC MultiSpeed EL Model 2 Brochure, May 10, 1988.
 Sharp PC-5000 Brochure, May 12, 1988.
 Japanese Advertisement, May 12, 1988.
 Sanyo ES 100, May 13, 1988.
 NEC PC-9801 LV 21 Brochure, May 13, 1988.
 Sharp WV-500, May 19, 1988.
 Panafacom C-250 LT Brochure, May 19, 1988.
 Sony Produce 100EX Advertisement, May 19, 1988.
 Panasonic Panacom 6000 LT Brochure, Jun. 7, 1988.
 NEC Mini 5 Carryword Brochure, Jun. 27, 1988.
 Ricoh JP90LX Brochure, Jun. 28, 1988.
 NEC Mini 5 HL Brochure, Jun. 30, 1988.
 NEC PC-98 LT Brochure, Jul. 14, 1988.
 NEC PC-9801 LX5C, Aug. 23, 1988.
 Kyosera 386AX, Sep. 1988.
 Sharp AX 286L, Sep. 29, 1988.
 NEC PC-9801, Oct. 26, 1988.
 Sanyo MBC 17LTJH, Oct. 1988.

Toshiba T 1600, Nov. 1988.
 Sanyo MBC 17LTJH, Nov. 1988.
 Oki "IF 386 AX", Dec. 9, 1988.
 Kyosera 386-SX Laptop AX, Jan. 10, 1989.
 Seiko-Epson PC-286LS, Feb. 16, 1989.
 Chaplet Halikan LA-22, Apr. 21, 1989.
 NEC PC-9801 LV21, May 13, 1989.
 Fujitsu G-150LT, May 19, 1989.
 Epson HC-88, HC80 Brochure, undated.
 Epson PX-8 Personal Computer Brochure, undated.
 Mitsubishi mp286L Laptop Personal Computer Brochure, undated.
 Grid Brochure, undated.
 Dauphin Laptop Computer Brochure, undated.
 MicroDIRECT Brochure, undated.
 SuperSport Brochure, undated.
 Panasonic KX-D4930 Advertisement, undated.
 Ampere WS-1 Advertisement, undated.
 NEC Contrast, undated.
 NEC Starlet PC-8410A Advertisement, undated.
 Victor Technologies, V 286 P-Catalog, undated.
 Visual Computer Brochure, undated.
 Gavilan Mobile Computer Brochure, undated.
 Olivetti Personal Computer M15 Brochure, undated.
 Primary Examiner—Wallace R. Burke
 Assistant Examiner—Freda S. Nunn
 Attorney, Agent, or Firm—Banner, Birch, McKie & Beckett

[57]

CLAIM

The ornamental design for an electronic computer, as shown and described.

DESCRIPTION

FIG. 1 is a top front and right side perspective view of an electronic computer showing my new design in an operative position;
 FIG. 2 is a front elevational view thereof;
 FIG. 3 is a top plan view thereof;
 FIG. 4 is a left side elevational view thereof;
 FIG. 5 is a rear elevational view thereof;
 FIG. 6 is a bottom plan view thereof;
 FIG. 7 is a front elevational view thereof;
 FIG. 8 is a top plan view thereof;
 FIG. 9 is a right side elevational view thereof;

FIG. 10 is a top front and right side perspective view of a second embodiment thereof in an operative position;
FIG. 11 is a front elevational view thereof;
FIG. 12 is a top plan view thereof;
FIG. 13 is a left side elevational view thereof;
FIG. 14 is a rear elevational view thereof;
FIG. 15 is a bottom plan view thereof;

FIG. 16 is a top plan view thereof;
FIG. 17 is a front elevational view thereof; and,
FIG. 18 is a right side elevational view thereof.
The display panel is shown in the closed position and the supporting leg is shown in the folded position in FIGS. 7, 8 and 9 and the display panel is shown in the closed position and the carrying handle is shown in the extruded position in FIGS. 16, 17 and 18.

FIG. 1

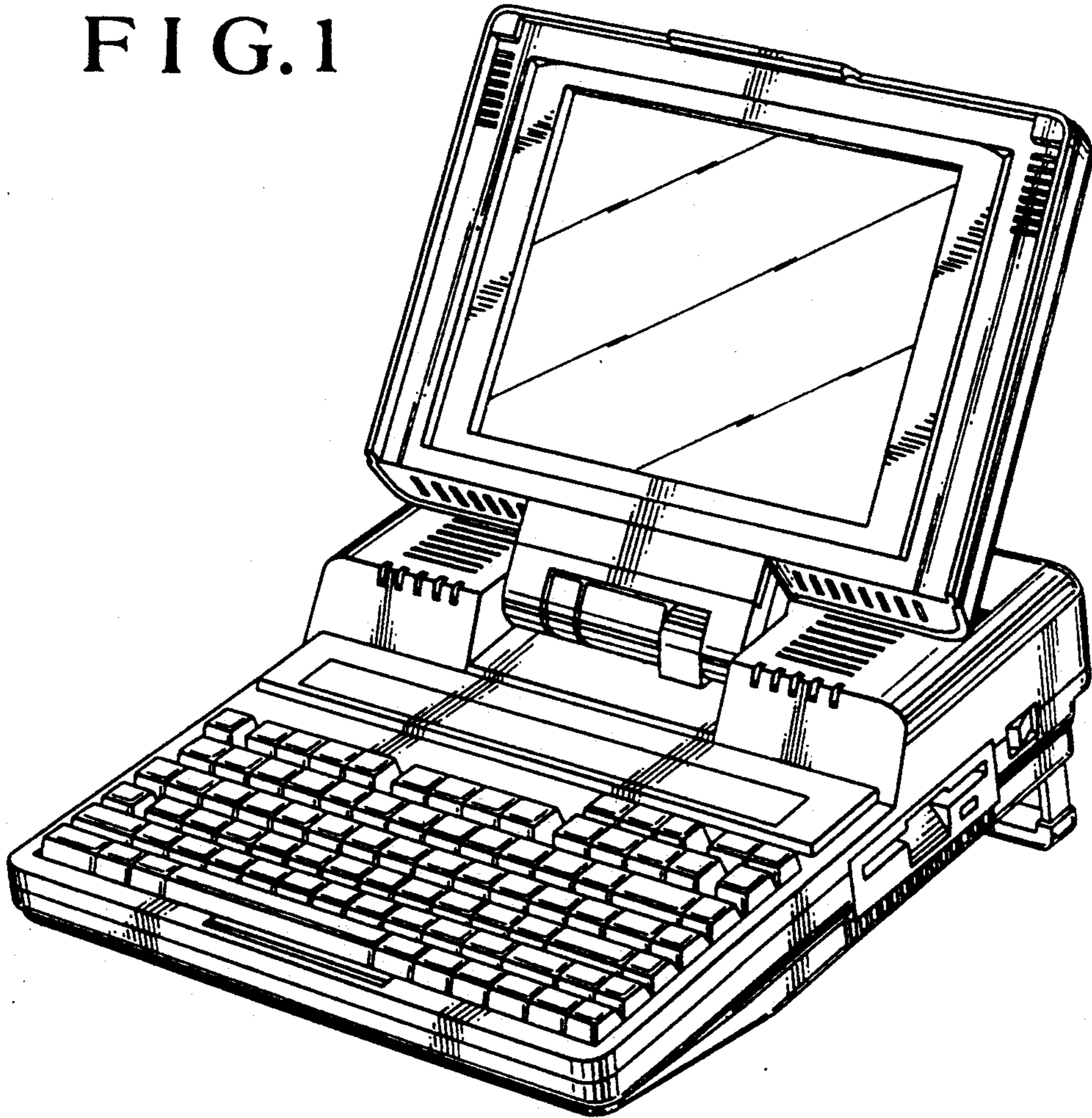

FIG. 2

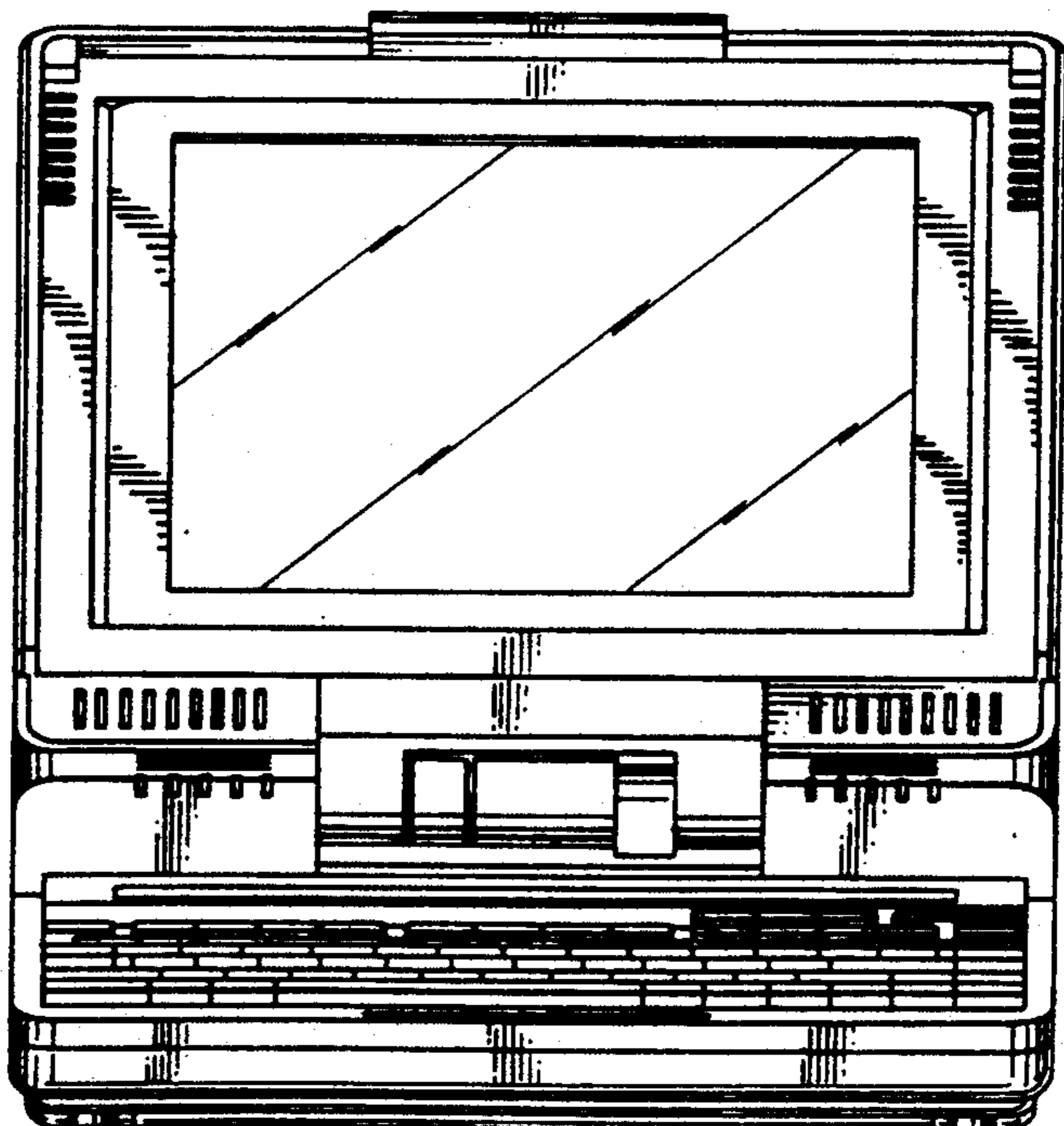

FIG.3

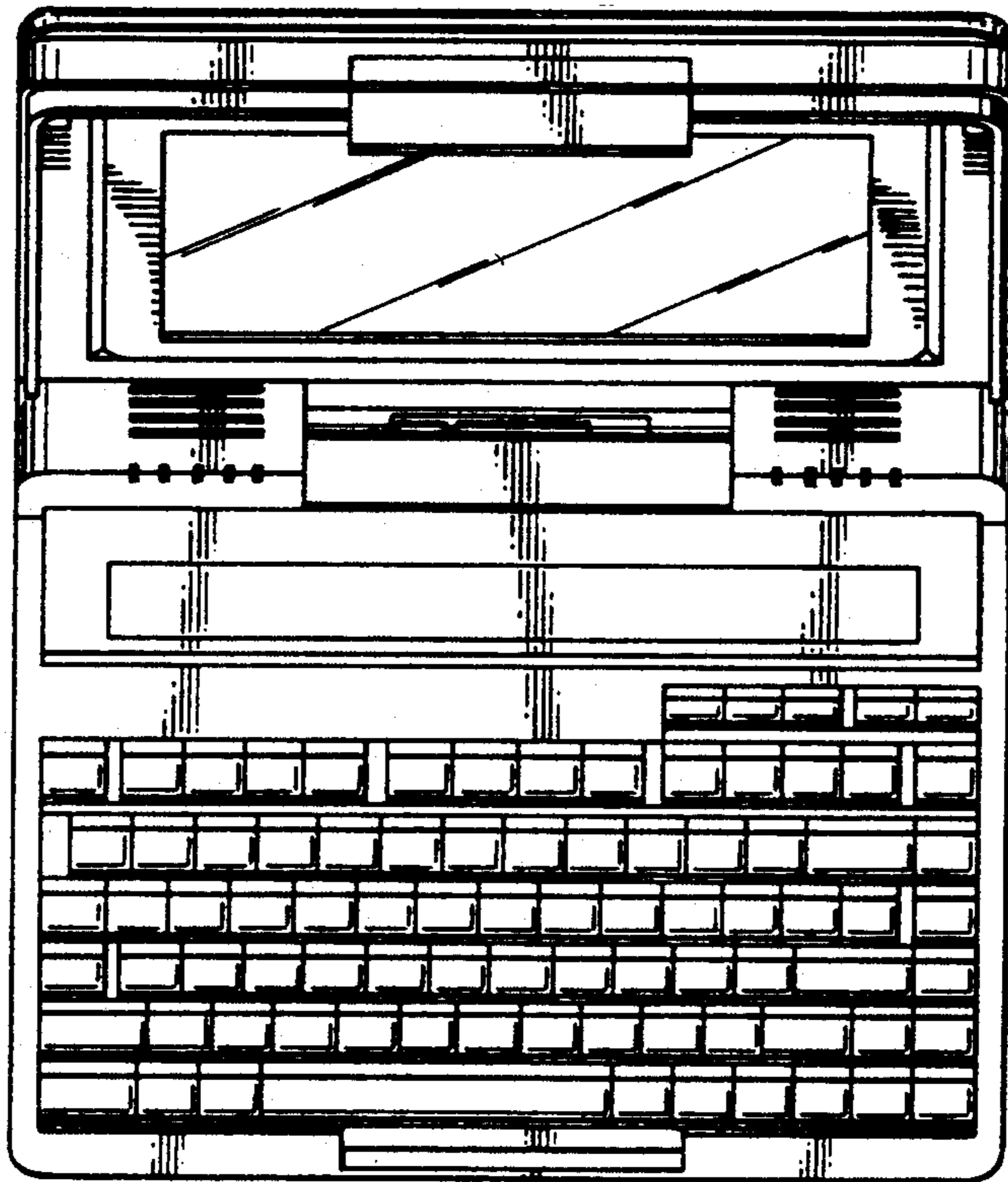

FIG.4

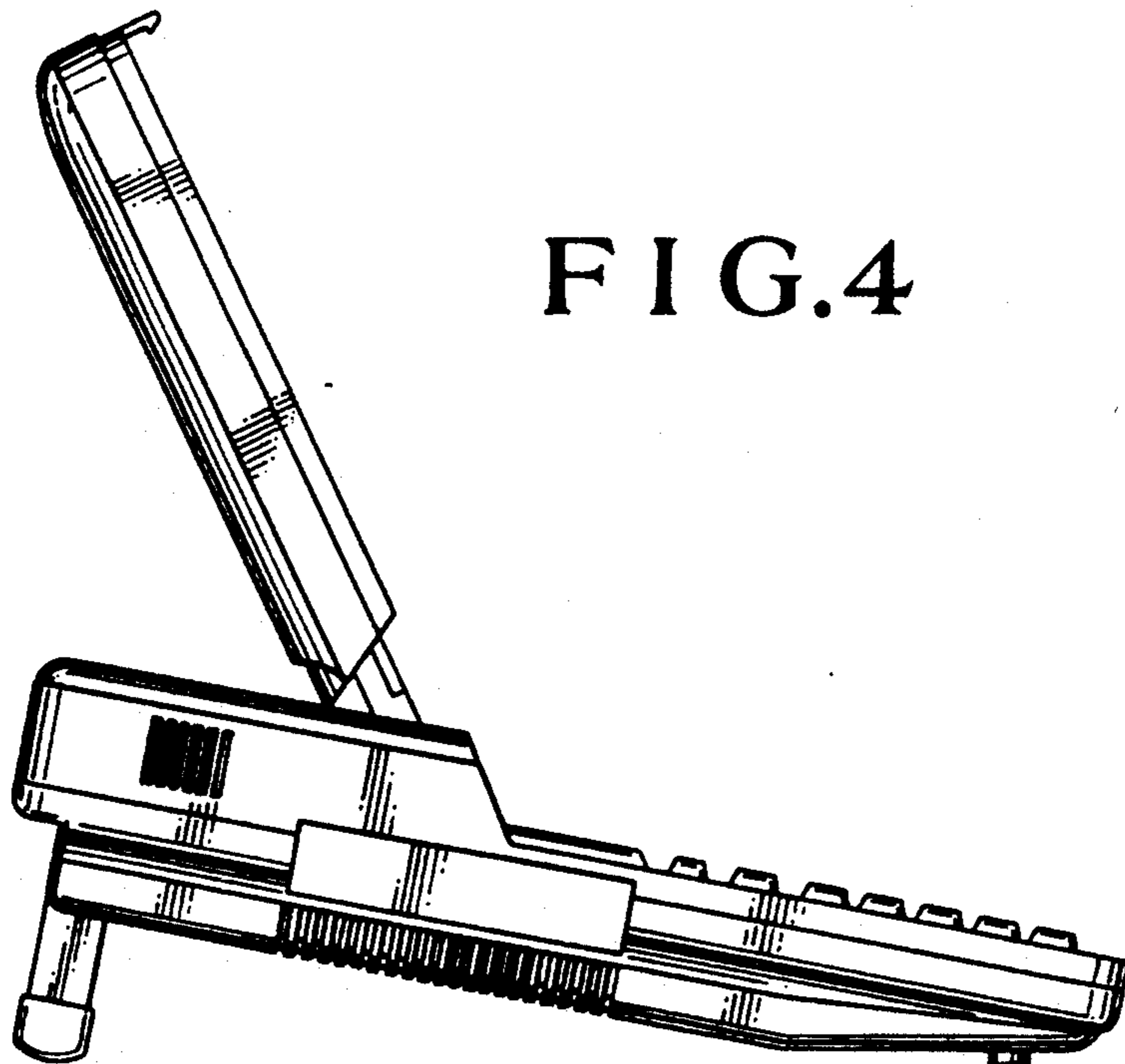

FIG.5

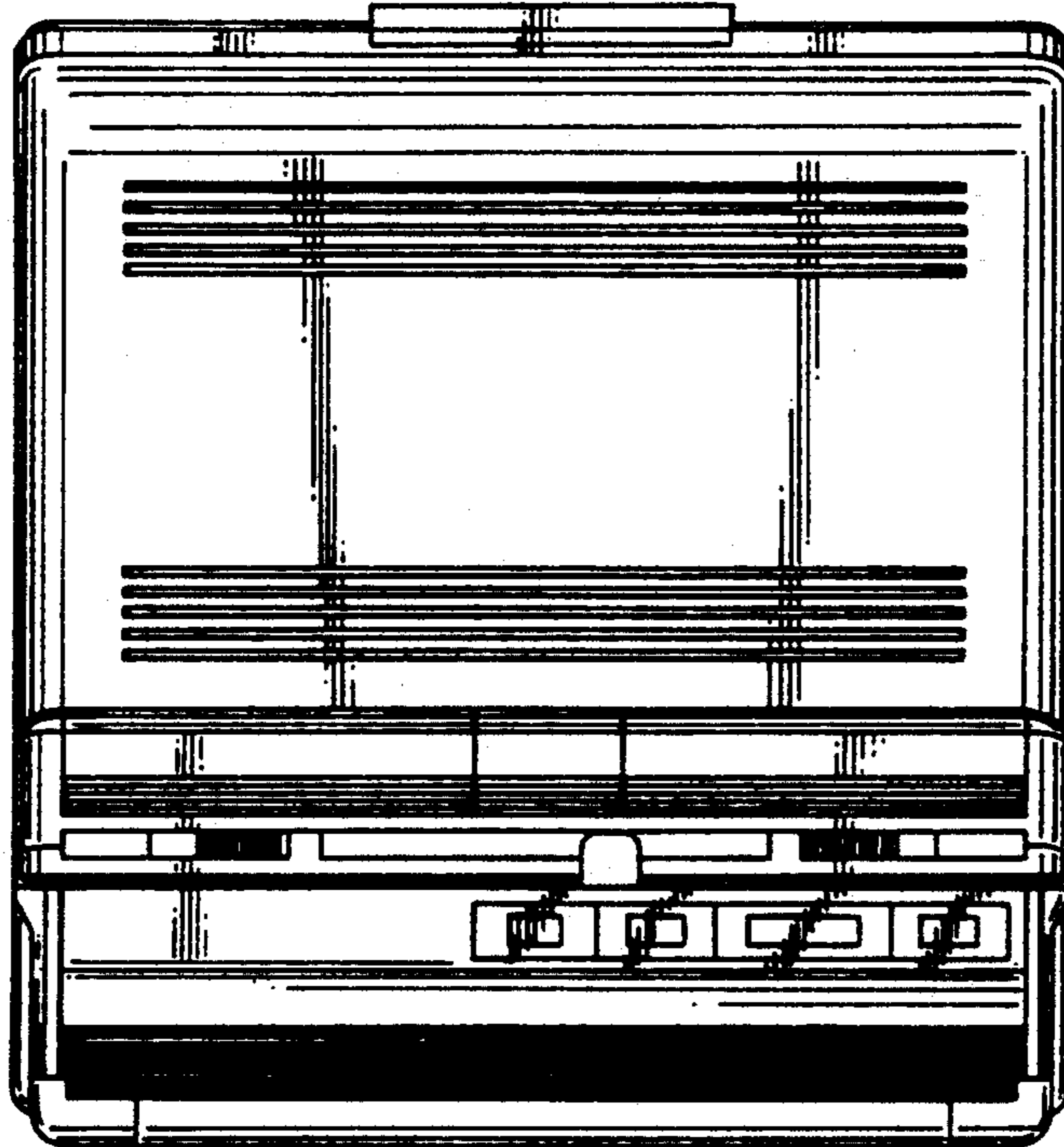

FIG.6

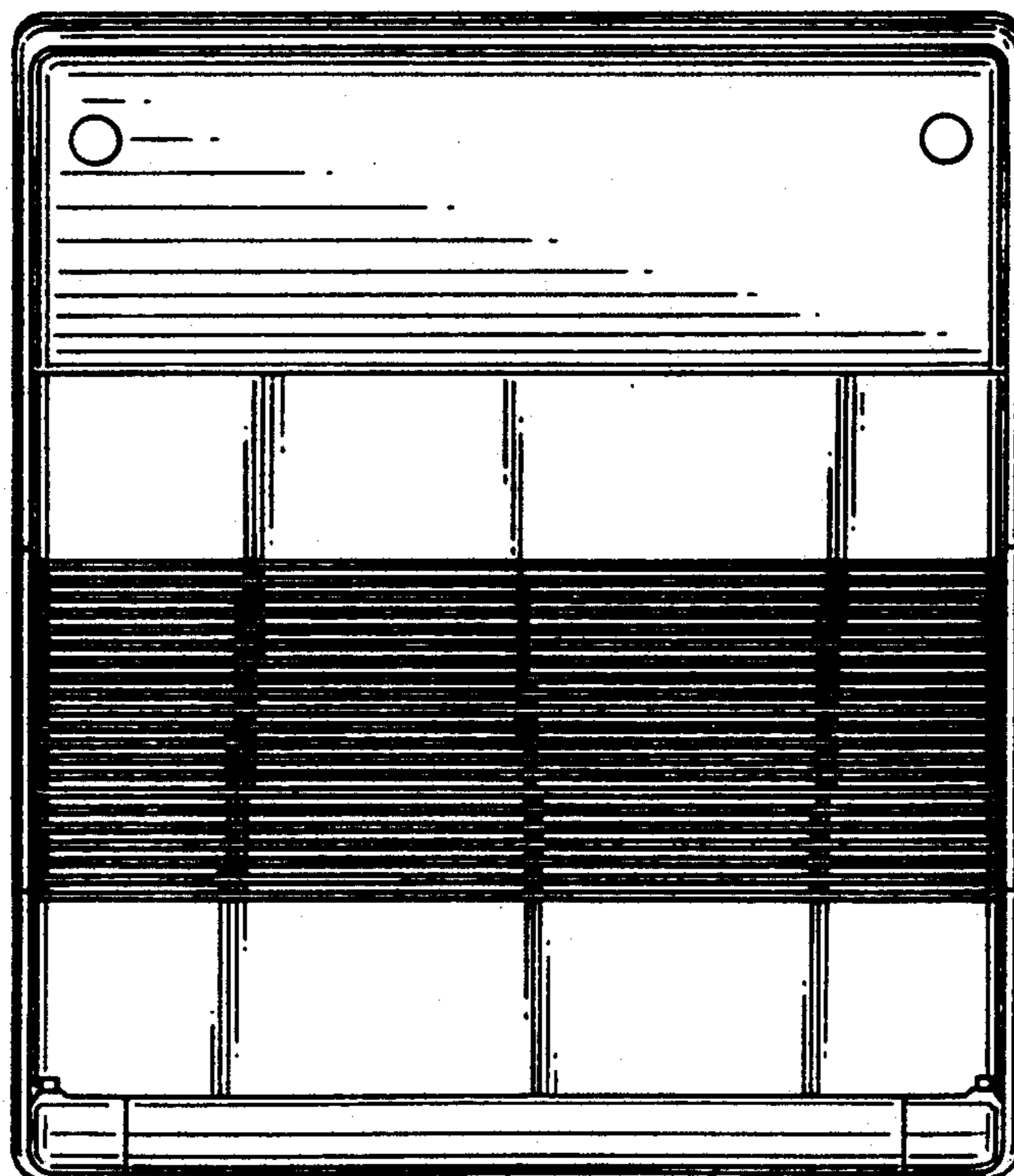

FIG.7

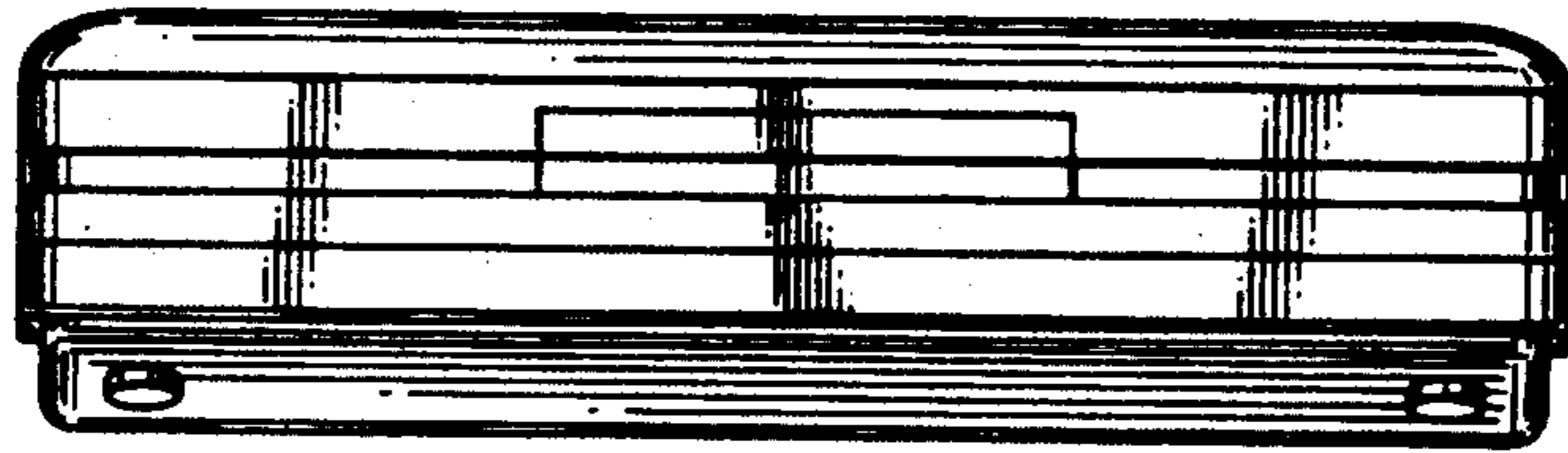

FIG.8

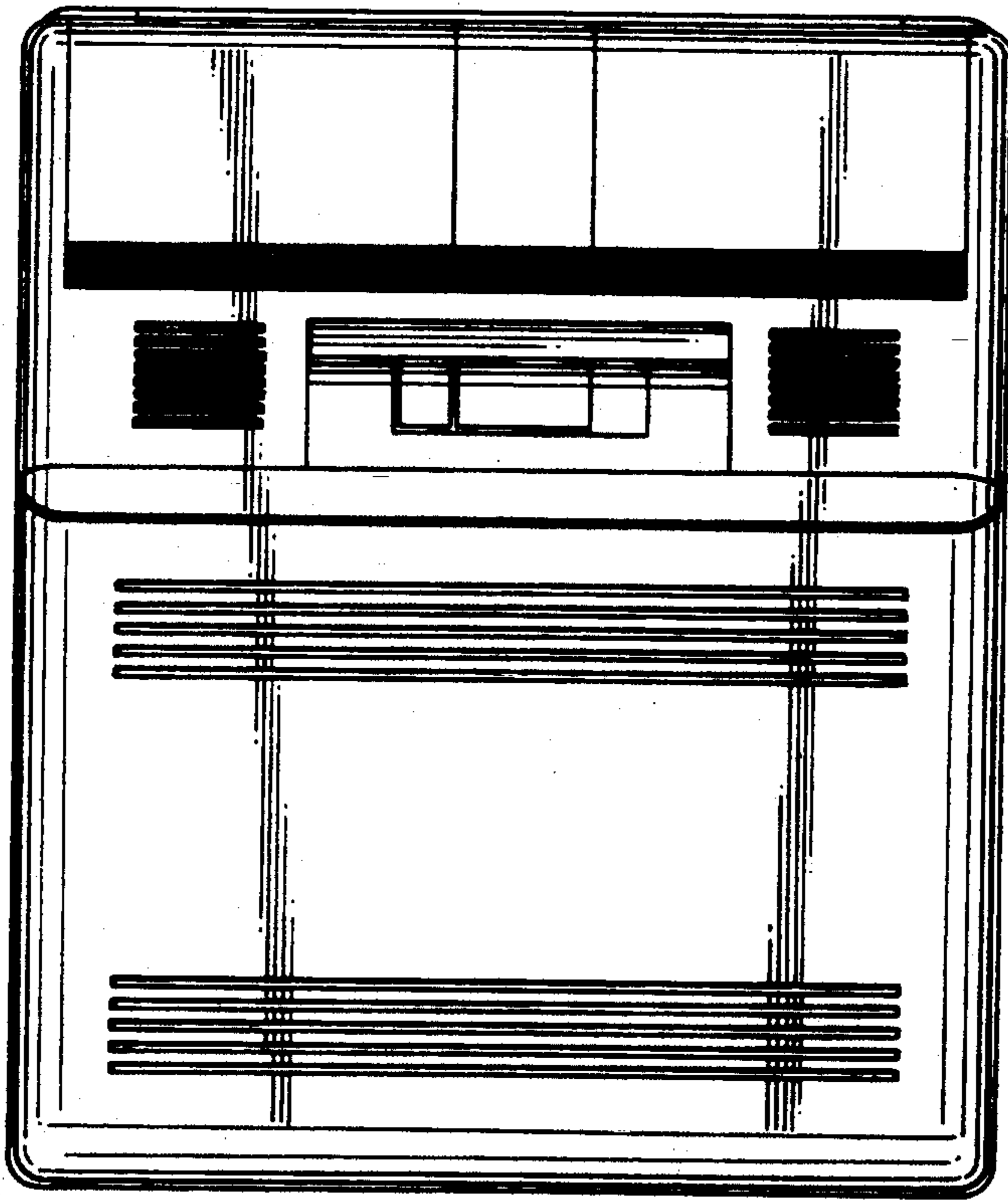

FIG.9

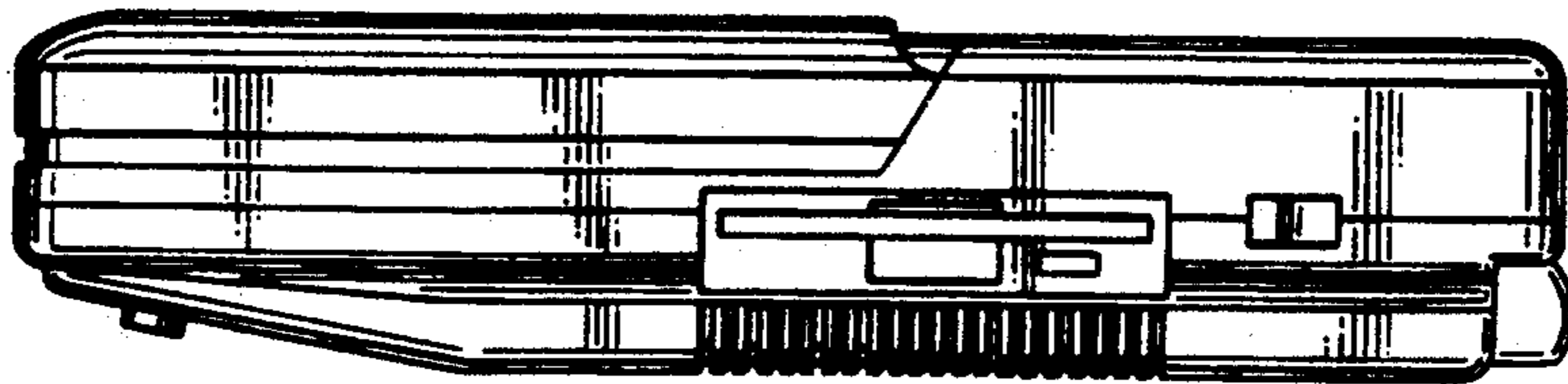

FIG.10

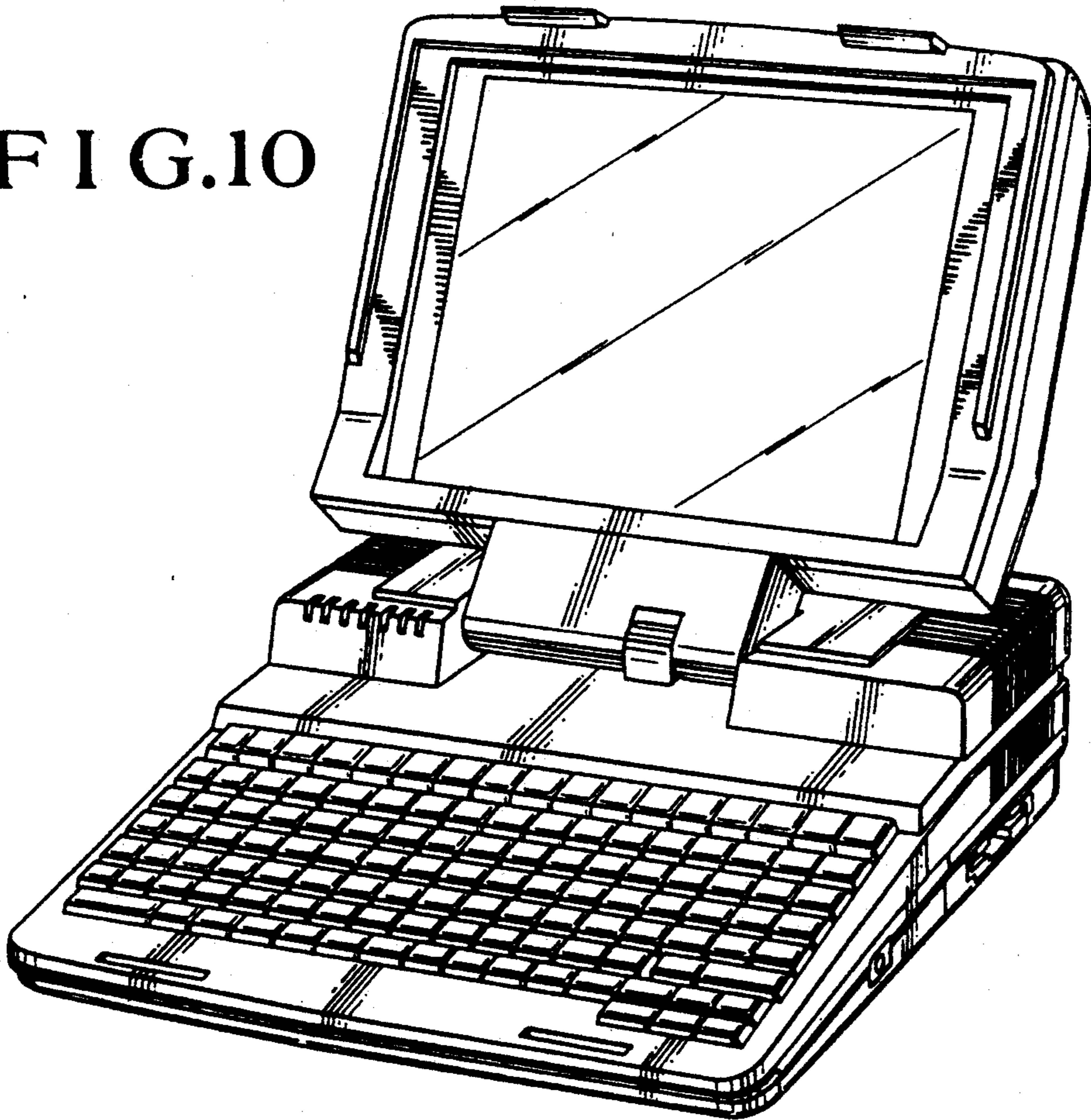

FIG.11

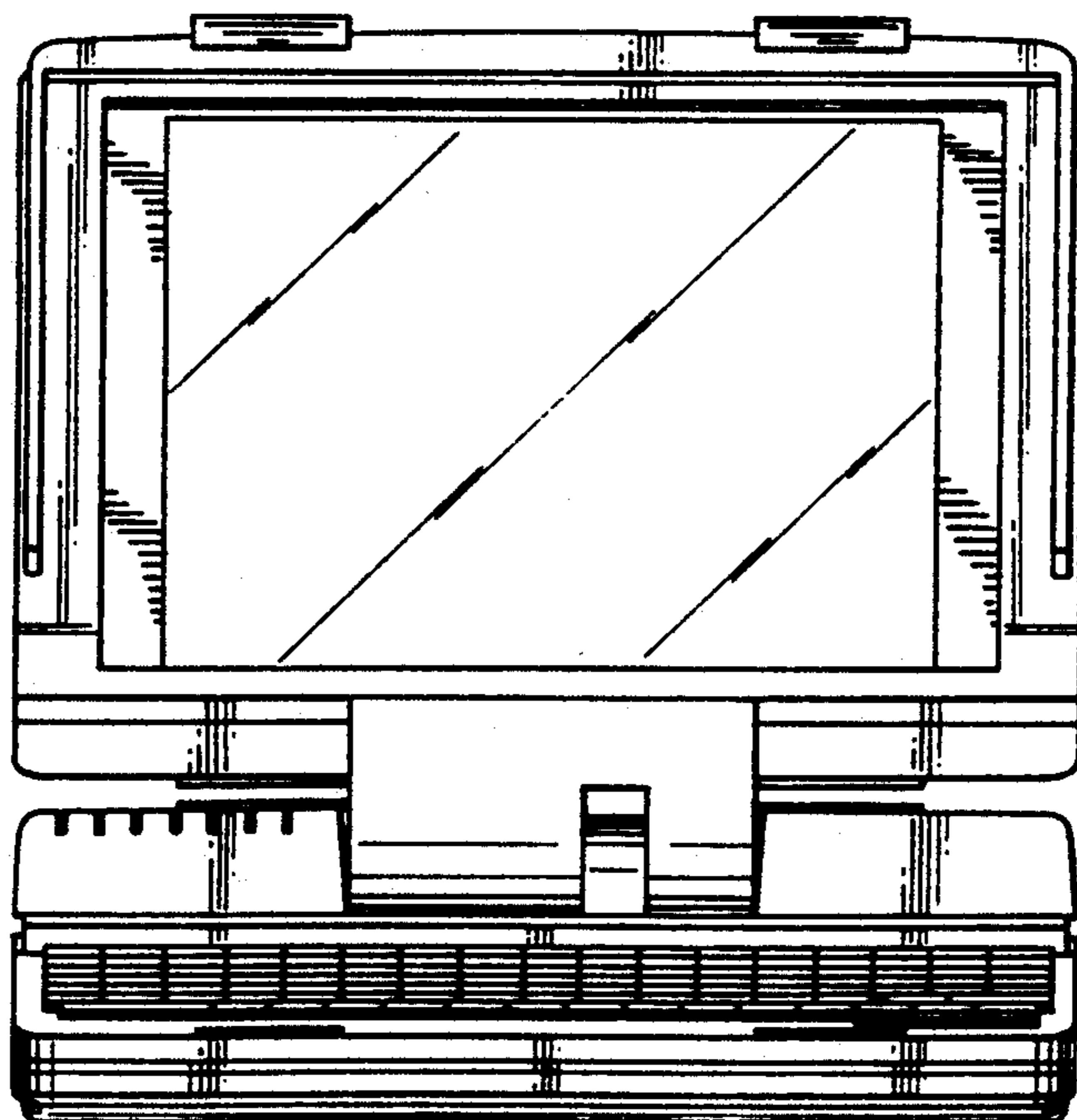

FIG.12

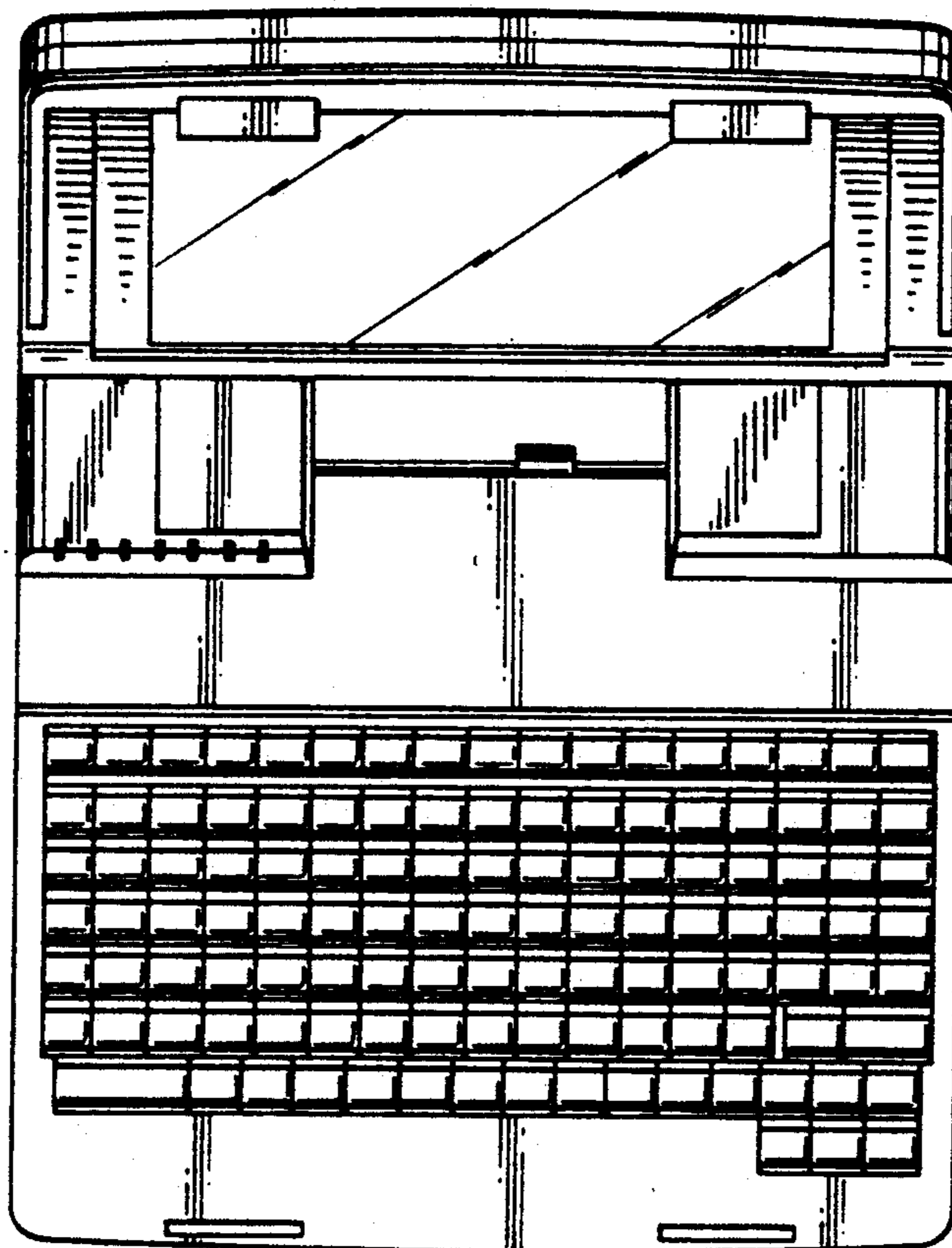

FIG.13

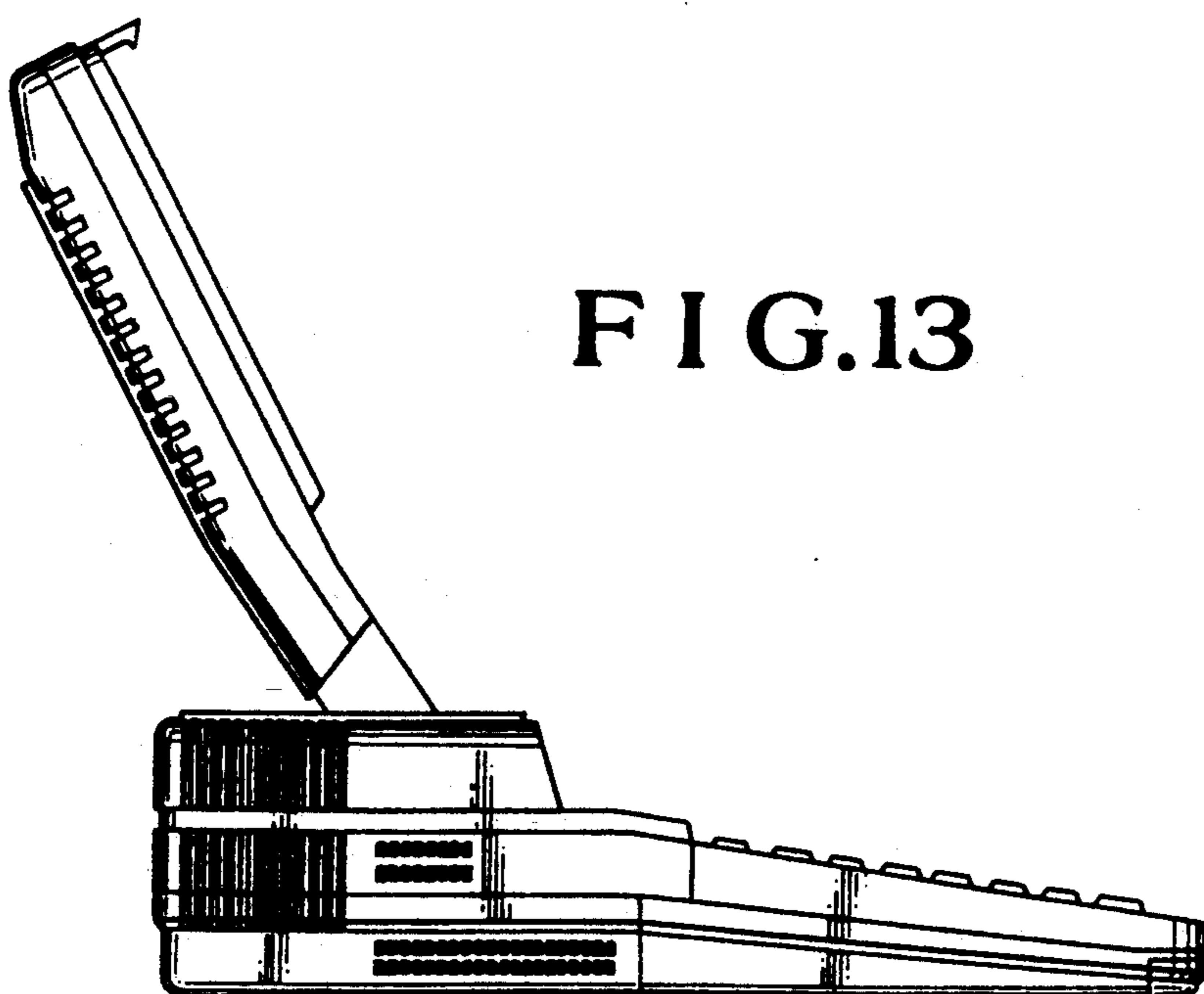

FIG.14

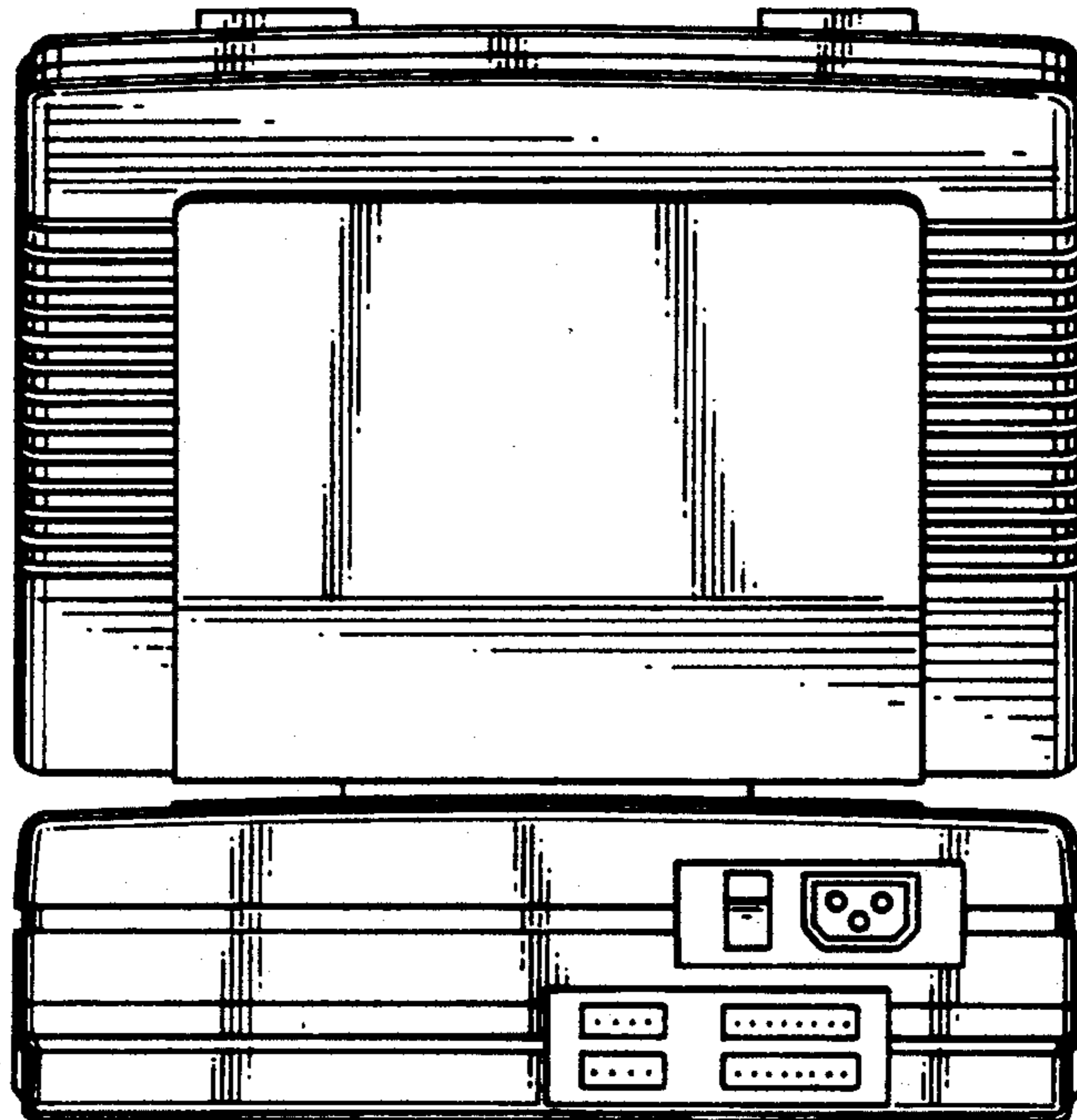

FIG.15

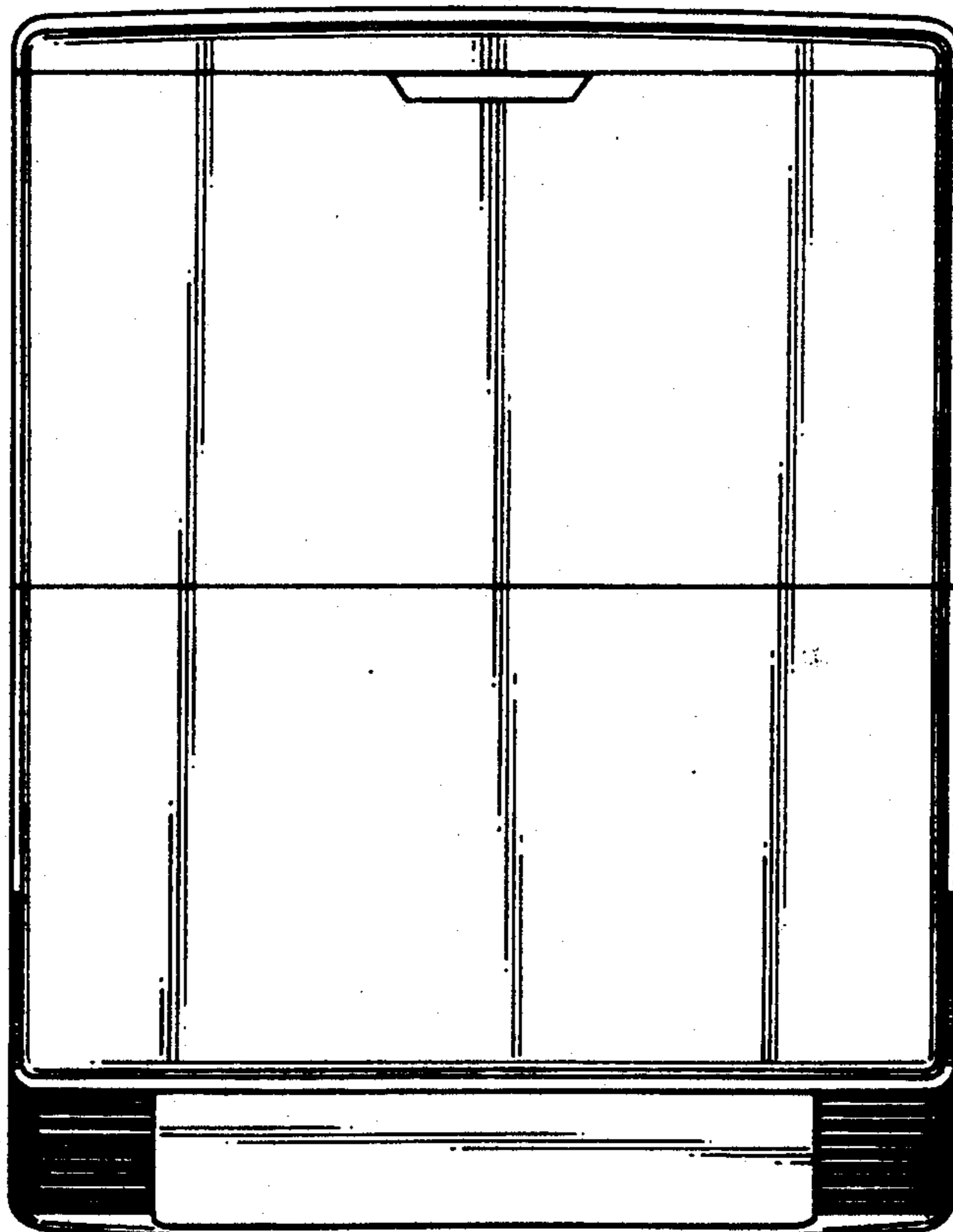

FIG.16

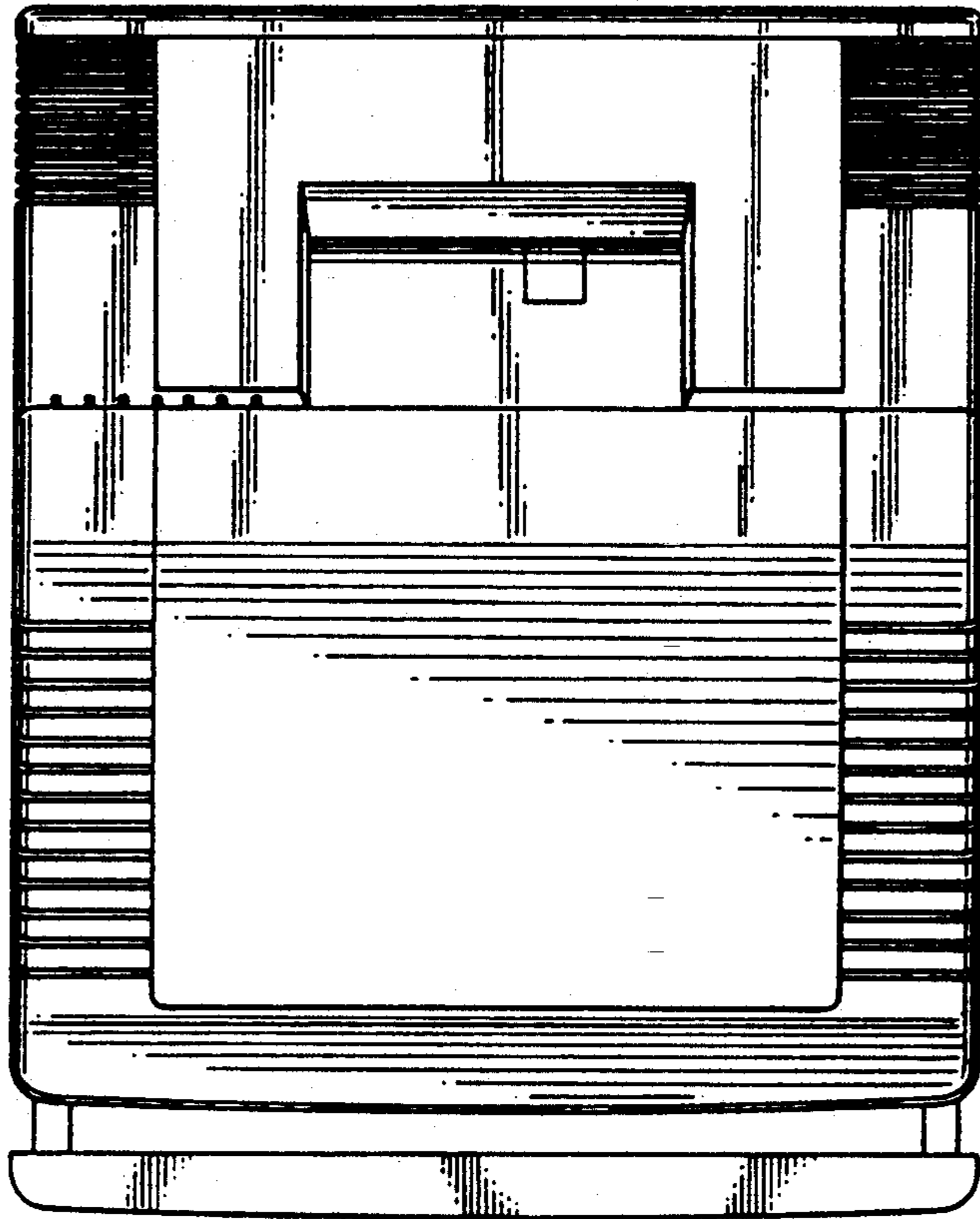

FIG.17

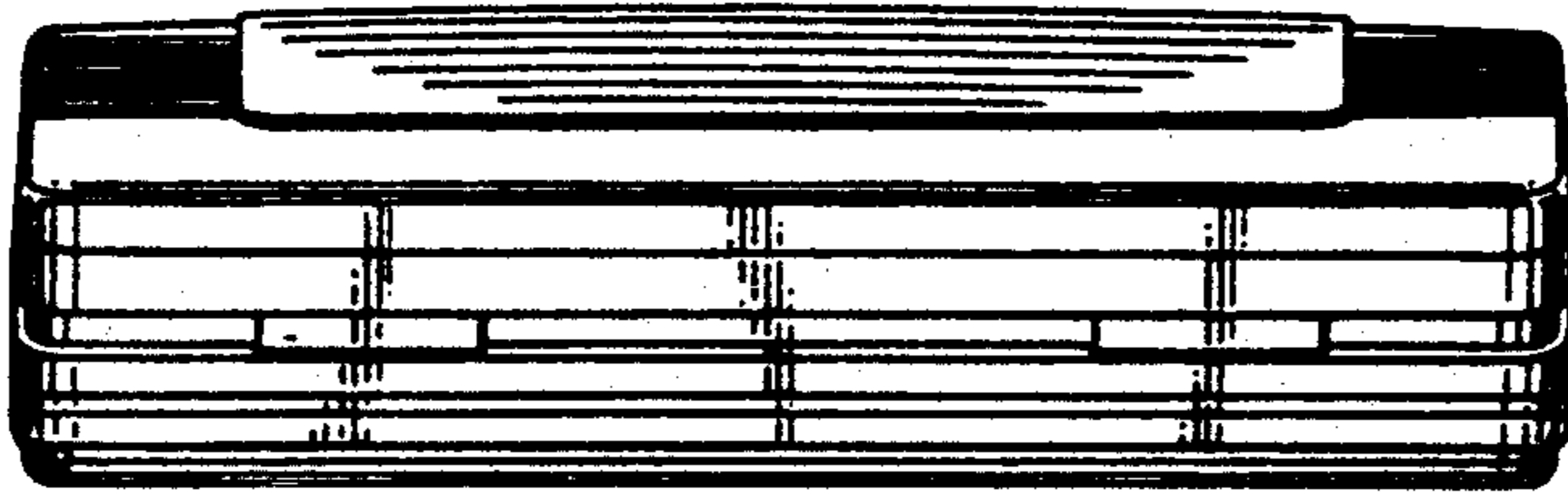

FIG.18

