



US00D337573S

# United States Patent [19]

[11] Patent Number: **Des. 337,573**

**Izaki**

[45] Date of Patent: **\*\* Jul. 20, 1993**

[54] **ELECTRONIC COMPUTER**

[75] Inventor: **Kenzo Izaki, Chiba, Japan**

[73] Assignee: **Kabushiki Kaisha Toshiba, Kanagawa, Japan**

[\*\*] Term: **14 Years**

[21] Appl. No.: **479,600**

[22] Filed: **Feb. 13, 1990**

[30] **Foreign Application Priority Data**

Aug. 29, 1989 [JP] Japan ..... 1-31156

[52] U.S. Cl. .... **D14/106**

[58] Field of Search ..... **D14/100, 101, 105, 106, D14/115, 247; D18/1, 7, 11, 12; 340/700, 706, 711, 712; 341/22, 23; 235/145 A, 145 R; 400/493.1, 494, 472, 473, 485, 488, 489, 486, 693; 364/706-709.09, 900**

[56] **References Cited**

**U.S. PATENT DOCUMENTS**

- D. 224,784 7/1972 Sucre et al. .
- D. 243,250 2/1977 Hazama .
- D. 254,005 1/1980 Zadock et al. .
- D. 269,529 6/1983 Luen .
- D. 275,102 8/1984 MacConnel ..... D14/106
- D. 280,511 9/1985 Moggridge et al. .... D14/106
- D. 280,622 9/1985 Moggridge et al. .... D14/100
- D. 282,843 3/1986 Kurihara et al. .... D14/100
- D. 283,511 4/1986 Dunn ..... D14/106
- D. 284,193 6/1986 Marshall ..... D14/101
- D. 284,474 7/1986 Sawada ..... D14/100
- D. 284,966 8/1986 Larkins ..... D14/100
- D. 287,969 1/1987 Kusanagi ..... D14/106
- D. 288,566 3/1987 Chin et al. .... D14/106
- D. 289,177 4/1987 Sawada ..... D18/7
- D. 289,763 5/1987 Fujii et al. .... D14/106
- D. 290,256 6/1987 Sapper et al. .... D14/106
- D. 290,609 6/1987 Harlan et al. .... D14/100
- D. 290,845 7/1987 Yubisui et al. .... D14/111
- D. 291,442 8/1987 Kurihara ..... D14/106
- D. 293,677 1/1988 Hara et al. .... D14/106
- D. 293,678 1/1988 Sawatani et al. .... D14/106
- D. 294,029 2/1988 Nishiyama et al. .... D14/106
- D. 294,831 3/1988 Hara et al. .... D14/106
- D. 295,176 4/1988 Nishimoto et al. .... D14/106
- D. 295,519 3/1988 Kimble ..... D14/106

- D. 298,623 11/1988 Yubisui et al. .... D14/100
- D. 303,250 9/1989 Ver Nooy et al. .... D14/106
- D. 303,523 9/1989 Shiozawa et al. .... D14/106
- D. 303,790 10/1989 Kato et al. .... D14/106
- D. 304,930 12/1989 Hongo et al. .... D14/100
- D. 305,883 2/1990 Burton ..... D14/106
- D. 306,285 2/1990 Yu ..... D14/106
- D. 307,581 5/1990 Ooshima ..... D14/106
- D. 308,050 5/1990 Sugano et al. .... D14/106
- D. 308,051 5/1990 Sakai ..... D14/106
- D. 308,516 6/1990 Takach, Jr. et al. .... D14/106
- D. 308,860 6/1990 Tsukada et al. .... D14/106
- D. 308,861 6/1990 Tsukada et al. .... D14/106
- D. 309,603 7/1990 Mizusugi et al. .... D14/106
- D. 309,749 8/1990 Ido ..... D18/7
- D. 310,353 9/1990 Sugano et al. .... D14/106
- D. 310,828 9/1990 Gundstrom et al. .... D14/106
- D. 311,527 10/1990 Fujii et al. .... D14/106
- D. 311,528 10/1990 Sugano et al. .... D14/106
- D. 311,741 10/1990 Sakai ..... D14/106
- D. 311,906 11/1990 Iino ..... D14/106
- D. 312,822 12/1990 Watabe et al. .... D14/106
- D. 313,978 1/1991 Miyakuni ..... D14/106
- D. 313,978 1/1991 Miyakuni ..... D14/106
- D. 314,558 2/1990 Iino ..... D14/106
- D. 317,444 6/1991 Mizusugi et al. .... D14/106
- D. 322,246 12/1991 Izaki ..... D14/100
- D. 323,156 1/1992 Nishida ..... D14/101
- D. 324,036 2/1992 Wakasa ..... D14/101
- D. 324,305 2/1992 Izaki ..... D14/100
- 4,703,160 10/1987 Narishima et al. .... 235/1 D

**FOREIGN PATENT DOCUMENTS**

- 100708 6/1988 China .
- 100709 6/1988 China .
- 101093 7/1988 China .
- M8800660 10/1988 Fed. Rep. of Germany .
- M8803410 12/1989 Fed. Rep. of Germany .
- M8803411 12/1989 Fed. Rep. of Germany .
- M8908516 7/1990 Fed. Rep. of Germany .
- 47-14961 5/1972 Japan .
- 499866 4/1979 Japan .
- 639216 11/1984 Japan .
- 650470 5/1985 Japan .
- 664175 10/1985 Japan .
- 684172 8/1986 Japan .
- 684172 8/1986 Japan .
- 685000 8/1986 Japan .
- 685063 8/1986 Japan .
- 685121 8/1986 Japan .

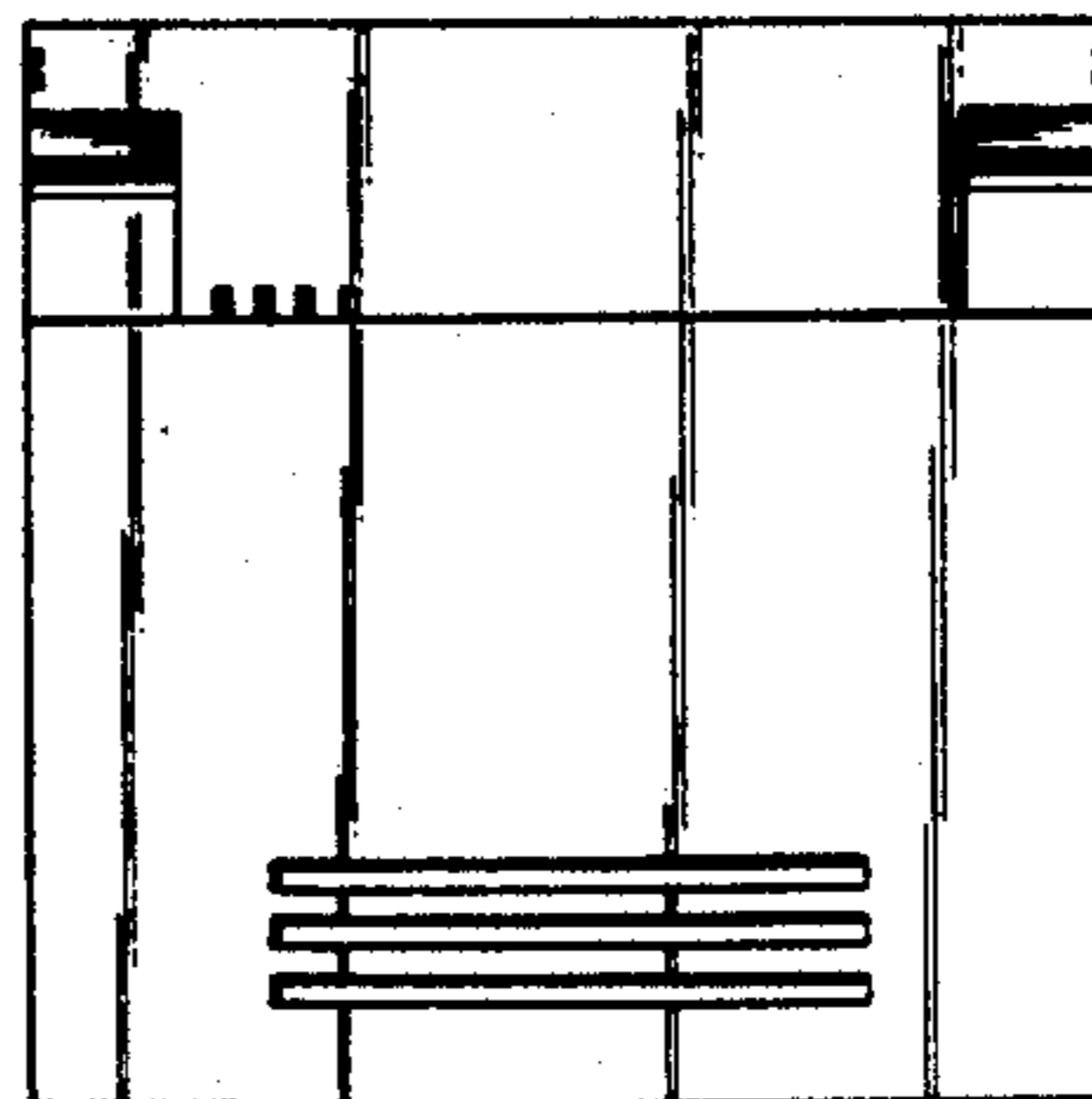
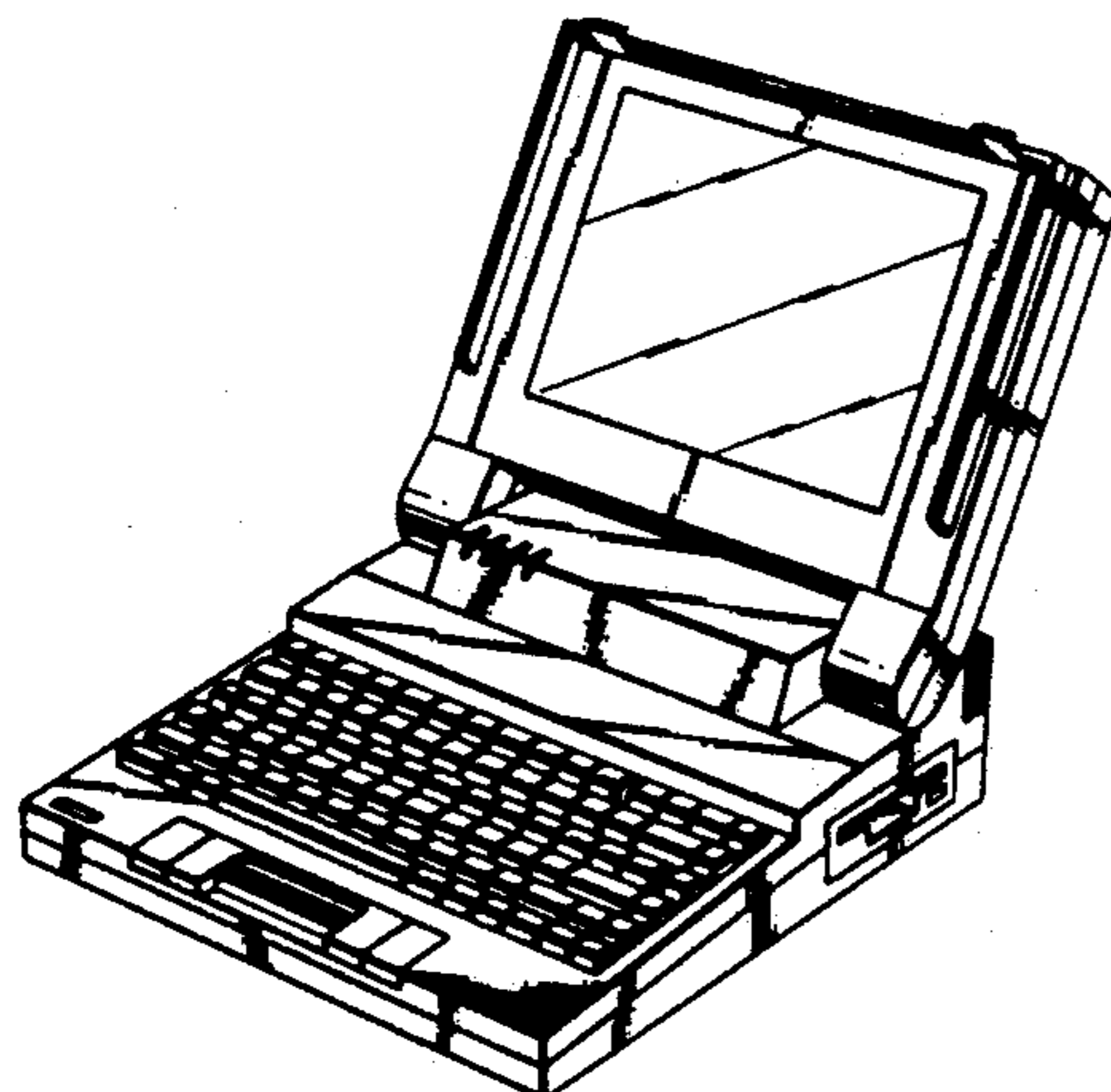

685542	8/1986	Japan .	Apple Computer Apple IIC Oct. 15, 1984.
686374	9/1986	Japan .	TI Software Journal, Pro-Lite ® Nov. 14, 1984.
686381	9/1986	Japan .	IS-11c Advertisement Nov. 14, 1984.
686386	9/1986	Japan .	Dulmont Magnum Article in Portable Computer Nov. 1984.
686654	9/1986	Japan .	IBM Advertisement Dec. 1984.
686658	9/1986	Japan .	Tandy 200 1985.
686706	9/1986	Japan .	General Corp. 4400 Jan. 14, 1985.
685000	12/1986	Japan .	AVAL TM Advertisement Feb. 11, 1985.
695931	12/1986	Japan .	Picture #J60007802 Feb. 26, 1985.
696188	1/1987	Japan .	AVAL TM20 Mar. 8, 1985.
697328	1/1987	Japan .	Tandy 200 Mar. 16, 1985.
763838	6/1988	Japan .	NEC Starlet PC-8401A Brochure Mar. 28, 1985.
685121	10/1988	Japan .	C & D News Mar. 29, 1985.
747990	11/1988	Japan .	Hewlett-Packard HP110 Apr. 1985.
747991	11/1988	Japan .	Fujitsu FM 16 Apr. 17, 1985.
748513	11/1988	Japan .	Fujitsu FM16 TL Brochure May 22, 1985.
749802	11/1988	Japan .	Data General One Brochure May 23, 1985.
746985(1)	4/1989	Japan .	Toshiba T 1100 Plus Jul. 22, 1985.
746985(2)	4/1989	Japan .	Minato Electronics MODS-5000 Aug. 22, 1985.
761927	5/1989	Japan .	GridCase Brochure Sep. 24, 1985.
763840	6/1989	Japan .	FBS Advertisement Oct. 30, 1985.
763855	6/1989	Japan .	NEC N6919 Model 80/80H Nov. 11, 1985.
761927(1)	2/1990	Japan .	IBM Advertisement Nov. 28, 1985.
761927(3)	5/1990	Japan .	Apple Computer IIC Dec. 1985.
761927(2)	5/1990	Japan .	Hewlett-Packard Portable Plus Dec. 1985.
761927(4)	6/1990	Japan .	FLM-700 Jan. 31, 1986.
67297	2/1987	Rep. of Korea .	Fujitsu FM 16 May 21, 1986.
85031	10/1988	Rep. of Korea .	PC-816F Advertisement May 27, 1986.
85032	10/1988	Rep. of Korea .	Zenith Data Systems NewsDate Newsletter Jun. 7, 1986.
92859	7/1989	Rep. of Korea .	Tandy 600 Advertisement Jul. 25, 1986.
92863	7/1989	Rep. of Korea .	Ricoh JP70D Brochure Sep. 29, 1986.
94970	9/1989	Rep. of Korea .	Data General One Brochure Oct. 3, 1986.

## OTHER PUBLICATIONS

Sharp Advertisement May 19, 1976.	Article re IBM Portable Personal Computer Oct. 15, 1986.
Fanuc System P-Model Jul. 27, 1983.	NEC PC-98LT Advertisement Oct. 23, 1986.
Moebel Interior Design Jan. 5, 1984.	Yaskawa P-t50 Advertisement Nov. 12, 1986.
The Office 98-6 Jan. 31, 1984.	Yaskawa Memocon ®-SC GL20 Advertisement Mar. 27, 1987.
Demus 645 Feb. 22, 1984.	TI Advertisement in Telephony Apr. 1, 1987.
MRD Advertisement Mar. 29, 1984.	Data General One Model 2J Brochure May 20, 1987.
Gavilan Mobile Computer Brochure Apr. 19, 1984.	Hitachi B16LX Brochure Aug. 31, 1987.
Picture #JP9016870 May 8, 1984.	Ricoh Brochure Sep. 17, 1987.
Hewlett Packard Advertisement May 18, 1984.	Sony Produce 100 Brochure Sep. 18, 1987.
Hewlett Packard Advertisement Jun. 5, 1984.	Panasonic FW-U1EX Advertisement Oct. 2, 1987.
Epson HC-88 Jul. 1, 1984.	
Hitachi Advertisement Sep. 4, 1984.	
Hewlett Packard Advertisement Sep. 12, 1984.	
Sharp PC-5000 Brochure Sep. 26, 1984.	
Data General One Advertisement Sep. 28, 1984.	

Nihon IBM 55 Model 5535 Oct. 19, 1987.  
 NEC Minitel 5 Advertisement Oct. 29, 1987.  
 Rein Laptop 300 SLC Advertisement Oct. 29, 1987.  
 IBM 5540/5535 Brochure Nov. 4, 1987.  
 NEC PC-9800 Advertisement Nov. 27, 1987.  
 Panasonic U1EX Advertisement Dec. 8, 1987.  
 Schneider Multivision 300 SLC Catalog 1988.  
 Panasonic U1Pro Jan. 4, 1988.  
 Diagnostic Products Review Jan. 2, 1988.  
 Toshiba E & E News Feb. 26, 1988.  
 Seiko-Epson PC-286L Mar. 2, 1988.  
 Toshiba JW90FII Rupo Brochure Mar. 3, 1988.  
 Hitachi B16LX Brochure Apr. 5, 1988.  
 Sony Produce PJ-100EX Brochure Apr. 5, 1988.  
 WS Japanese Advertisement Apr. 27, 1988.  
 NEC Multispeed Spring 1988.  
 Samsung S5200 May 10, 1988.  
 Datavue Snap 1+1 May 10, 1988.  
 Portable Computer Review, p. 32 May 10, 1988.  
 GridCase 1530 Advertisement May 10, 1988.  
 NEC MultiSpeed EL Model 2 Brochure May 10, 1988.  
 Sharp PC-5000 Brochure May 12, 1988.  
 Japanese Advertisement May 12, 1988.  
 Sanyo ES 100 May 13, 1988.  
 NEC PC-9801 LV 21 Brochure May 13, 1988.  
 Sharp WV-500 May 19, 1988.  
 Panafacom C-250 LT Brochure May 19, 1988.  
 Sony Produce 100EX Advertisement May 19, 1988.  
 Panasonic Panacom 6000 LT Brochure Jun. 7, 1988.  
 NEC Mini 5 Carryword Brochure Jun. 27, 1988.  
 Ricoh JP90LX Brochure Jun. 28, 1988.  
 NEC Mini 5 HL Brochure Jun. 30, 1988.  
 NEC PC-98 LT Brochure Jul. 14, 1988.  
 Kyosera 386AX Sep. 1988.  
 NEC PC-9801 Oct. 26, 1988.  
 Sanyo MBC-17LTJ Oct. 1988.  
 Toshiba T 1600 Nov. 1988.  
 Sanyo MBC 17LTJH Nov. 28, 1988.  
 Oki "IF 386 AX" Dec. 9, 1988.  
 Kyosera 386-SX Laptop AX Jan. 10, 1989.  
 Seiko-Epson PC-286LS Feb. 16, 1989.

NEC PC-9801 LV21 May 13, 1989.  
 Fujitsu G-150LT May 19, 1989.  
 Visual Computer Brochure.  
 Gavilan Mobile Computer Brochure.  
 Olivetti Personal Computer M15 Brochure.  
 Epson HC-88, HC80 Brochure.  
 Epson PX-8 Personal Computer Brochure.  
 Mitsubishi mp286L Laptop Personal Computer Brochure.  
 Grid Brochure.  
 Dauphin Laptop Computer Brochure.  
 MicroDIRECT Brochure.  
 SuperSport Brochure.  
 Panasonic KX-D4930 Advertisement.  
 Ampere WS-1 Advertisement.  
 NEC Contrast.  
 NEC Starlet PC-8401A Advertisement.  
 Victor Technologies, V 286 P Catalog.

*Primary Examiner*—Wallace R. Burke  
*Assistant Examiner*—F. Nunn  
*Attorney, Agent, or Firm*—Banner, Birch, McKie & Beckett

[57]

**CLAIM**

The ornamental design for an electronic computer, as shown and described.

**DESCRIPTION**

FIG. 1 is a top, front and right side perspective view of an electronic computer showing my new design;  
 FIG. 2 is a front elevational view thereof;  
 FIG. 3 is a rear elevational view thereof;  
 FIG. 4 is a top plan view thereof;  
 FIG. 5 is a bottom plan view thereof;  
 FIG. 6 is a left side elevational view thereof;  
 FIG. 7 is a front elevational view thereof, the display panel in the closed position;  
 FIG. 8 is a right side elevational view thereof, the display panel in the closed position; and,  
 FIG. 9 is a top plan view thereof, the display panel in the closed position.

FIG. 1

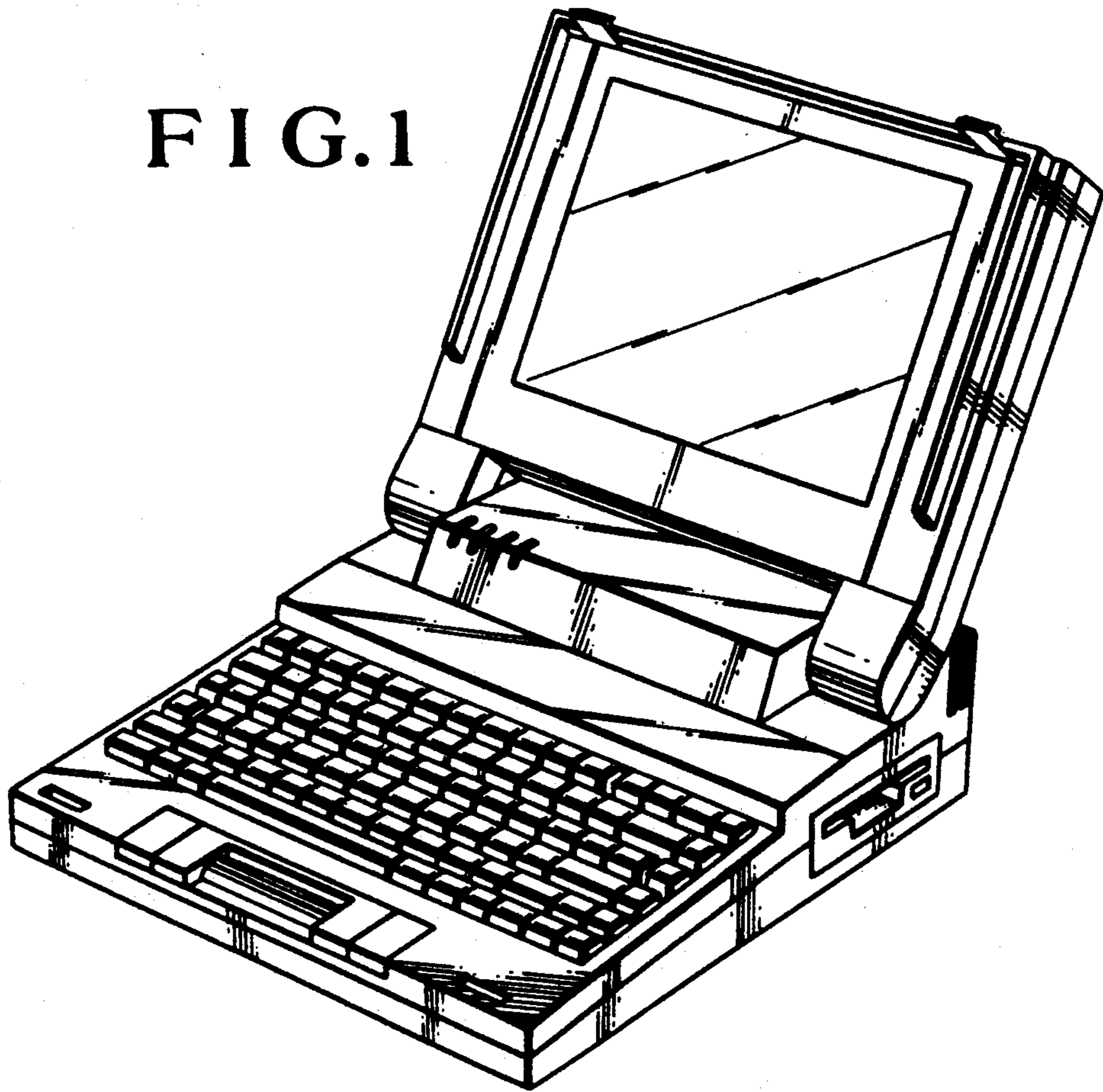

FIG. 2

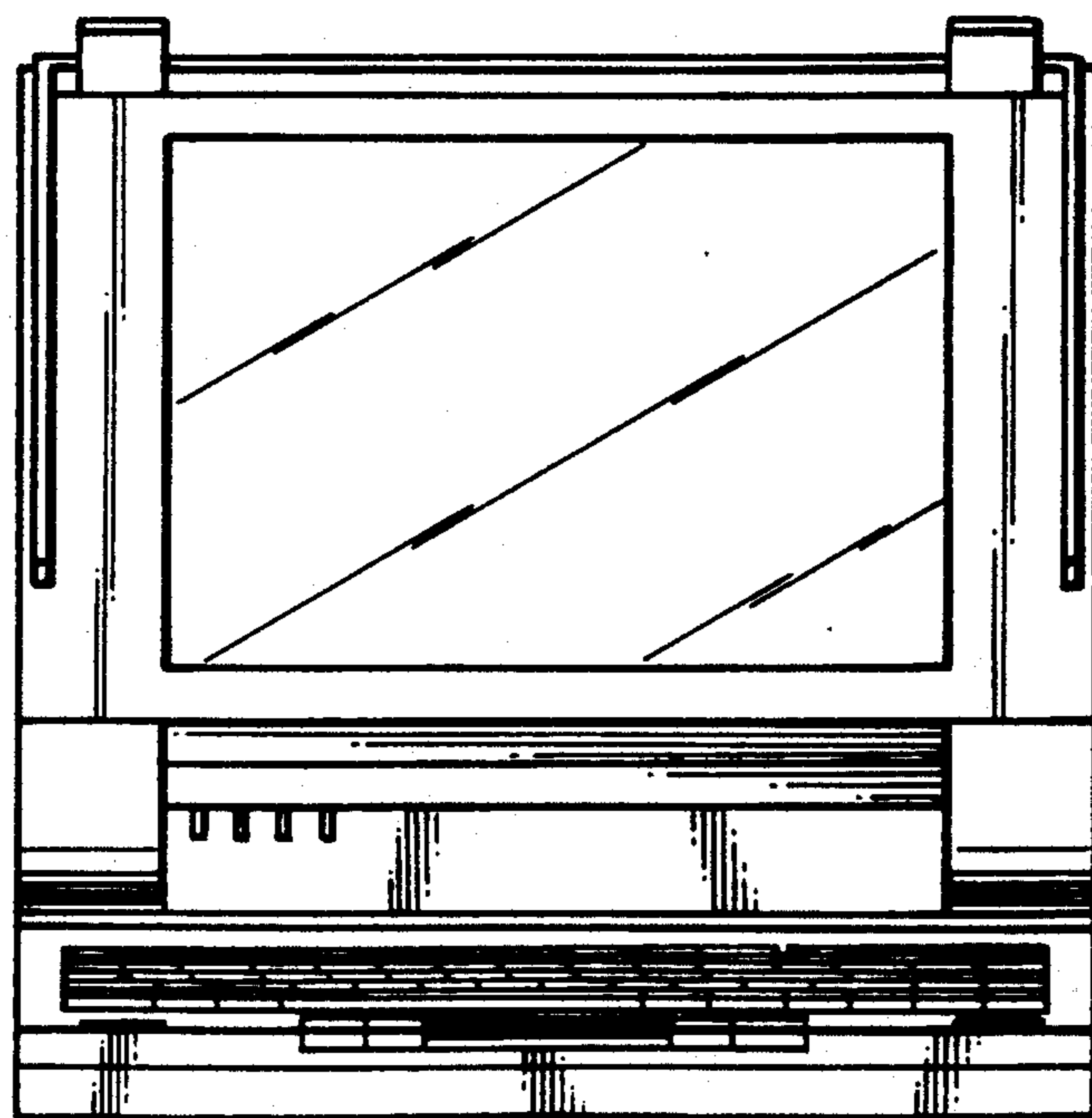

FIG.3

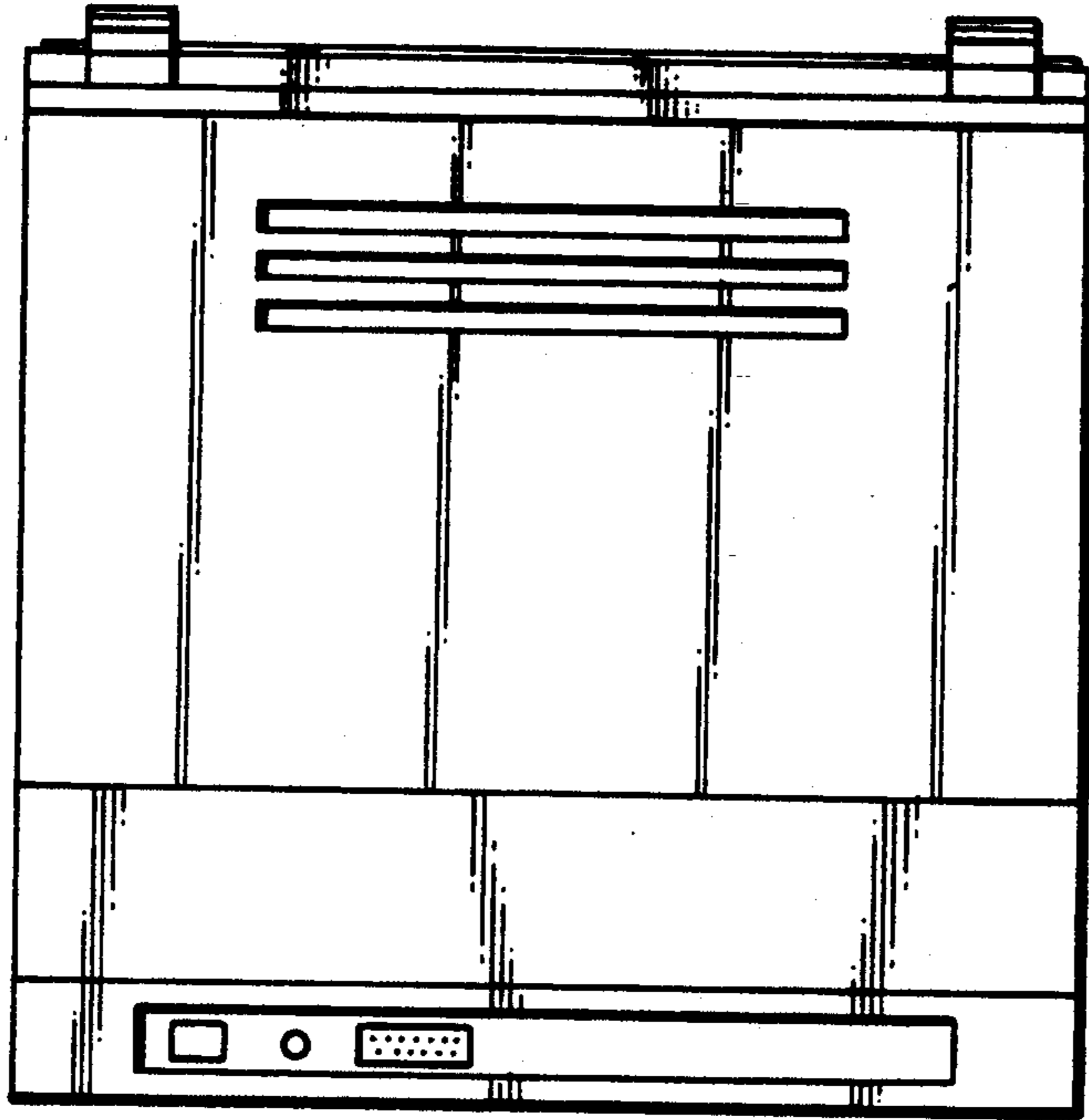

FIG.4

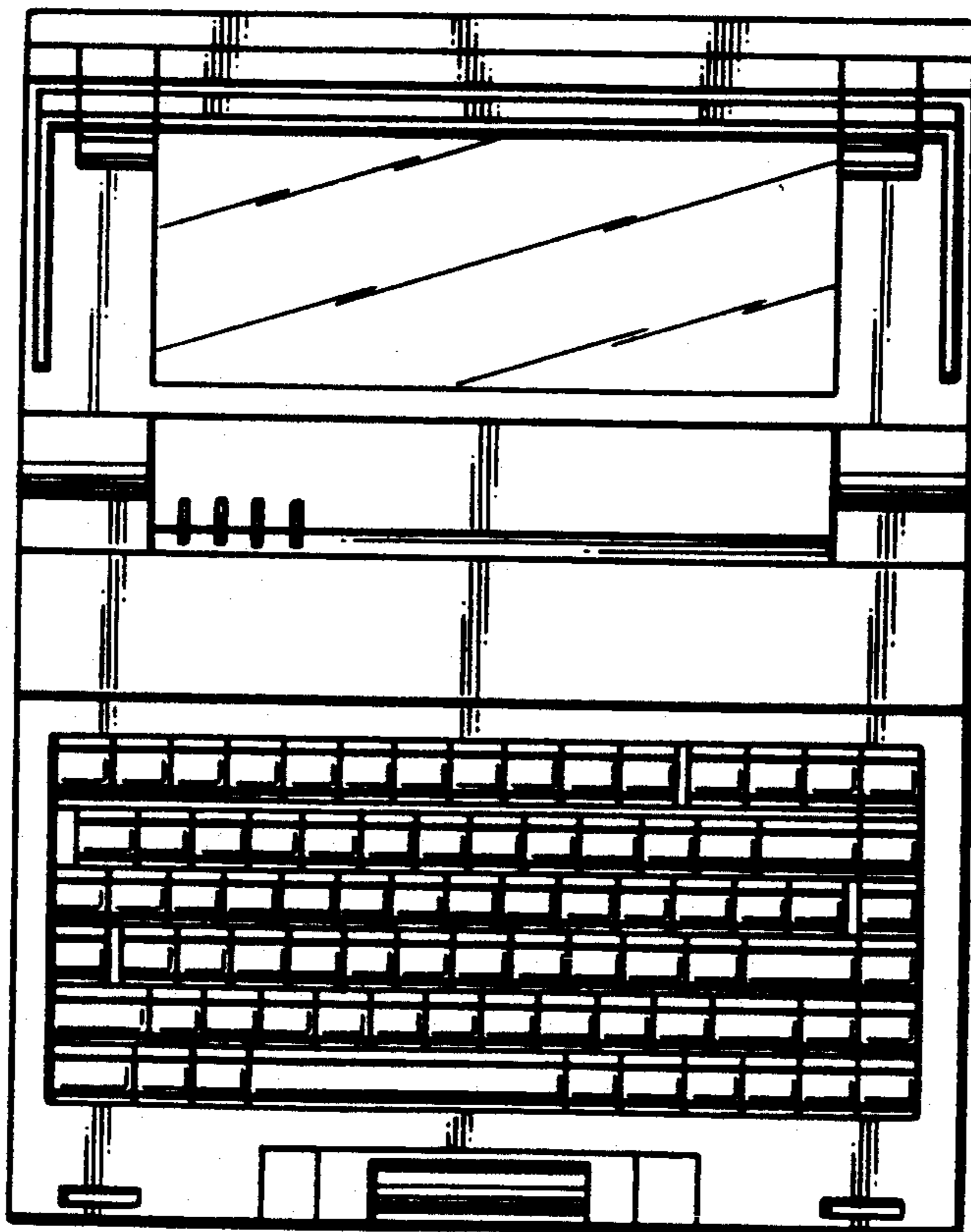

FIG.5

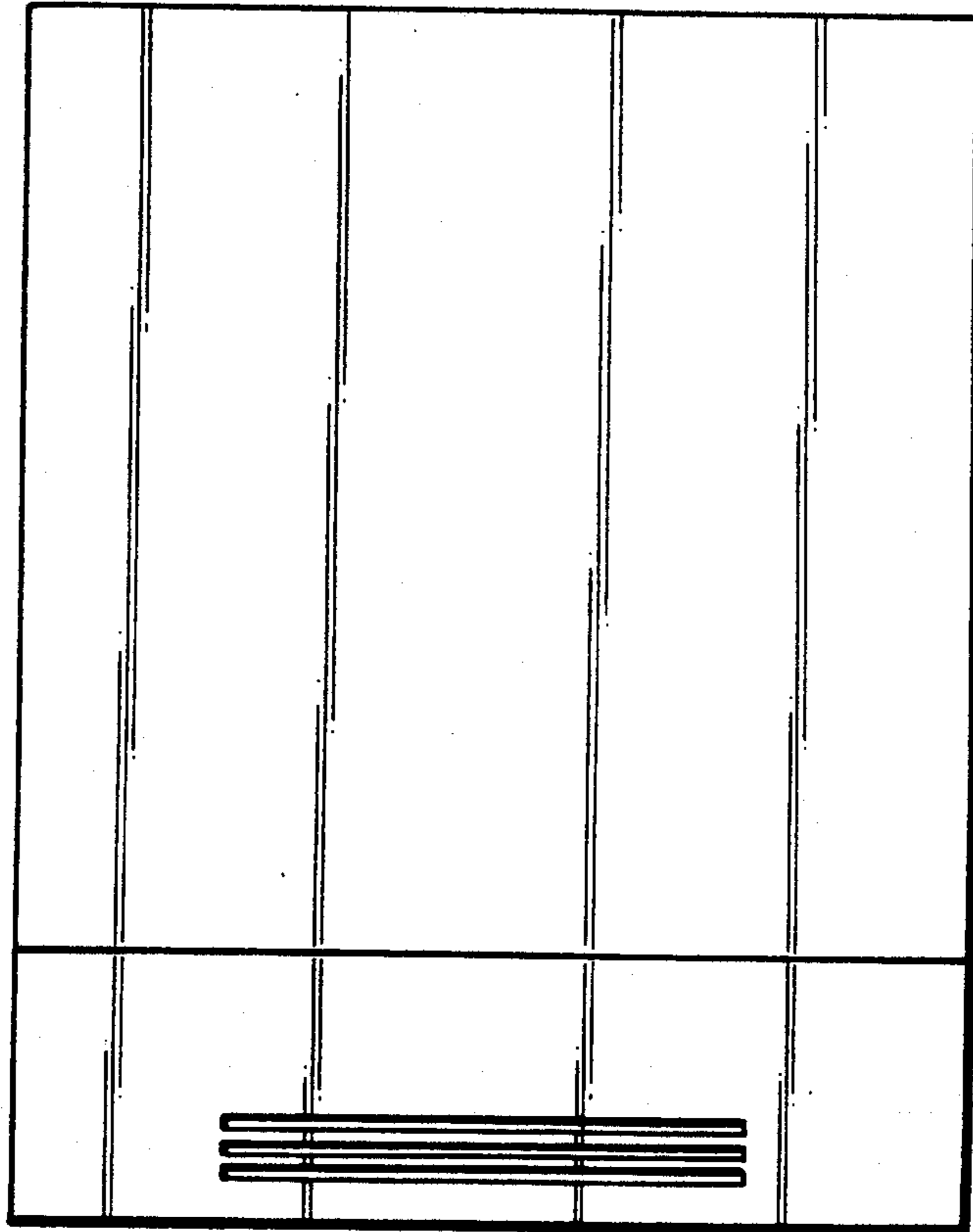

FIG.6

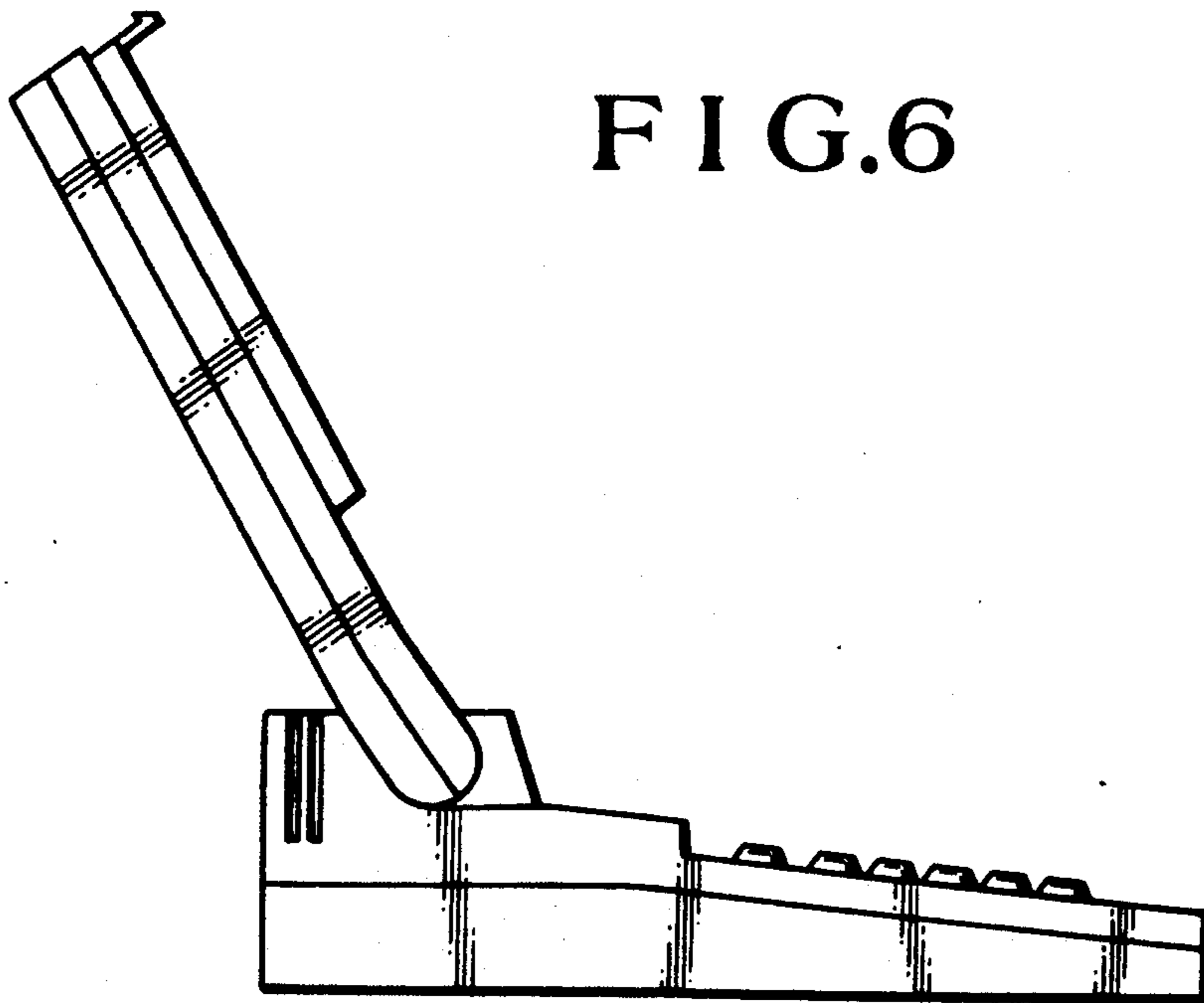

FIG.7

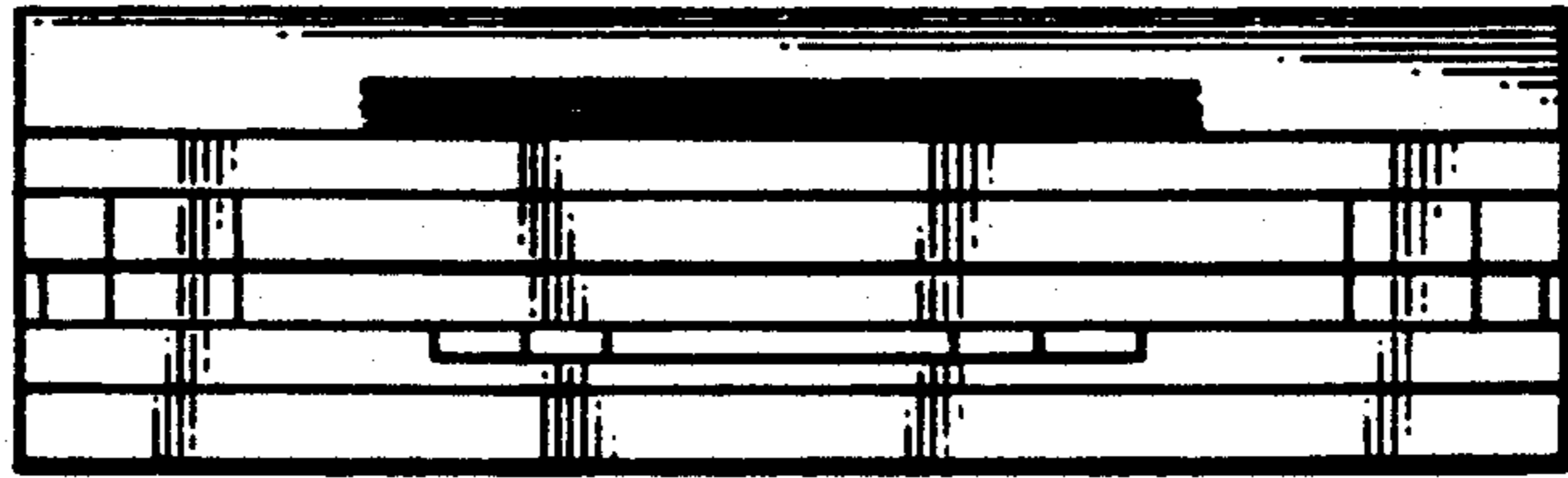

FIG.8

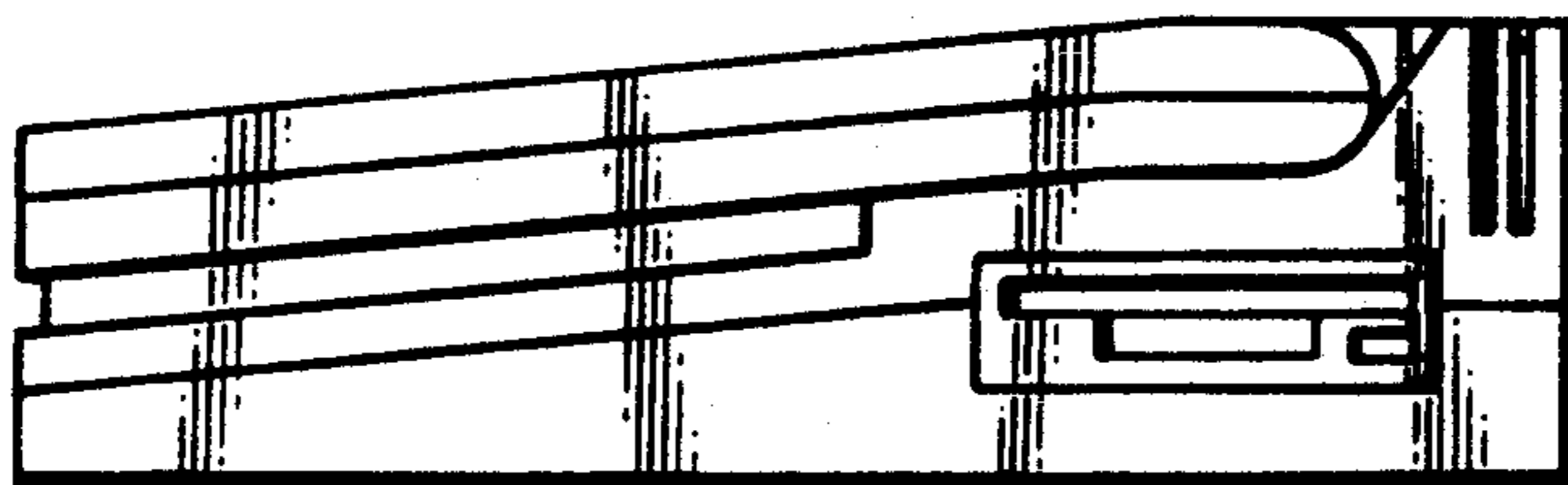

FIG.9

