



US00D337483S

# United States Patent [19]

[11] Patent Number: **Des. 337,483**

Newton et al.

[45] Date of Patent: **\*\* Jul. 20, 1993**

[54] GRID

[57] CLAIM

[75] Inventors: **Brian L. Newton, Woonsocket, R.I.;  
Takeshi Fukuda, Osaka, Japan**

The ornamental design for a grid, as shown.

### DESCRIPTION

[73] Assignee: **Dart Industries Inc., Deerfield, Ill.**

FIG. 1 is a perspective view of a grid showing our new design;

[\*\*] Term: **14 Years**

FIG. 2 is a top plan view thereof;

[21] Appl. No.: **624,917**

FIG. 3 is a bottom plan view thereof;

[22] Filed: **Dec. 6, 1990**

FIG. 4 is a front elevational view thereof;

[52] U.S. Cl. .... **D7/409; D7/388**

FIG. 5 is a rear elevational view thereof;

[58] Field of Search ..... **D7/359, 409, 388;  
126/152 R, 214 C, 332, 337 R; 211/181;  
99/425, 393**

FIG. 6 is a right side elevational view thereof;

FIG. 7 is a left side elevational view thereof;

FIG. 8 is a cross-sectional view taken along line 8—8 of FIG. 2;

FIG. 9 is a cross-sectional view taken along line 9—9 of FIG. 2.

### [56] References Cited

#### U.S. PATENT DOCUMENTS

D. 227,028	5/1973	Behm	.....	D7/359
D. 286,497	11/1986	Daenen et al.	.....	D7/388
1,732,910	10/1929	Possons	.....	99/425
2,655,283	10/1953	Mocdt	.....	99/393 X

FIG. 10 is a perspective view of a second embodiment of our new design of FIGS. 1-9;

FIG. 11 is a top plan view of FIG. 10;

FIG. 12 is a bottom plan view of FIG. 10;

FIG. 13 is a front elevational view of FIG. 10;

FIG. 14 is a rear elevational view of FIG. 10;

FIG. 15 is a right side elevational view of FIG. 10;

FIG. 16 is a left side elevational view of FIG. 10;

FIG. 17 is a cross-sectional view taken along line 17—17 of FIG. 11; and,

FIG. 18 is a cross-sectional view taken along line 18—18 of FIG. 11.

*Primary Examiner*—Alan P. Douglas  
*Assistant Examiner*—Caron D. Veynar  
*Attorney, Agent, or Firm*—John A. Doninger

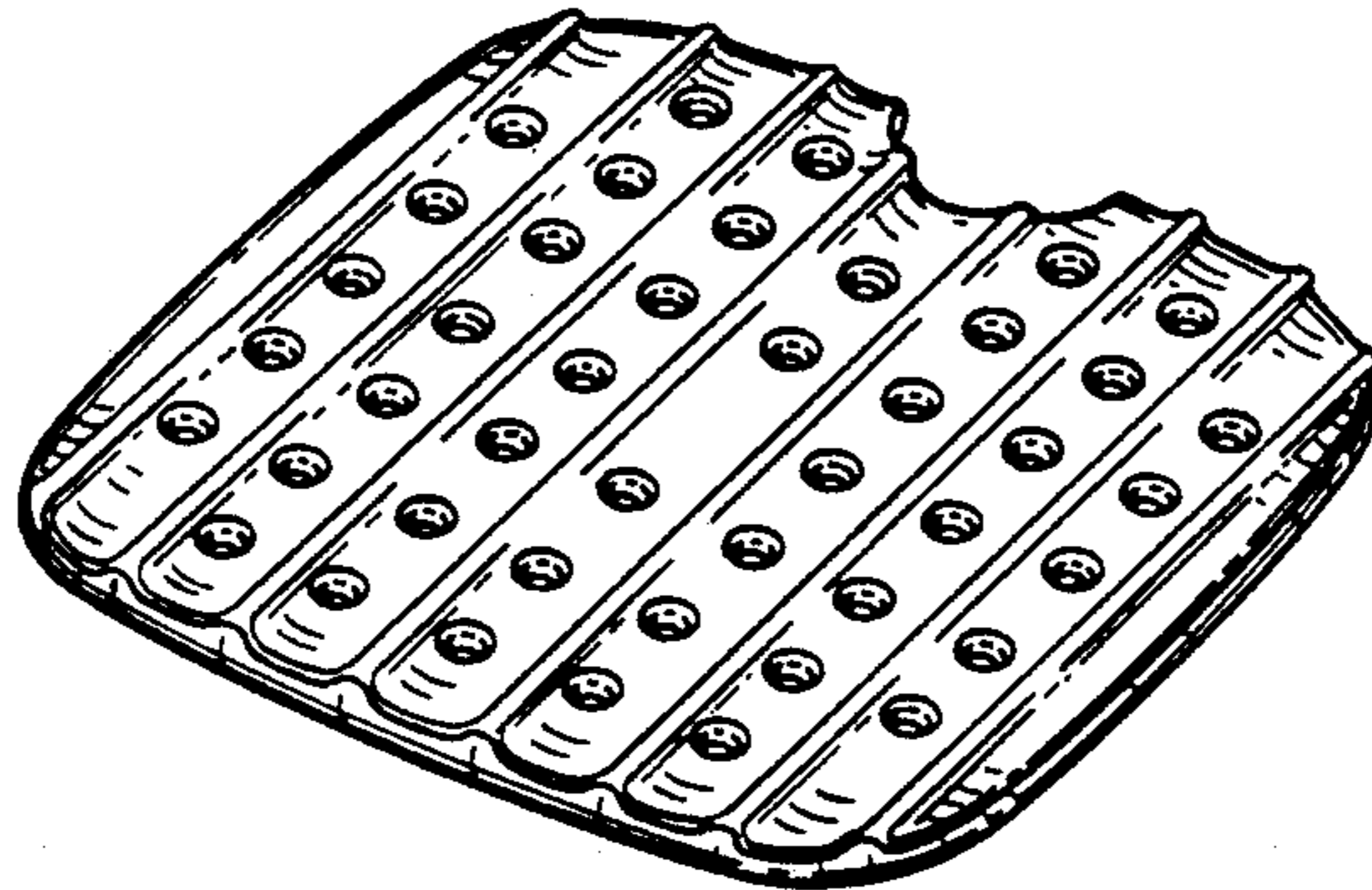
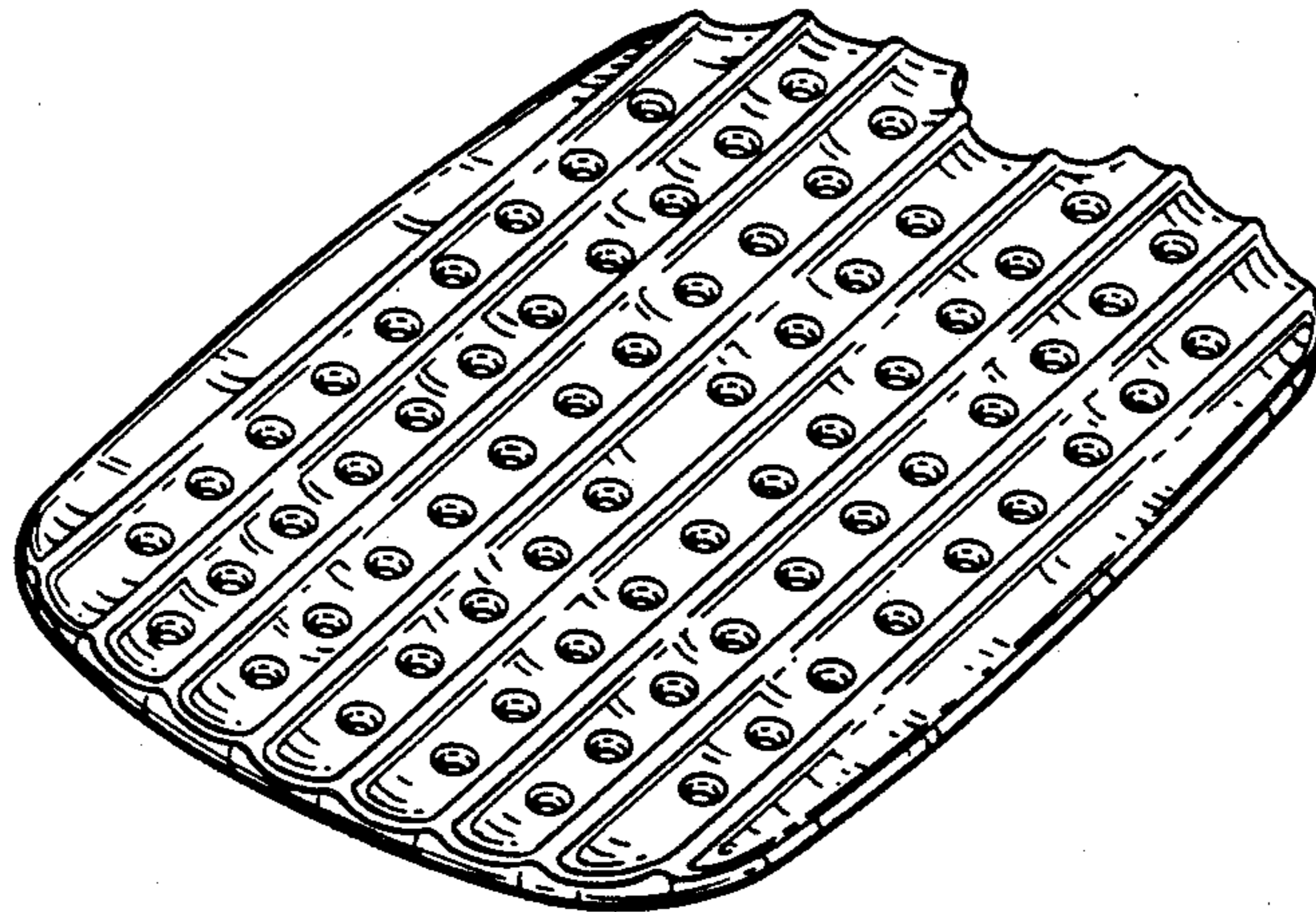

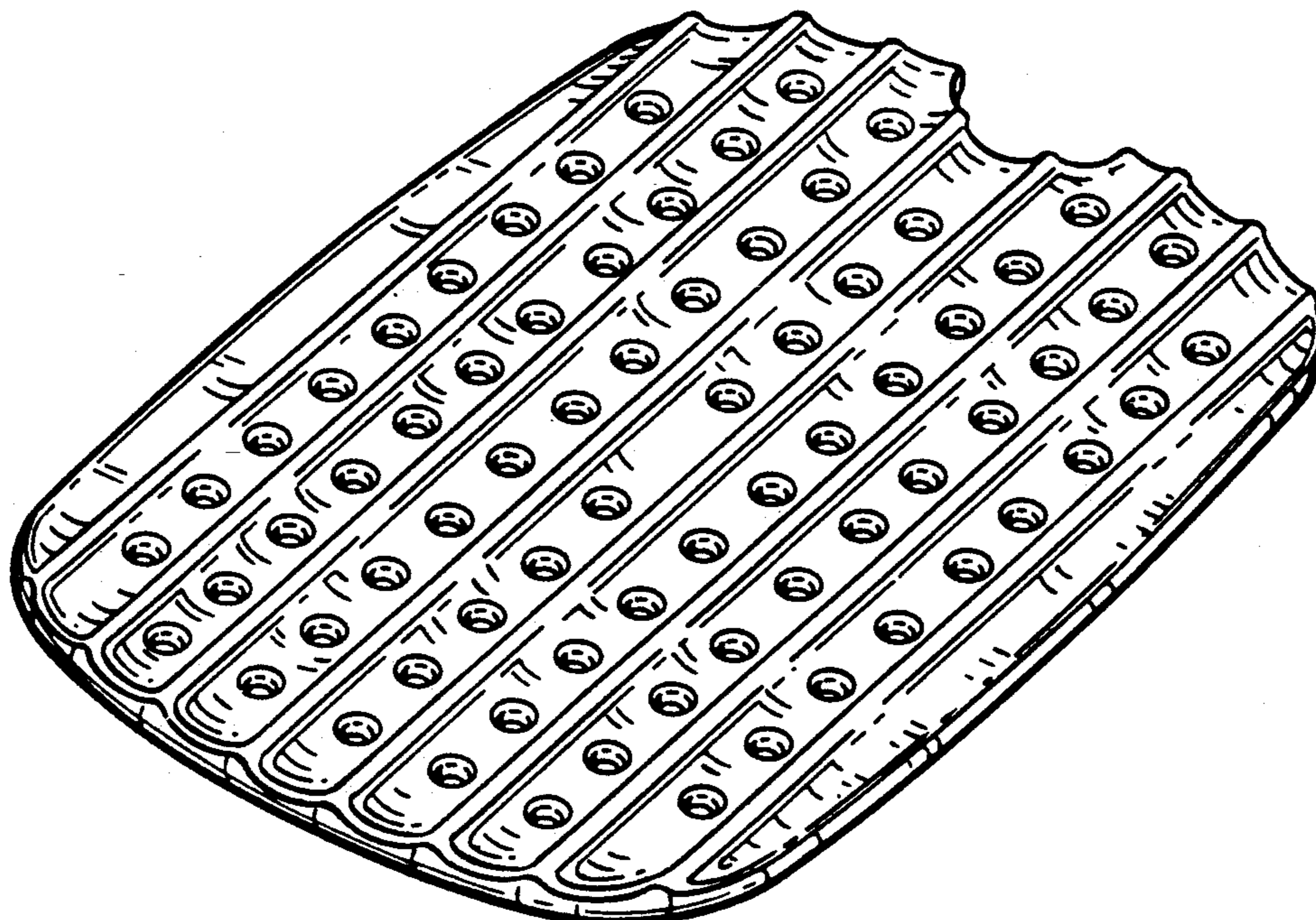

FIG. 1

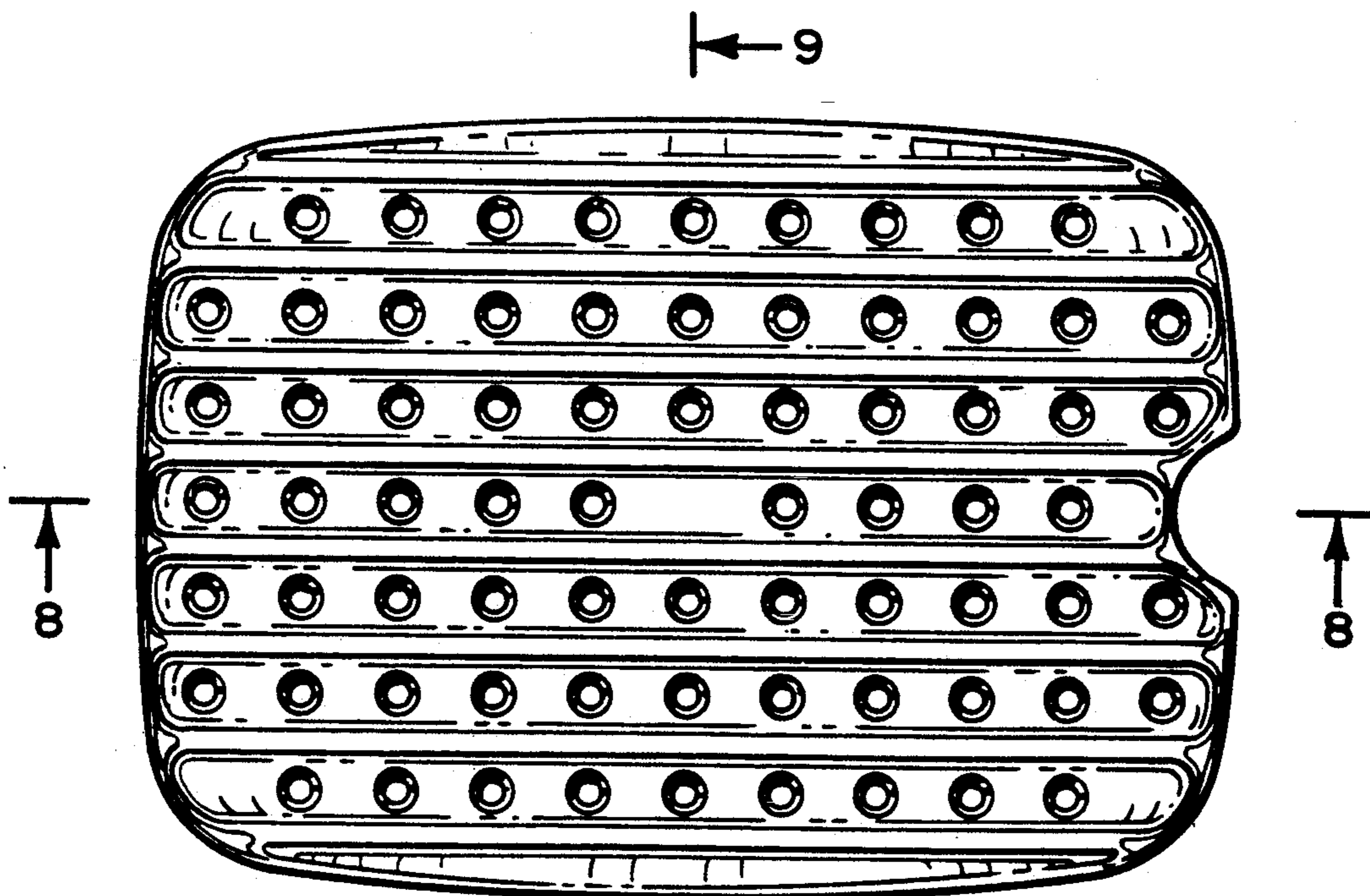

FIG. 2

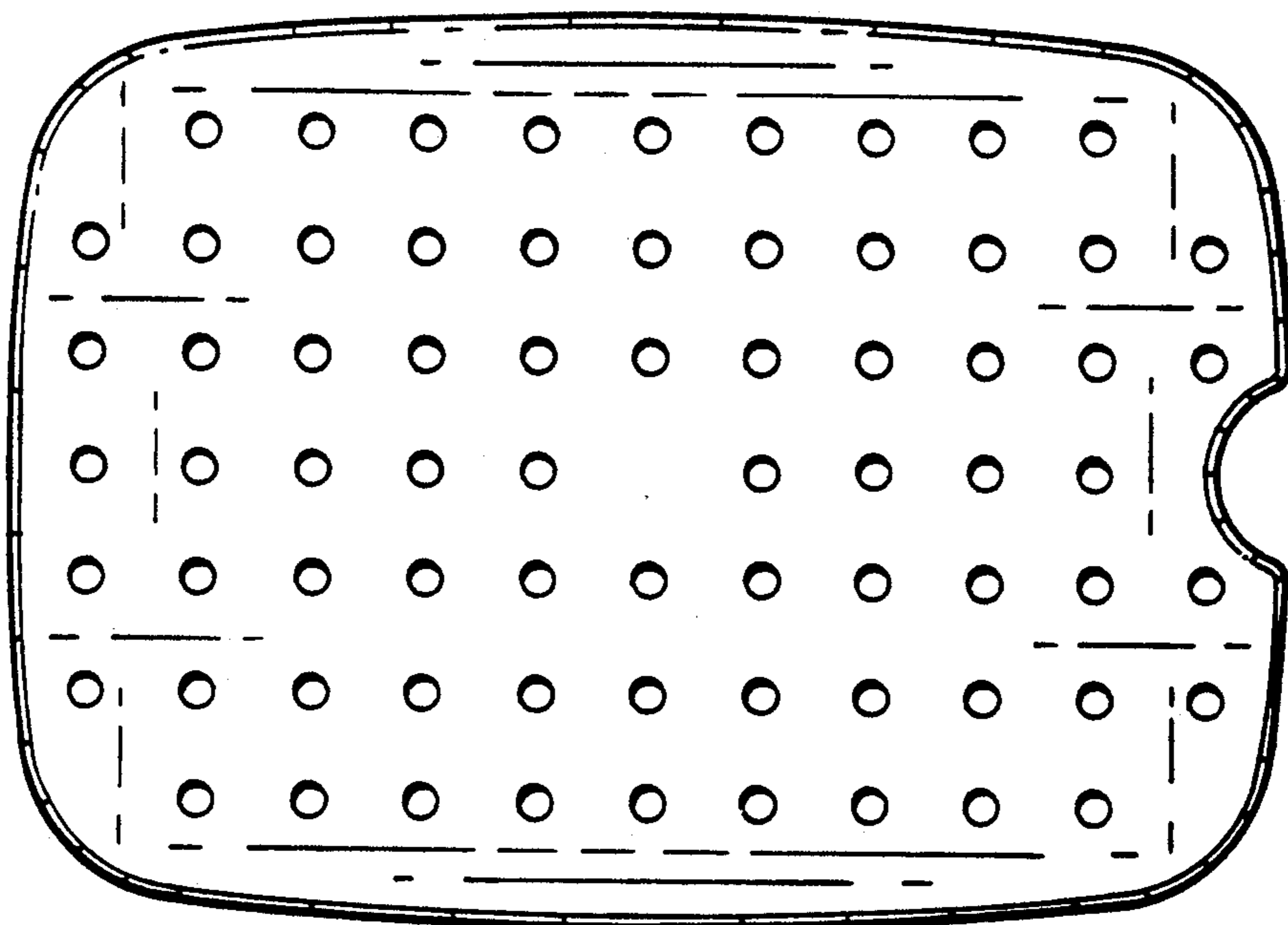

FIG. 3



FIG. 4



FIG. 5

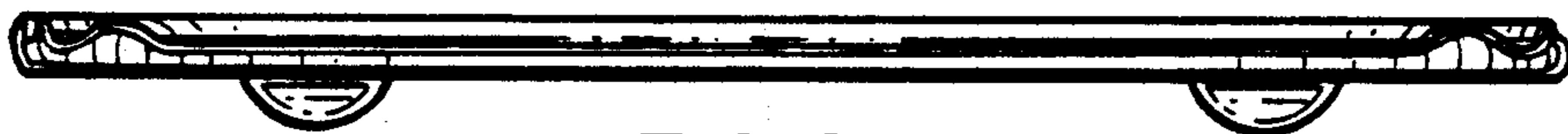

FIG. 6

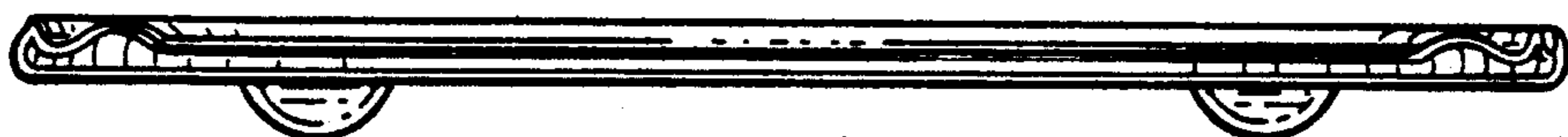

FIG. 7



FIG. 8



FIG. 9

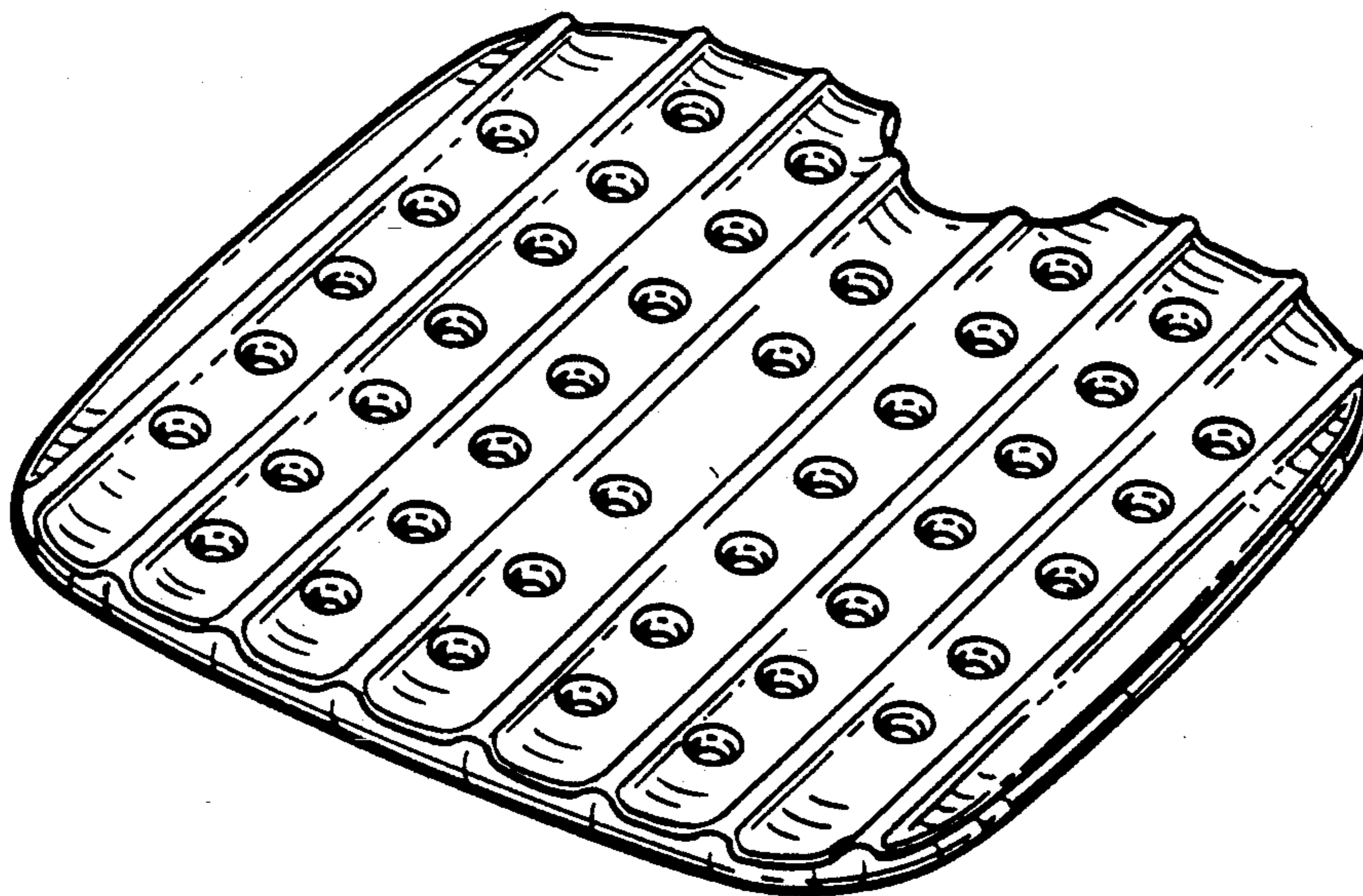

FIG. 10

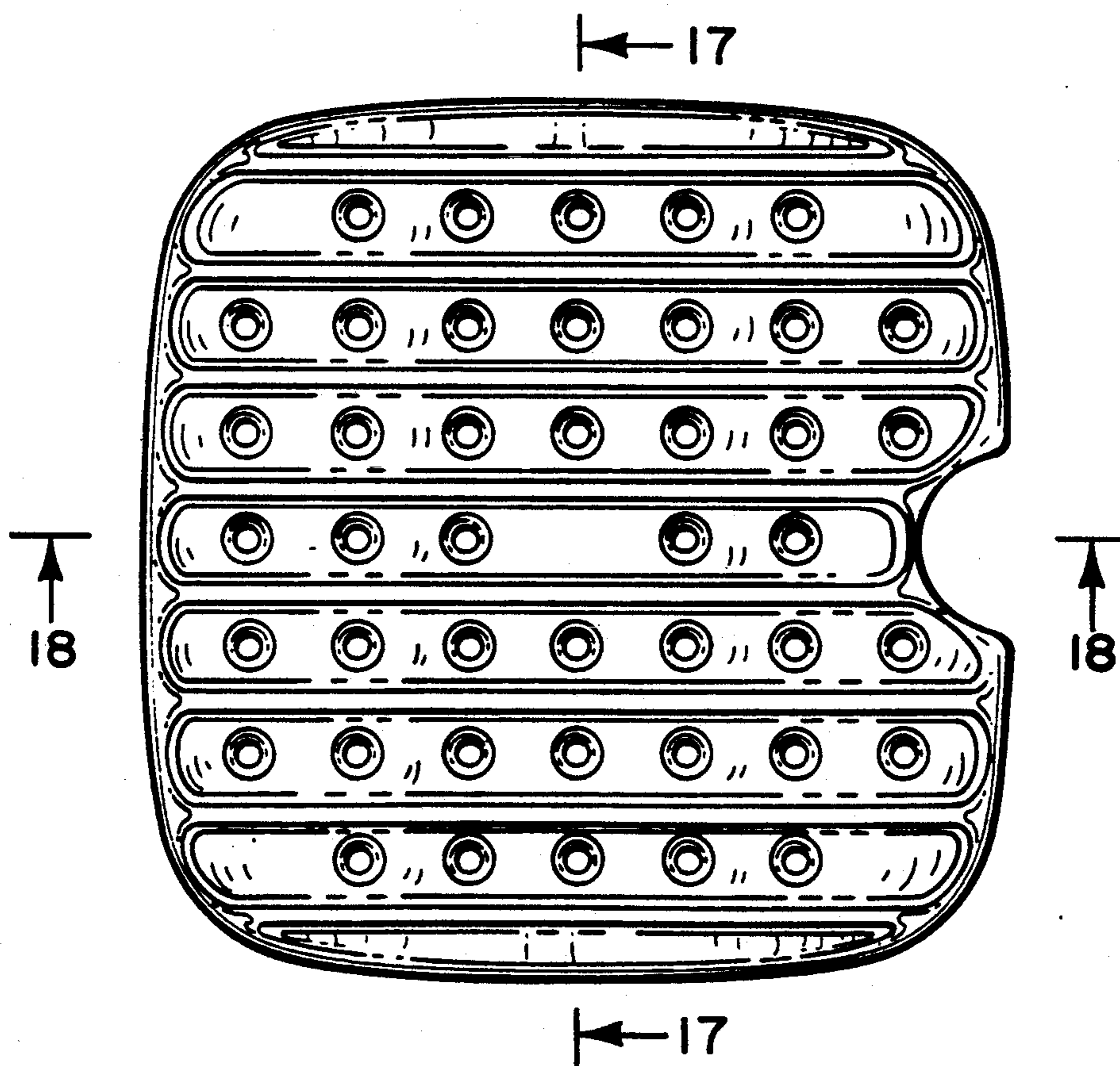

FIG. 11

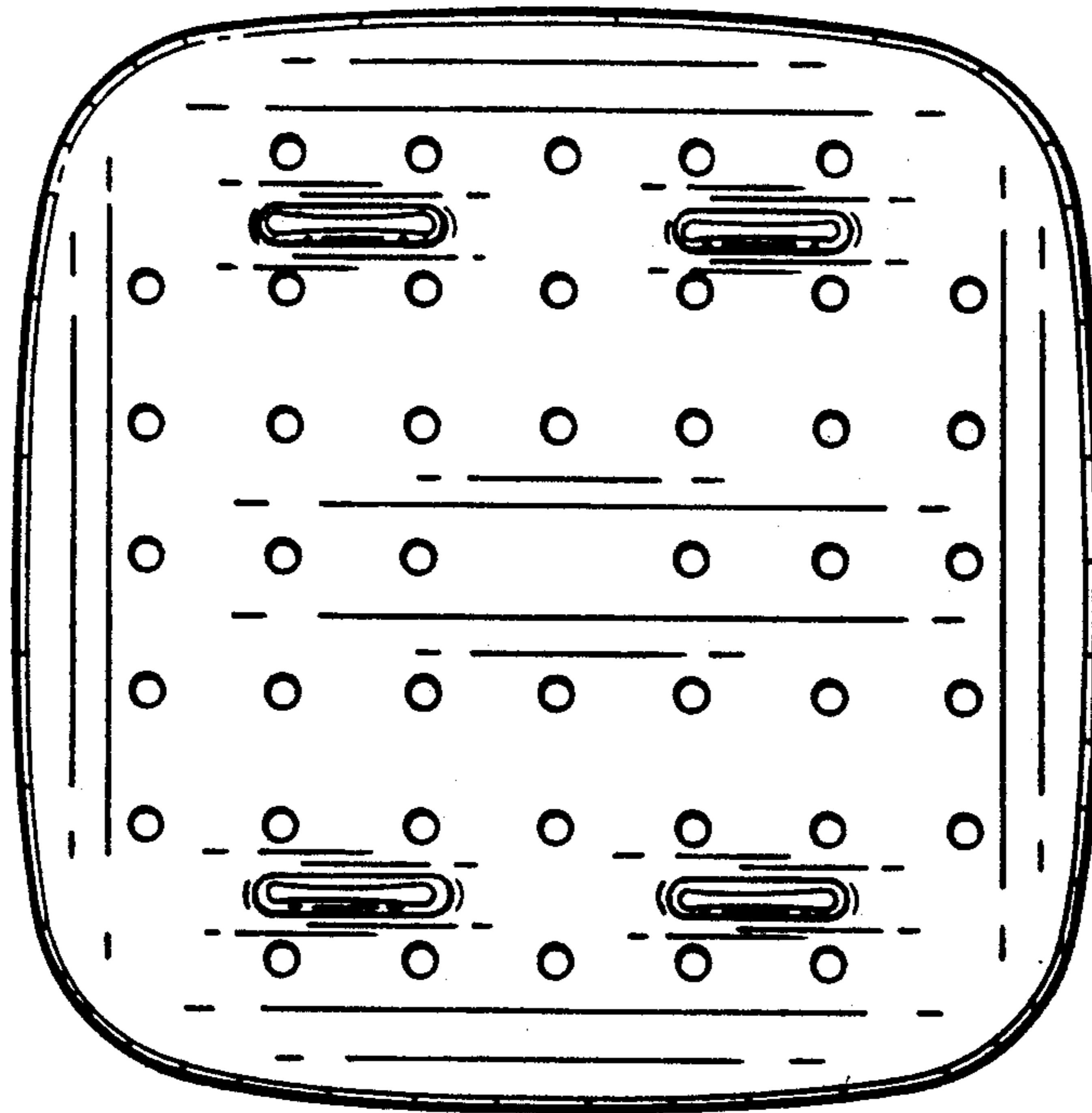

FIG. 12



FIG. 13



FIG. 14

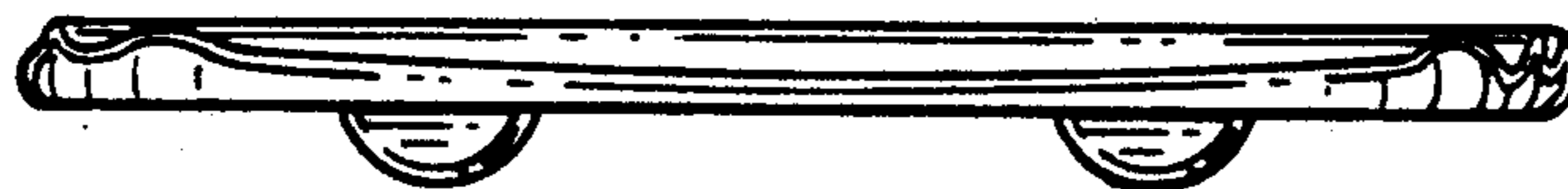

FIG. 15

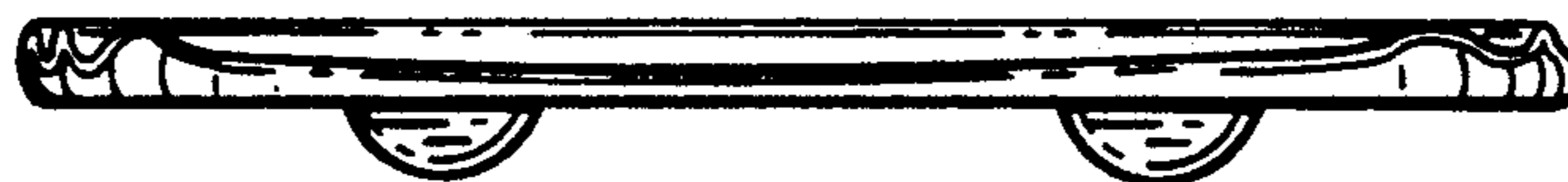

FIG. 16



FIG. 17



FIG. 18