



US00D337436S

United States Patent [19]

[11] Patent Number: **Des. 337,436**

Hopkins

[45] Date of Patent: **** Jul. 20, 1993**

[54] **SNOW BRUSH WITH REMOVABLE SCRAPER**

2,792,584	5/1957	Fryda	15/236
3,017,649	1/1962	Racicot	15/105
3,051,975	9/1962	Schwartz	15/105
4,041,564	8/1977	Schlicher	15/111
4,719,660	1/1988	Hopkins	15/105

[75] Inventor: **Kenneth L. Hopkins, Emporia, Kans.**

[73] Assignee: **Hopkins Manufacturing Corporation, Emporia, Kans.**

[**] Term: **14 Years**

Primary Examiner—Wallace R. Burke
Assistant Examiner—Lavone D. Tabor
Attorney, Agent, or Firm—Calfee, Halter & Griswold

[21] Appl. No.: **574,928**

[57] **CLAIM**

[22] Filed: **Aug. 30, 1990**

The ornamental design for a snow brush with removable scraper, as shown and described.

[52] U.S. Cl. **D4/118; D32/42; D32/48**

DESCRIPTION

[58] Field of Search **D4/116, 118, 121, 130, D4/134, 138, 199; D32/40, 42, 46, 48, 49; 15/105-106, 111, 144 R, 143 R, 159 R, 159 A, 160, 236.01, 236.02, 236.08, 236.09; 30/169**

FIG. 1 is a top plan view of a snow brush with removable scraper showing my new design;
FIG. 2 is a bottom plan view thereof;
FIG. 3 is a side elevational view thereof, the opposite side being a mirror image;
FIG. 4 is a front end elevational view thereof;
FIG. 5 is a rear end elevational view thereof;
FIG. 6 is an exploded side elevational view thereof, shown with the scraper removed;
FIG. 7 is a bottom plan view of the scraper shown separately for clarity of illustration only;
FIG. 8 is a top perspective view of the snow brush with removable scraper of **FIG. 1**; and,
FIG. 9 is a bottom perspective view of the snow brush with removable scraper as shown in **FIG. 1**.

[56] **References Cited**

U.S. PATENT DOCUMENTS

146,713	1/1874	Ryan	15/145
D. 258,779	4/1981	Hopkins et al.	D4/118
D. 265,269	7/1982	Frantz	D4/118
D. 267,291	12/1982	Hopkins et al.	D4/134
D. 269,054	5/1983	Bauer	D4/118
D. 327,368	6/1992	Zierhut	D4/121
511,769	1/1894	Gladding	15/145
1,887,913	11/1932	Bell	15/145 X
2,719,995	10/1955	Hohenstein	15/105

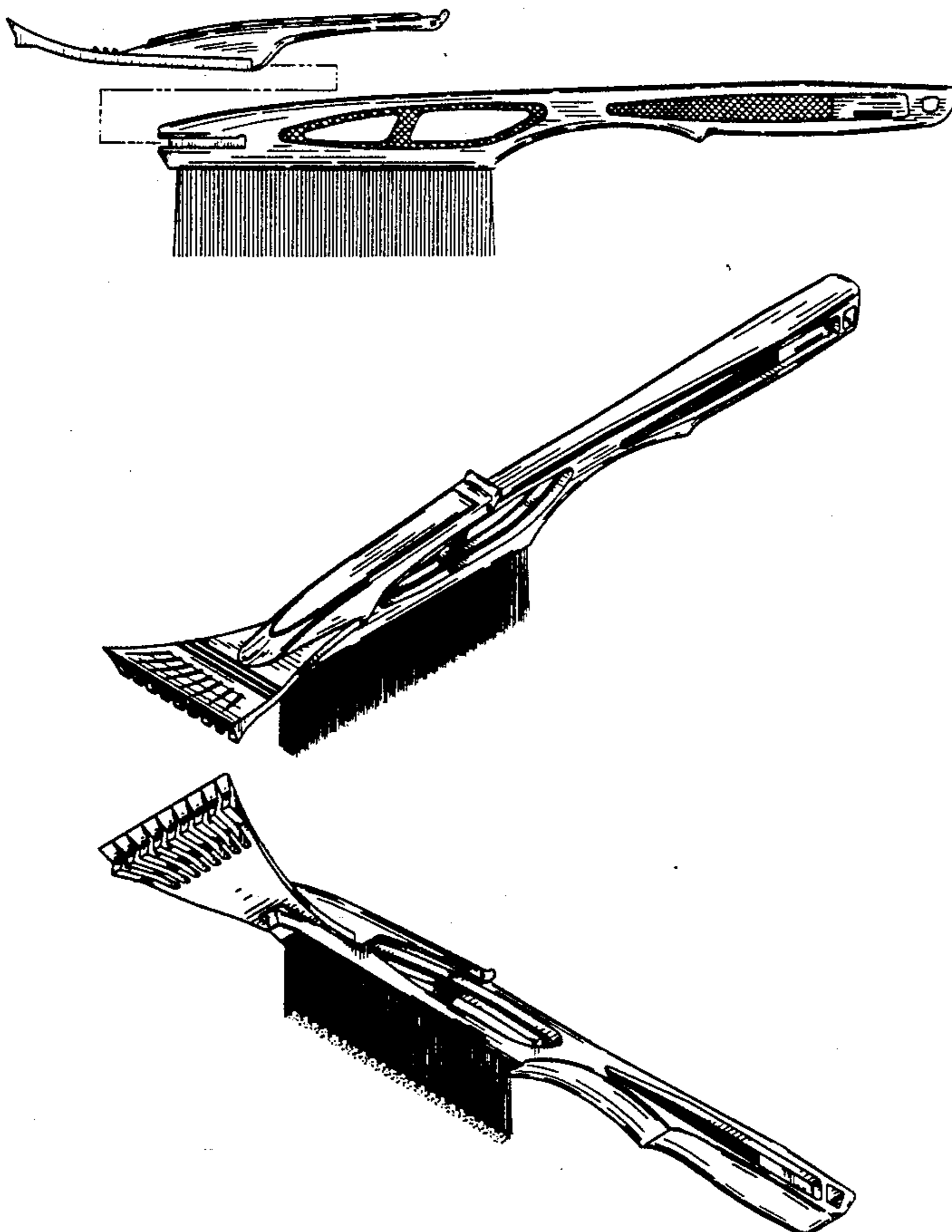

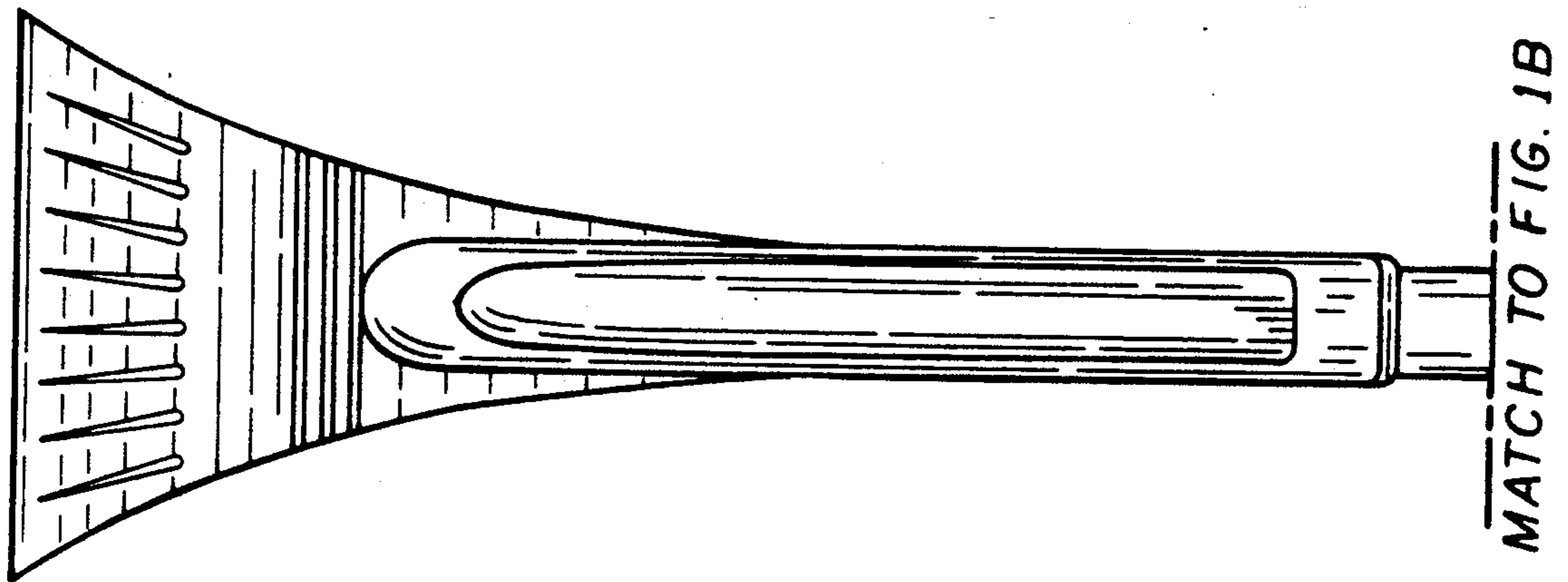

FIG. 1A

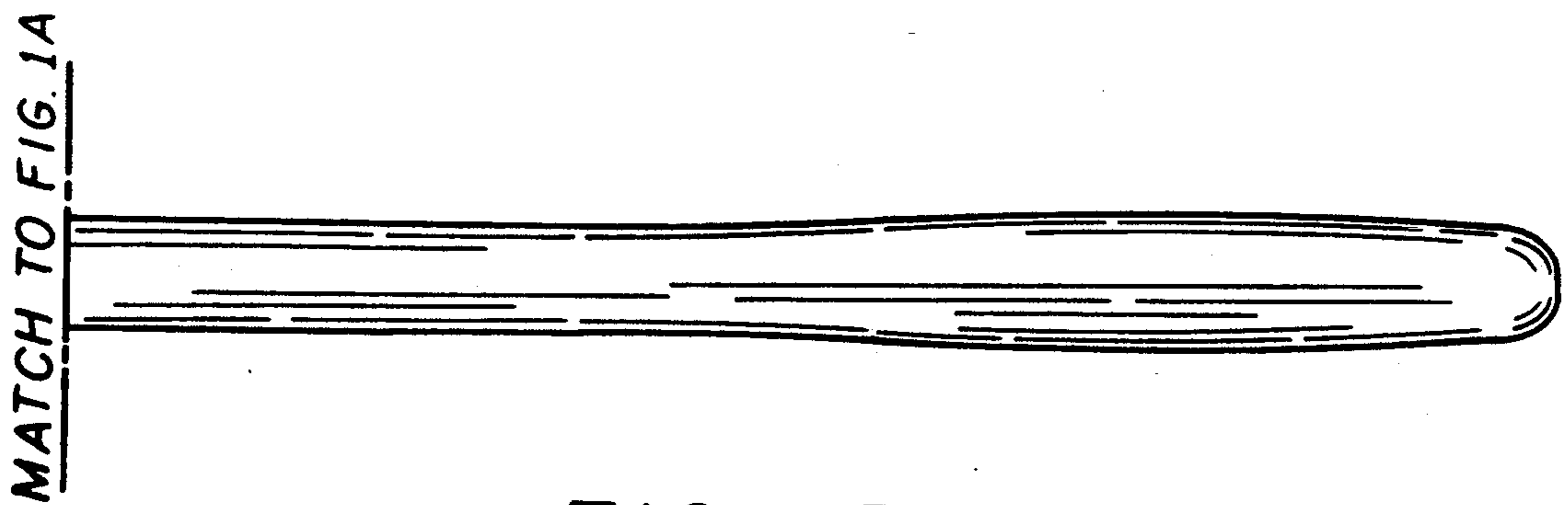

FIG. 1B

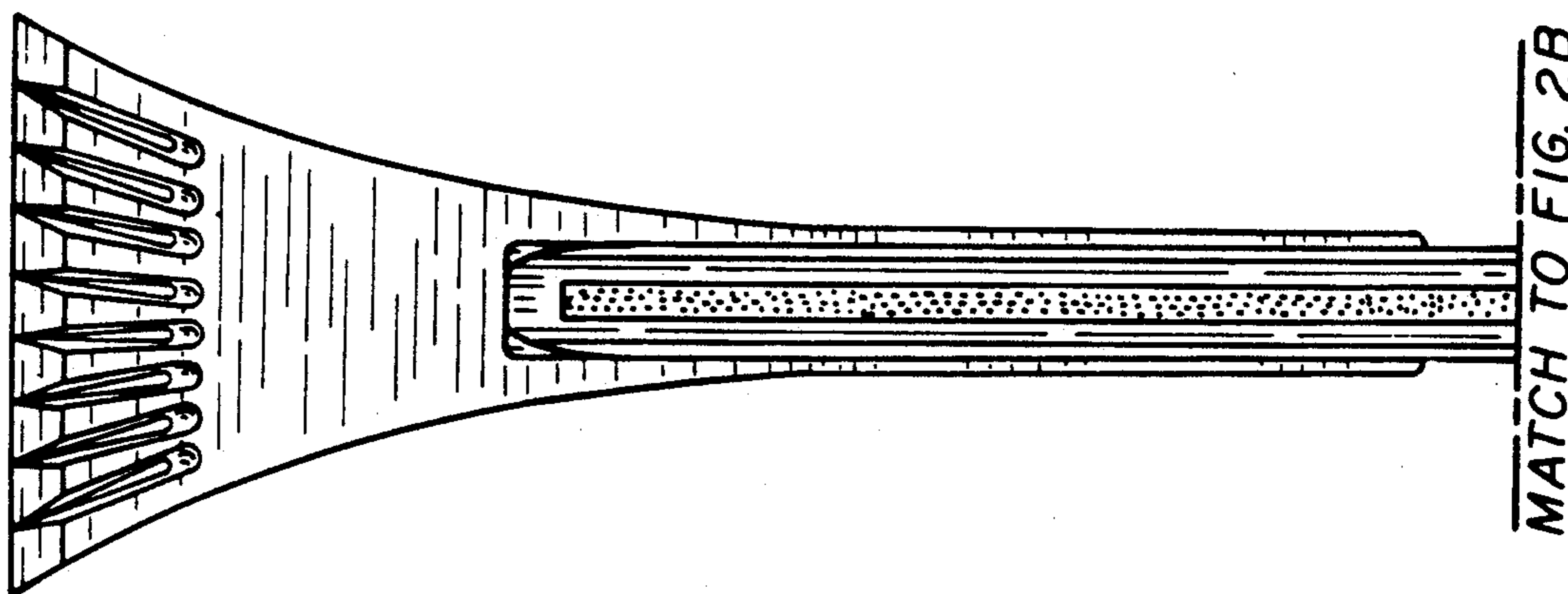

FIG. 2A

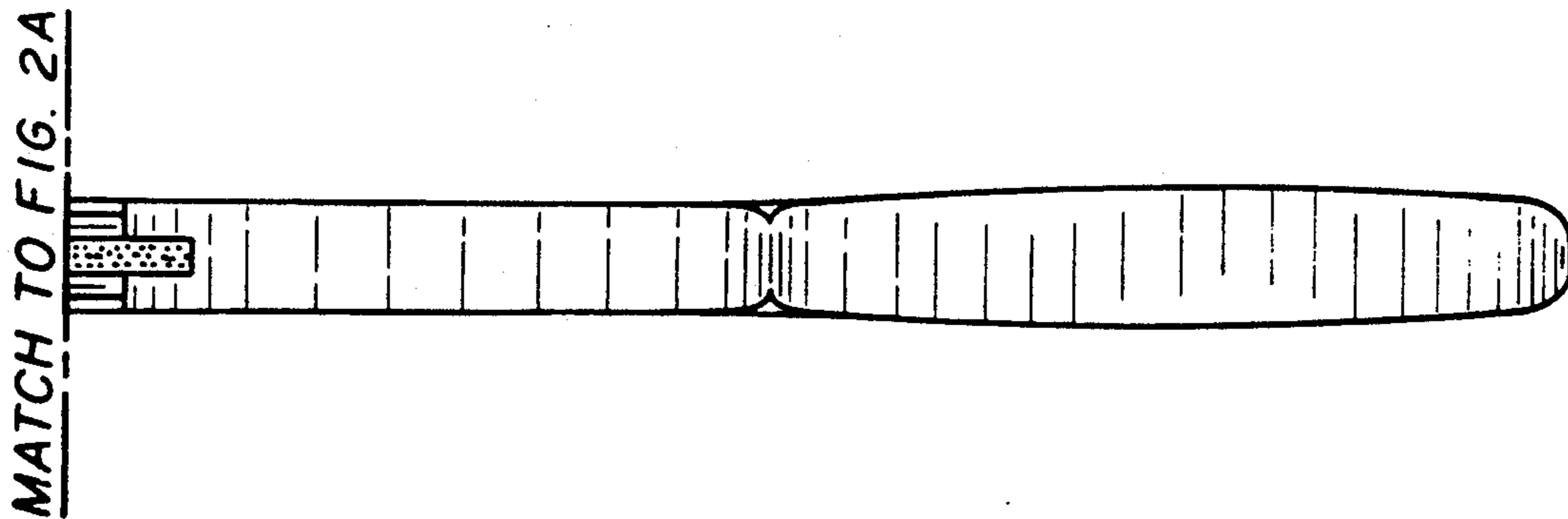

FIG. 2B

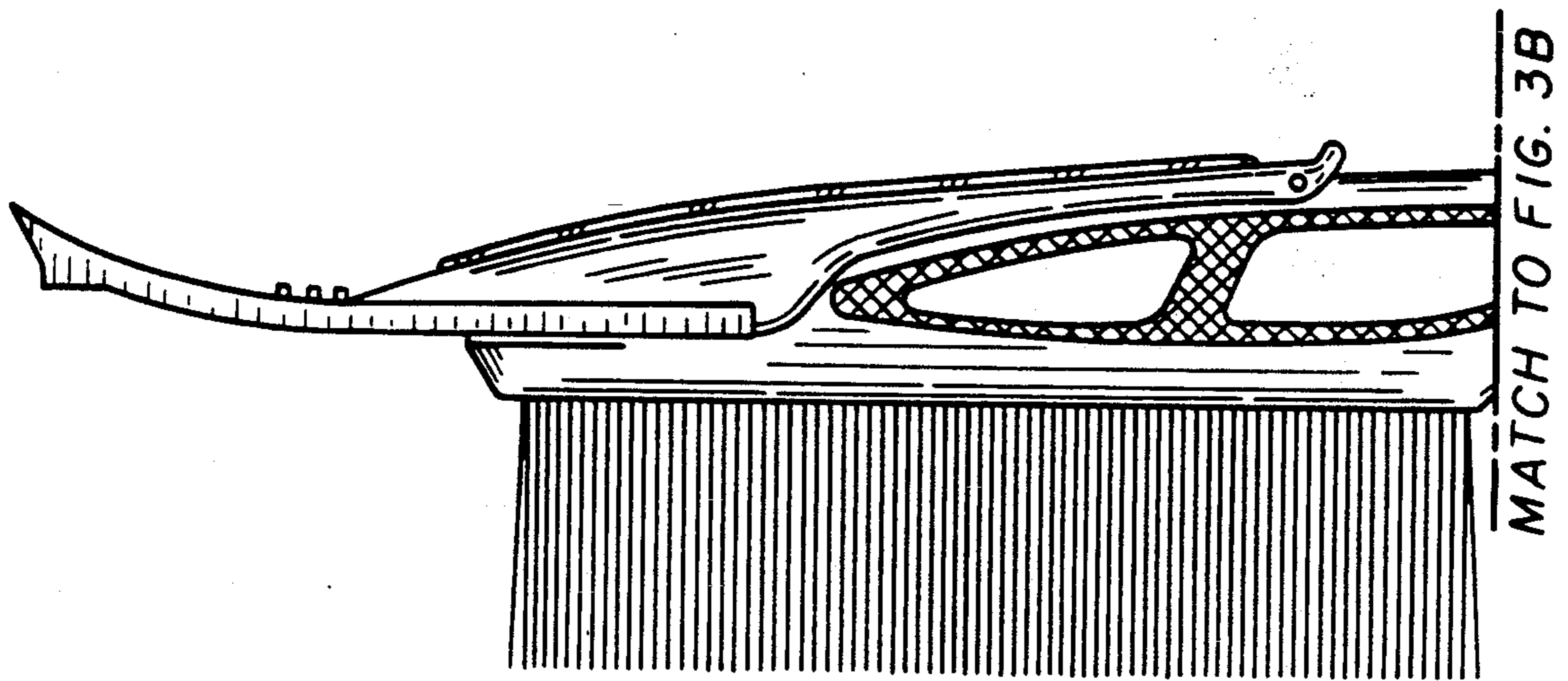

FIG. 3A

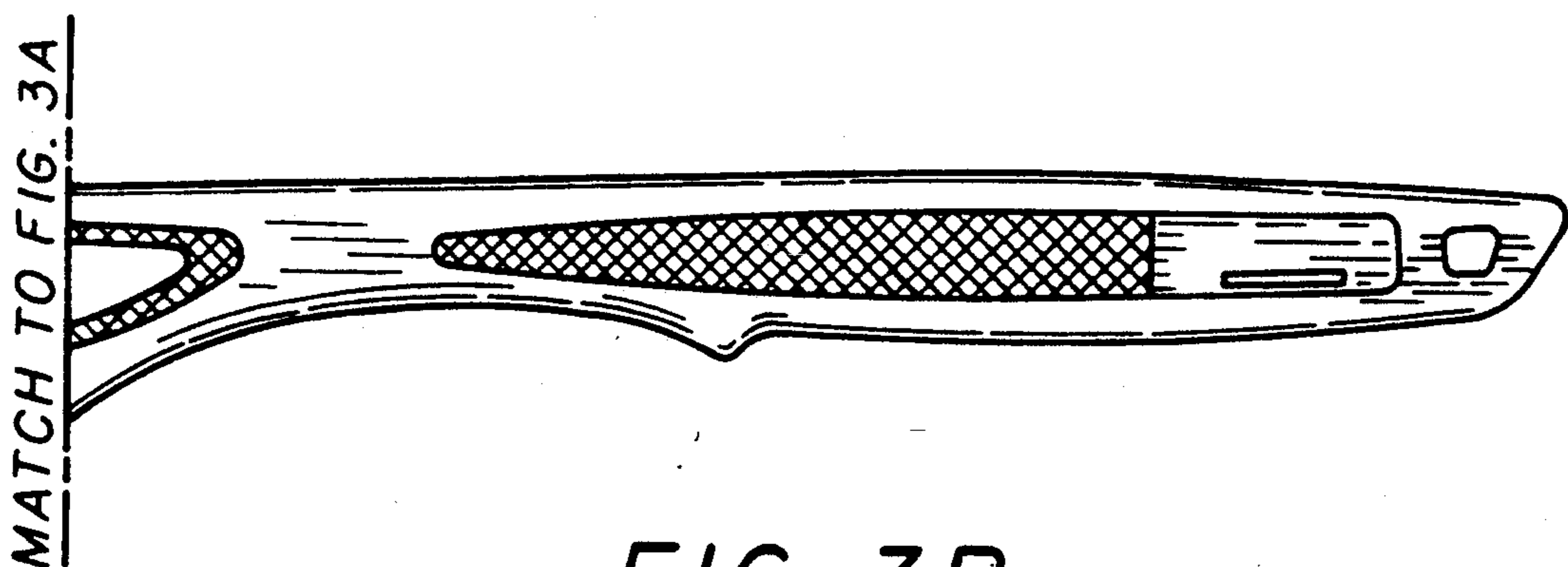

FIG. 3B

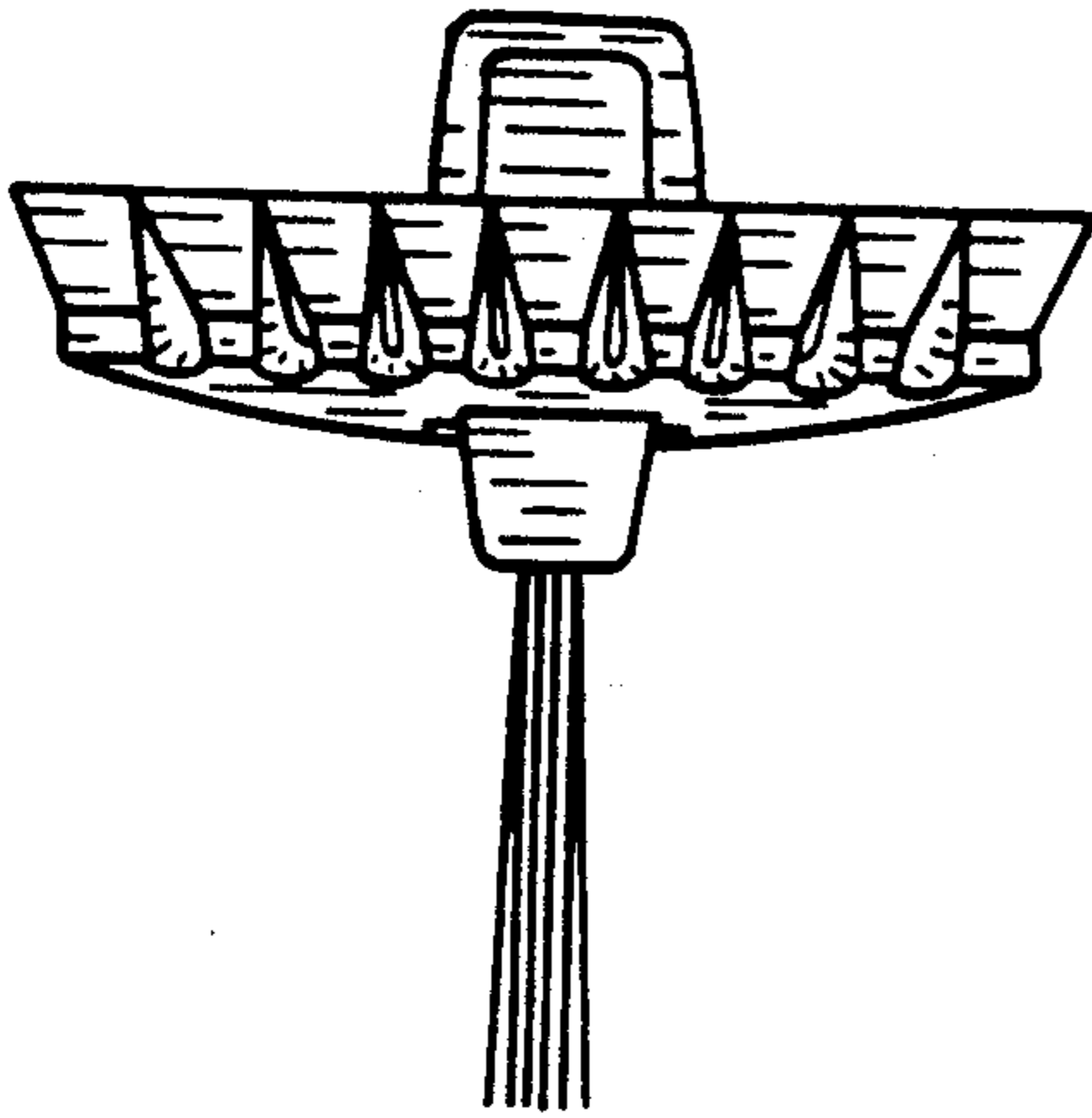

FIG. 4

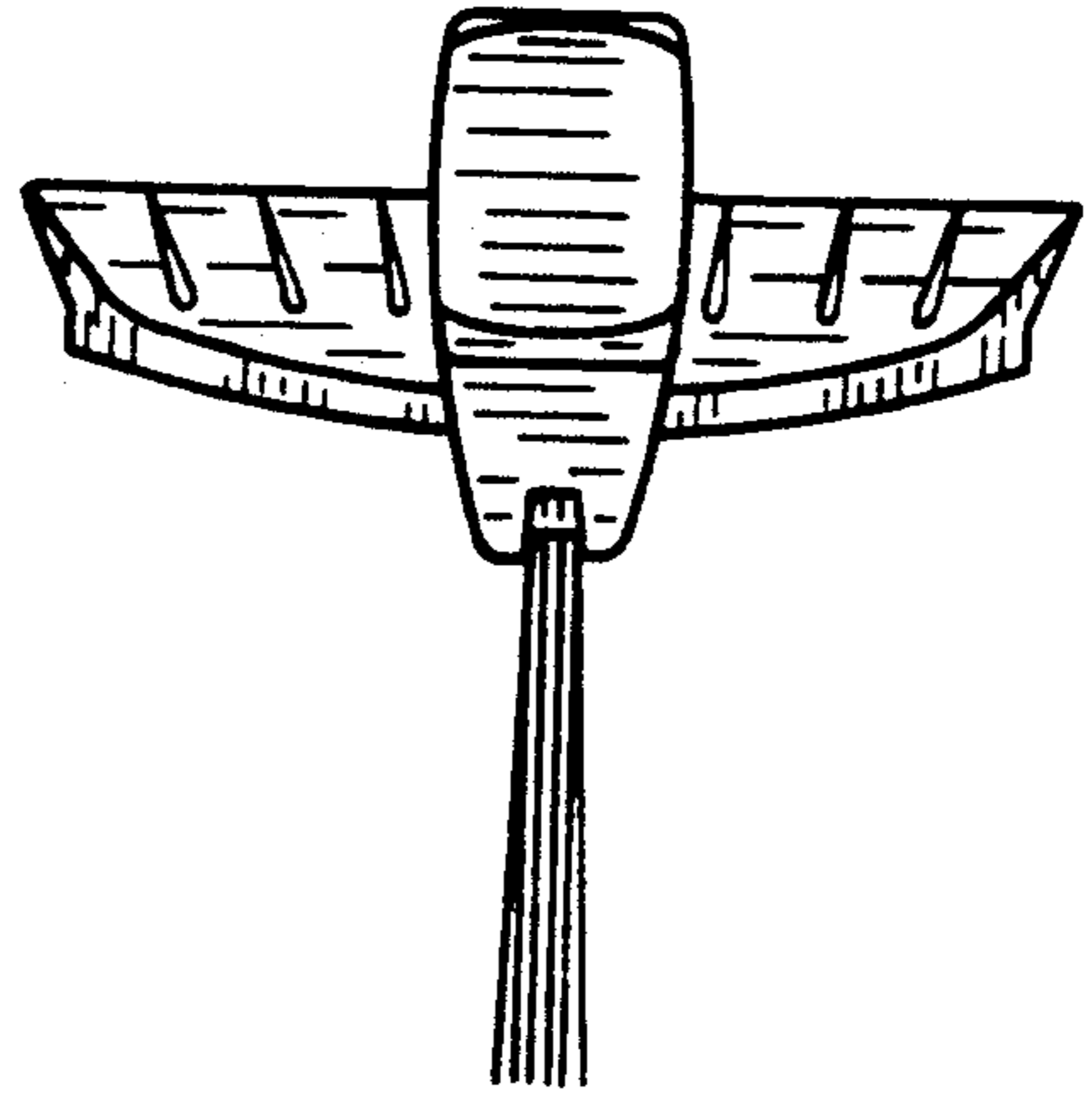

FIG. 5

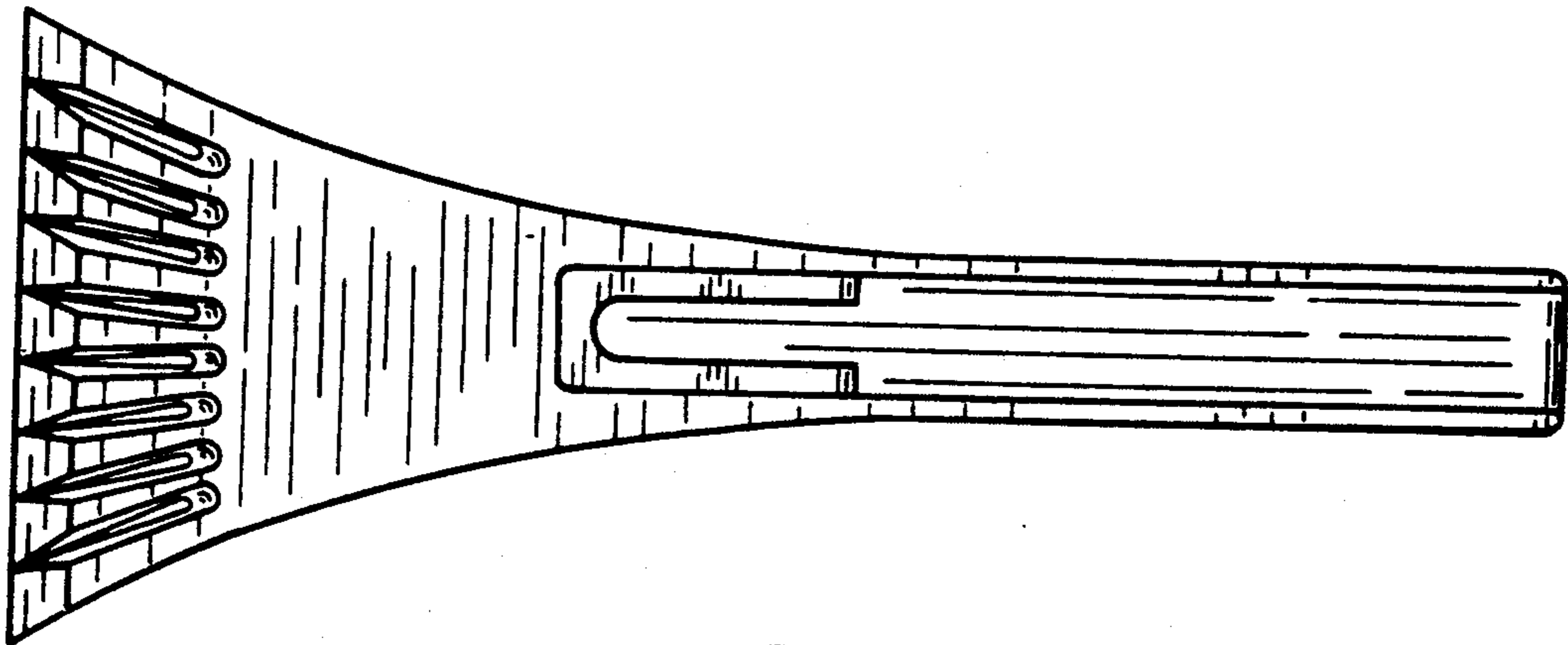

FIG. 7

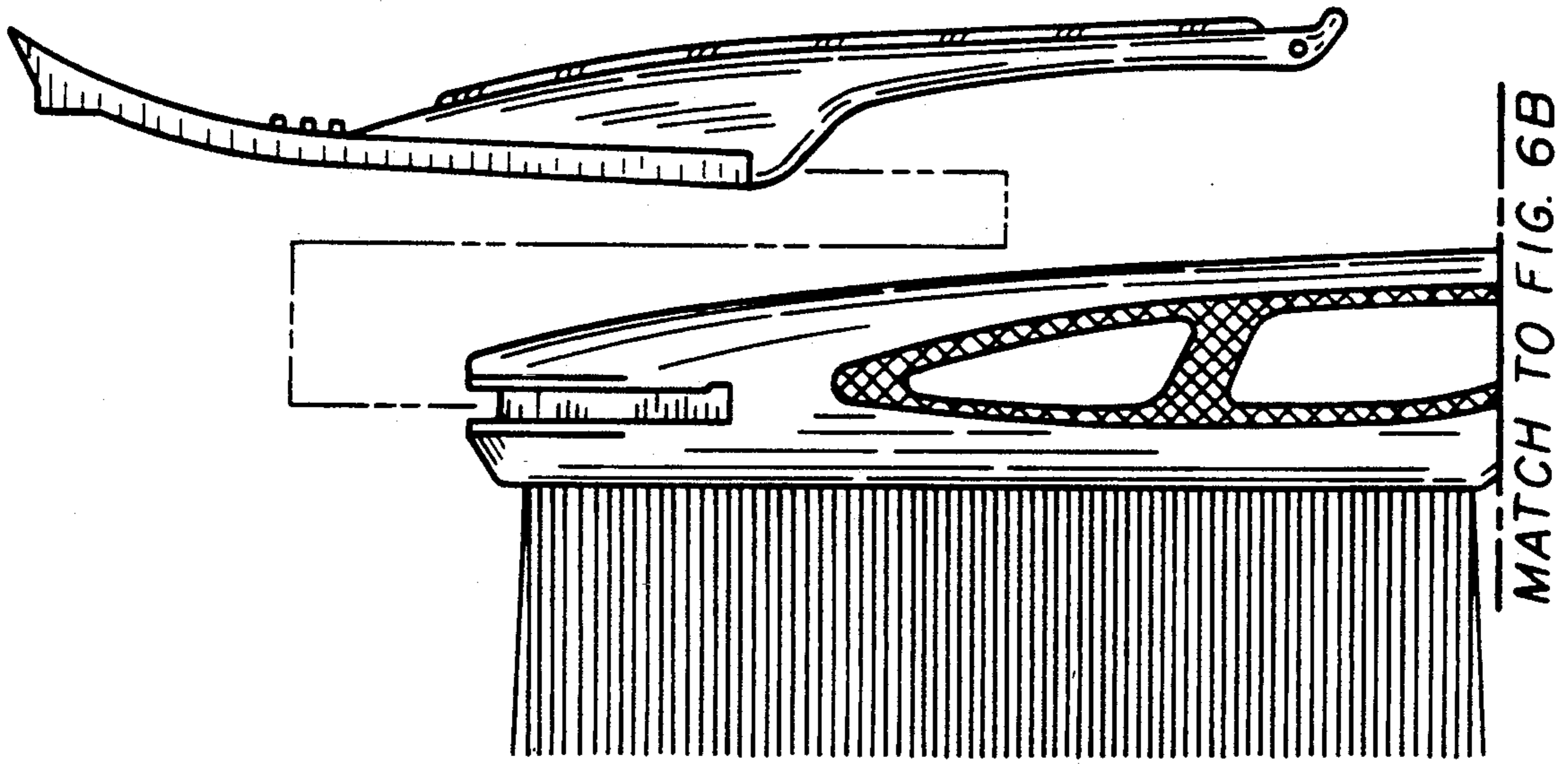

FIG. 6A

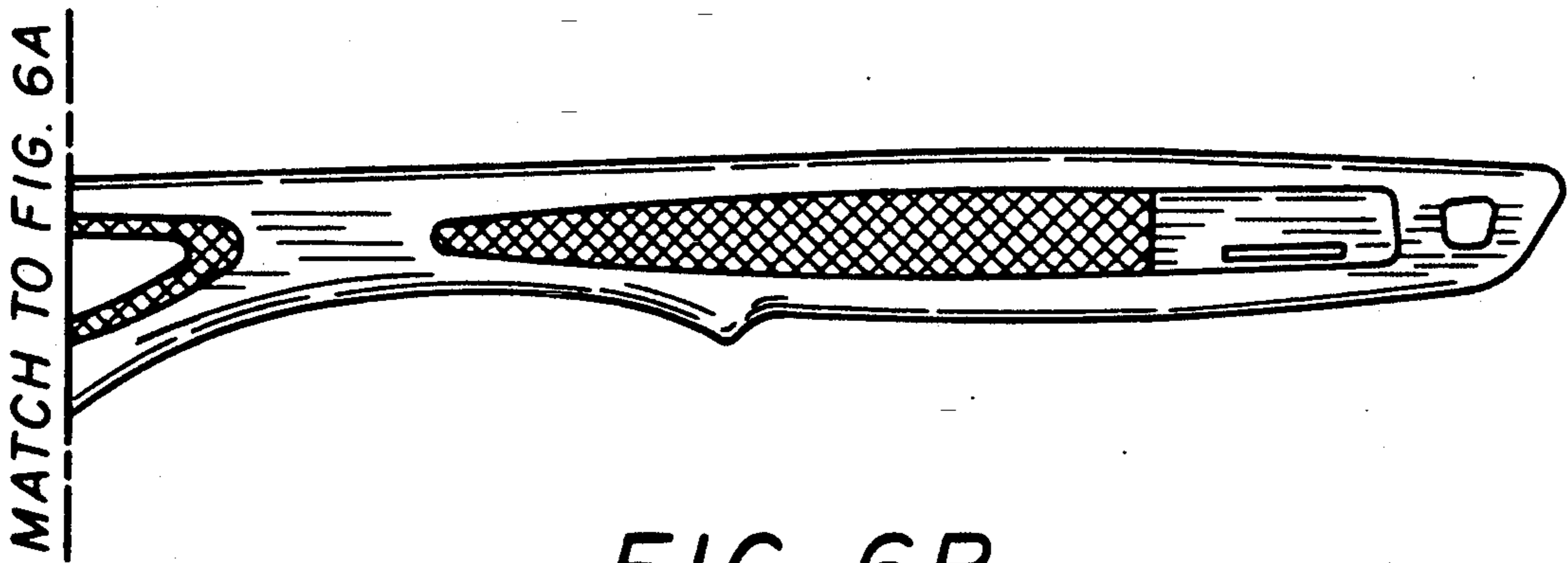

FIG. 6B

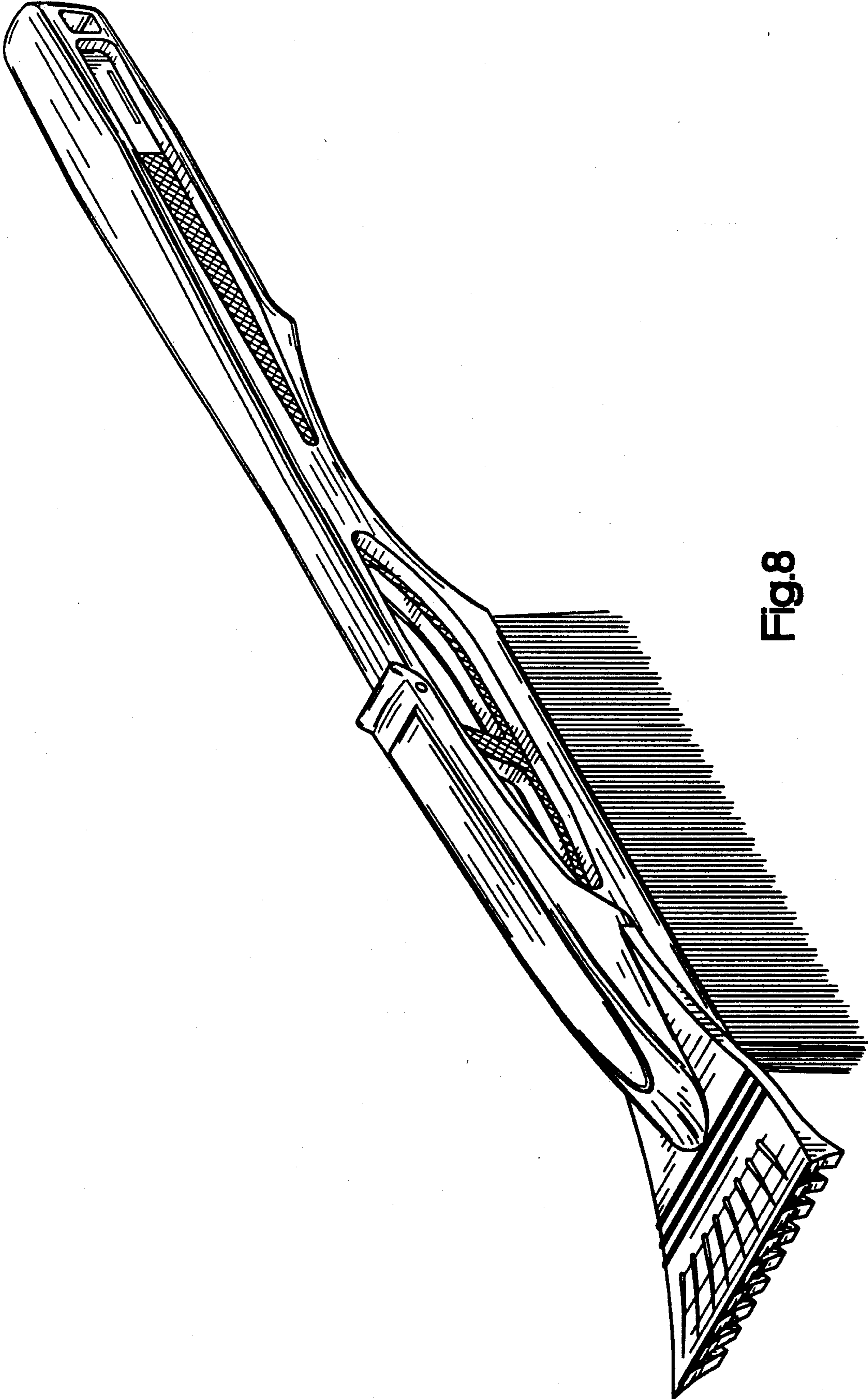

Fig.8

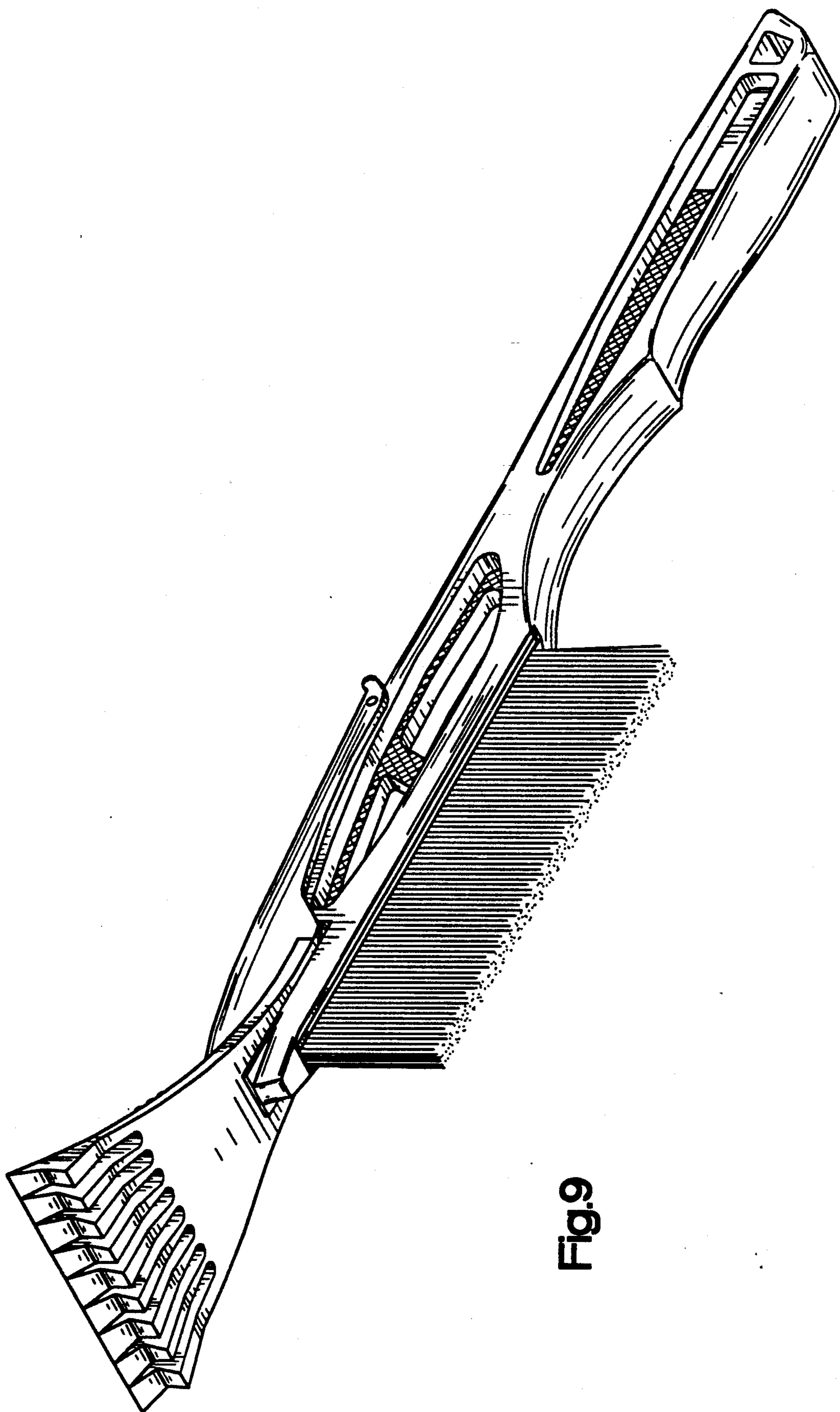

Fig. 9