



US00D337412S

United States Patent [19]

[11] Patent Number: **Des. 337,412**

Ruggles

[45] Date of Patent: **** Jul. 13, 1993**

[54] **JACK ATTACHMENT FOR PULLING A T-POST PULLER**

[76] Inventor: **Raymond L. Ruggles**, 295 Dalles Ln., Laramie, Wyo. 82070

[**] Term: **14 Years**

[21] Appl. No.: **683,668**

[22] Filed: **Apr. 11, 1991**

[52] U.S. Cl. **D34/35; D8/14**

[58] Field of Search **D34/31, 35; 254/30; D8/14.1, 14; 248/220.1**

[56] **References Cited**

U.S. PATENT DOCUMENTS

- D. 312,196 11/1990 Norma D8/14
- 4,738,433 4/1988 Hoff .
- 4,792,120 12/1988 Egaas .
- 4,846,445 7/1989 Pfeffer .

Primary Examiner—Wallace R. Burke
Assistant Examiner—H. Baynham
Attorney, Agent, or Firm—Terry M. Gernstein

[57] **CLAIM**

The ornamental design for a jack attachment for pulling a t-post, as shown and described.

DESCRIPTION

FIG. 1 is a perspective view of the jack attachment for pulling a T-post embodying the design of the present invention;

FIG. 2 is a front elevational view thereof;

FIG. 3 is a rear elevational view thereof;

FIG. 4 is a side elevational view thereof, the side opposite being a mirror image of the side shown in FIG. 4;

FIG. 5 is a top plan view thereof; and,

FIG. 6 is a bottom view thereof.

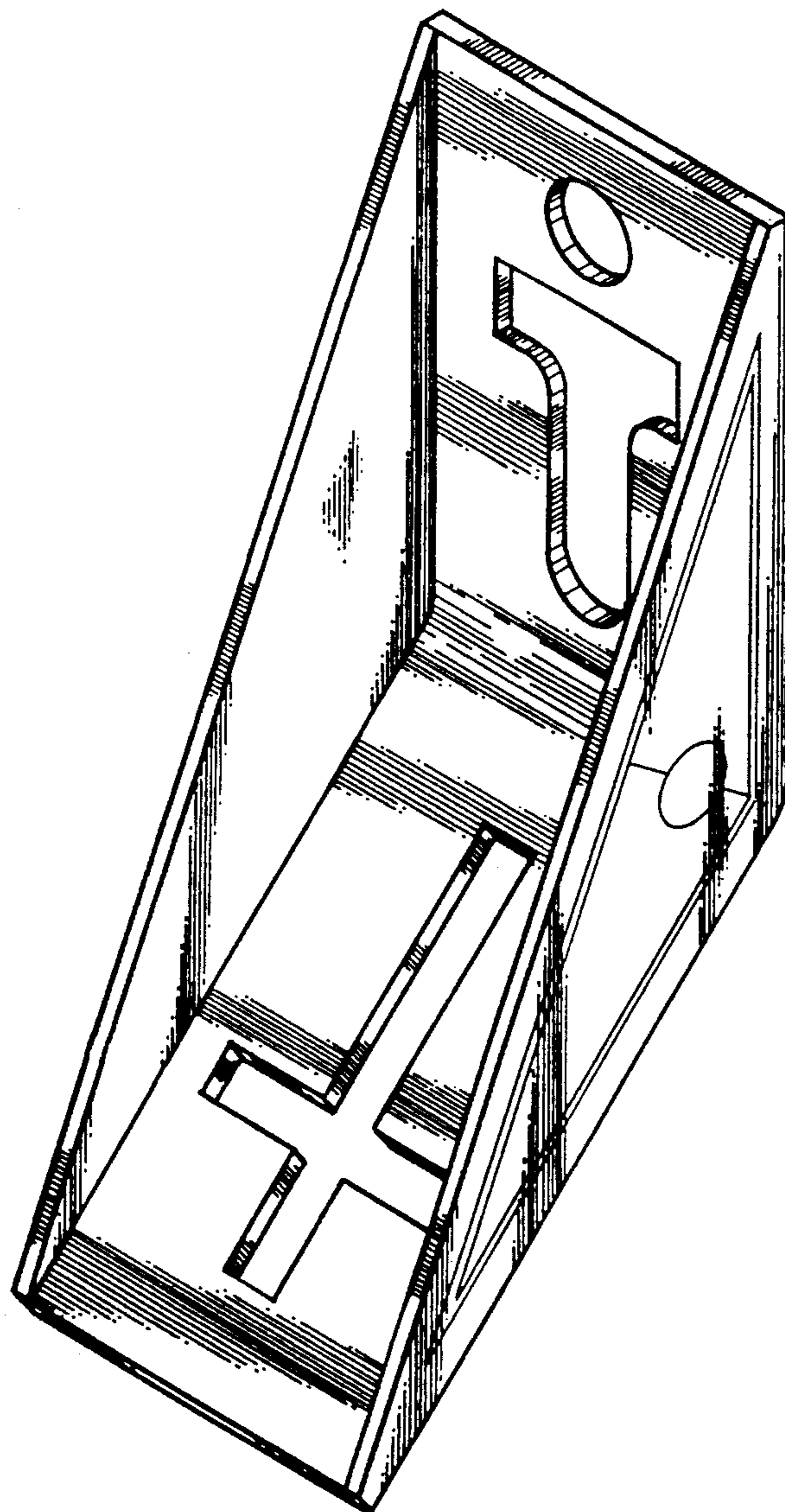

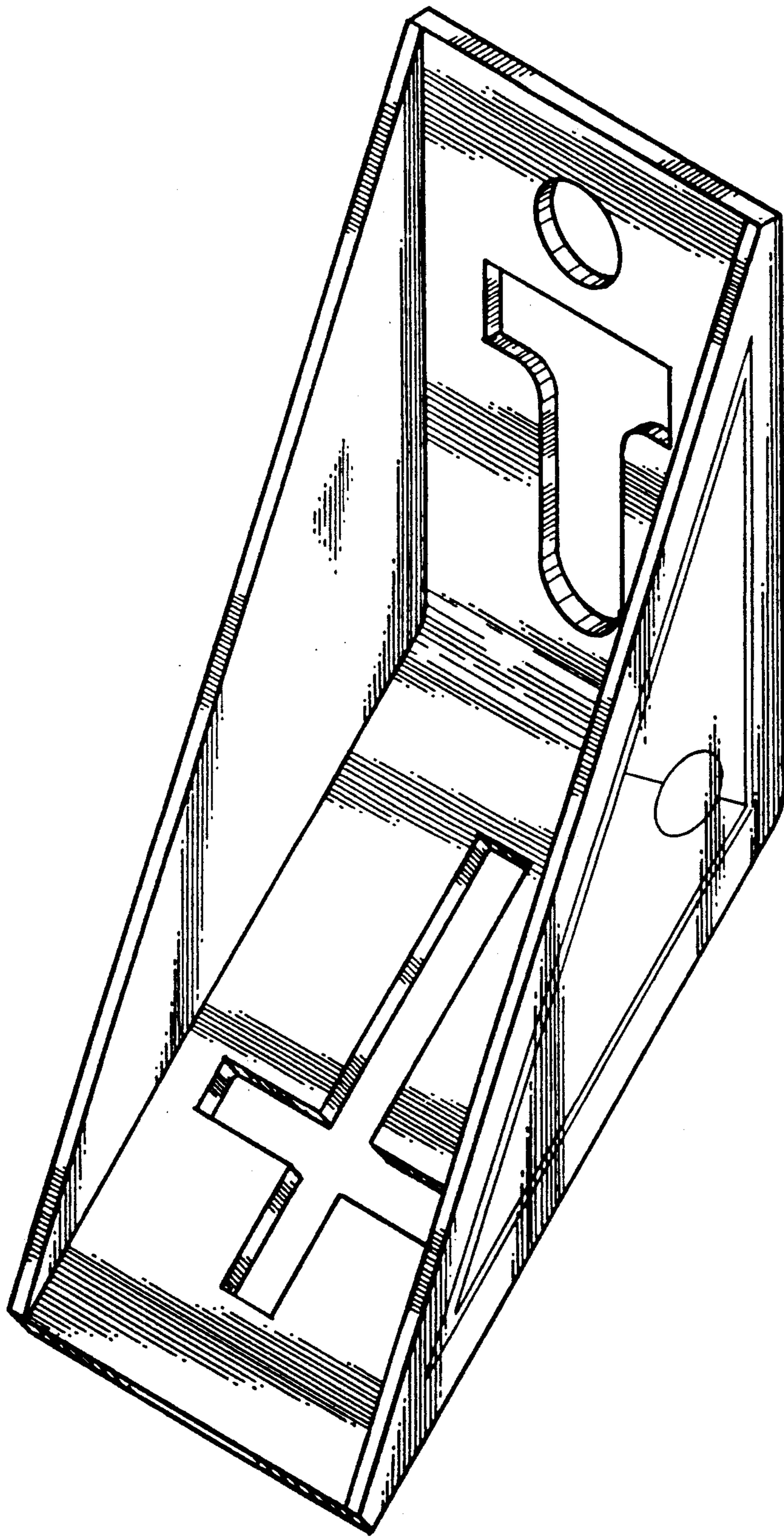

FIG. 1

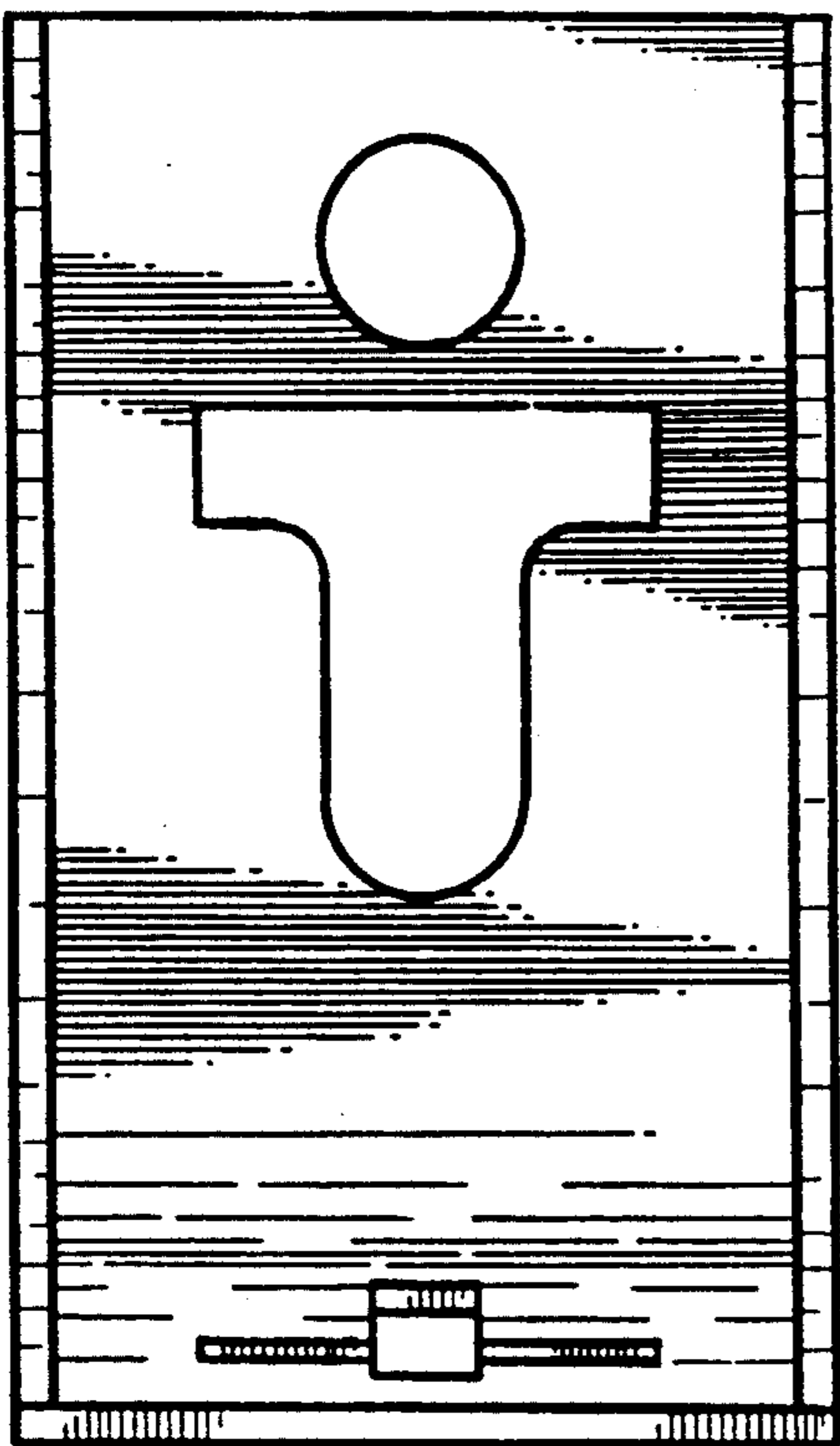

FIG. 2

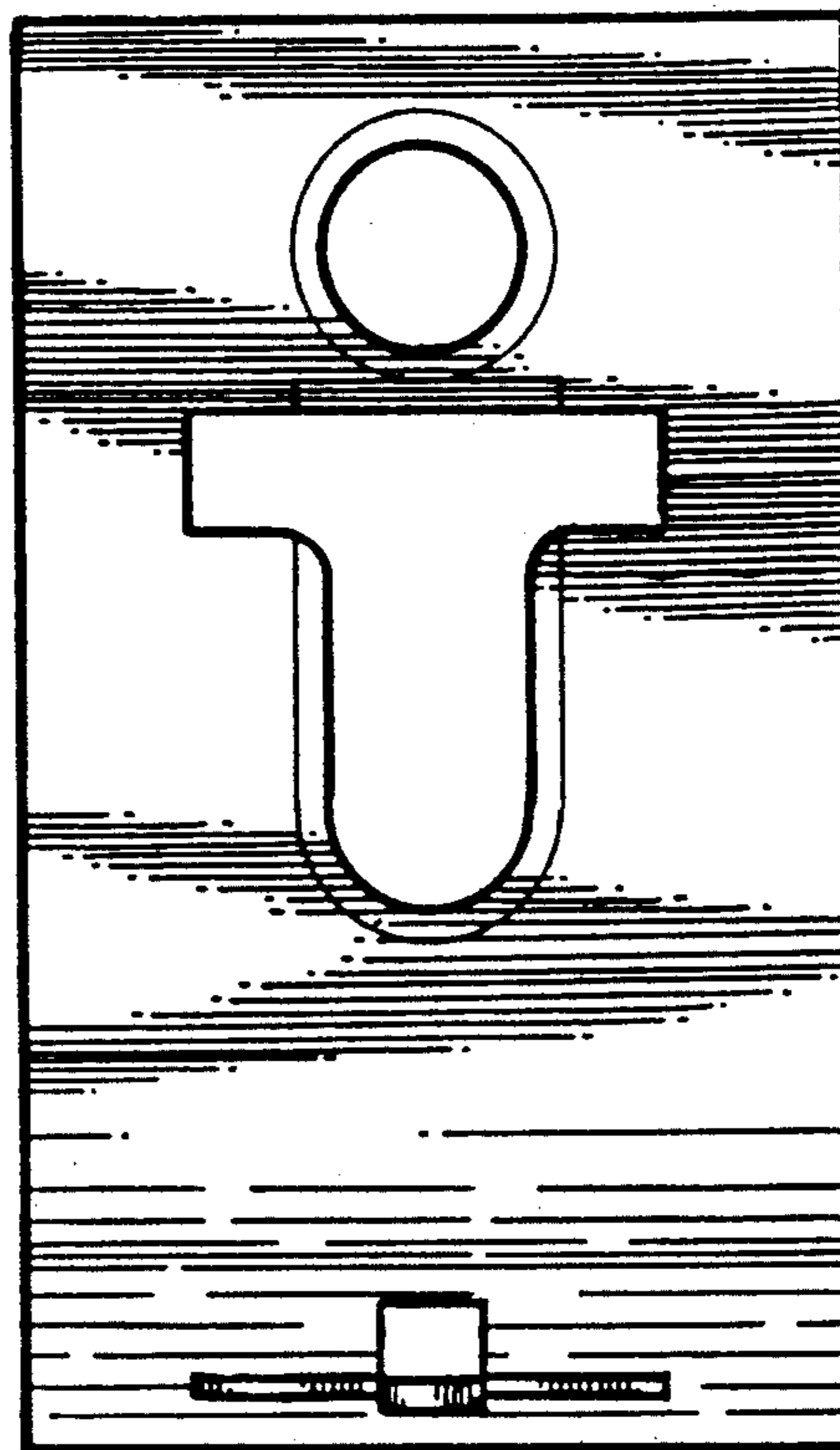
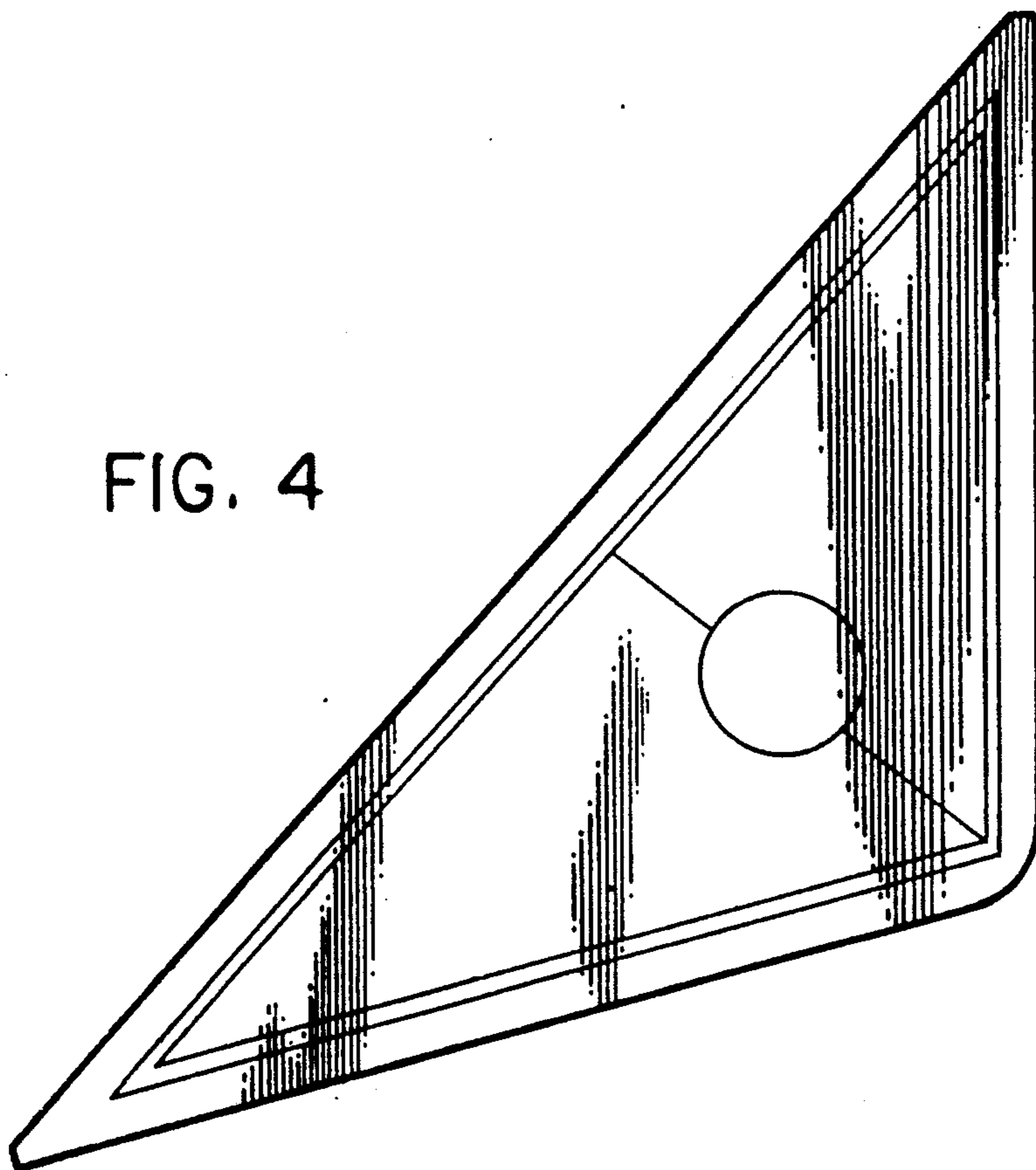

FIG. 3

FIG. 4



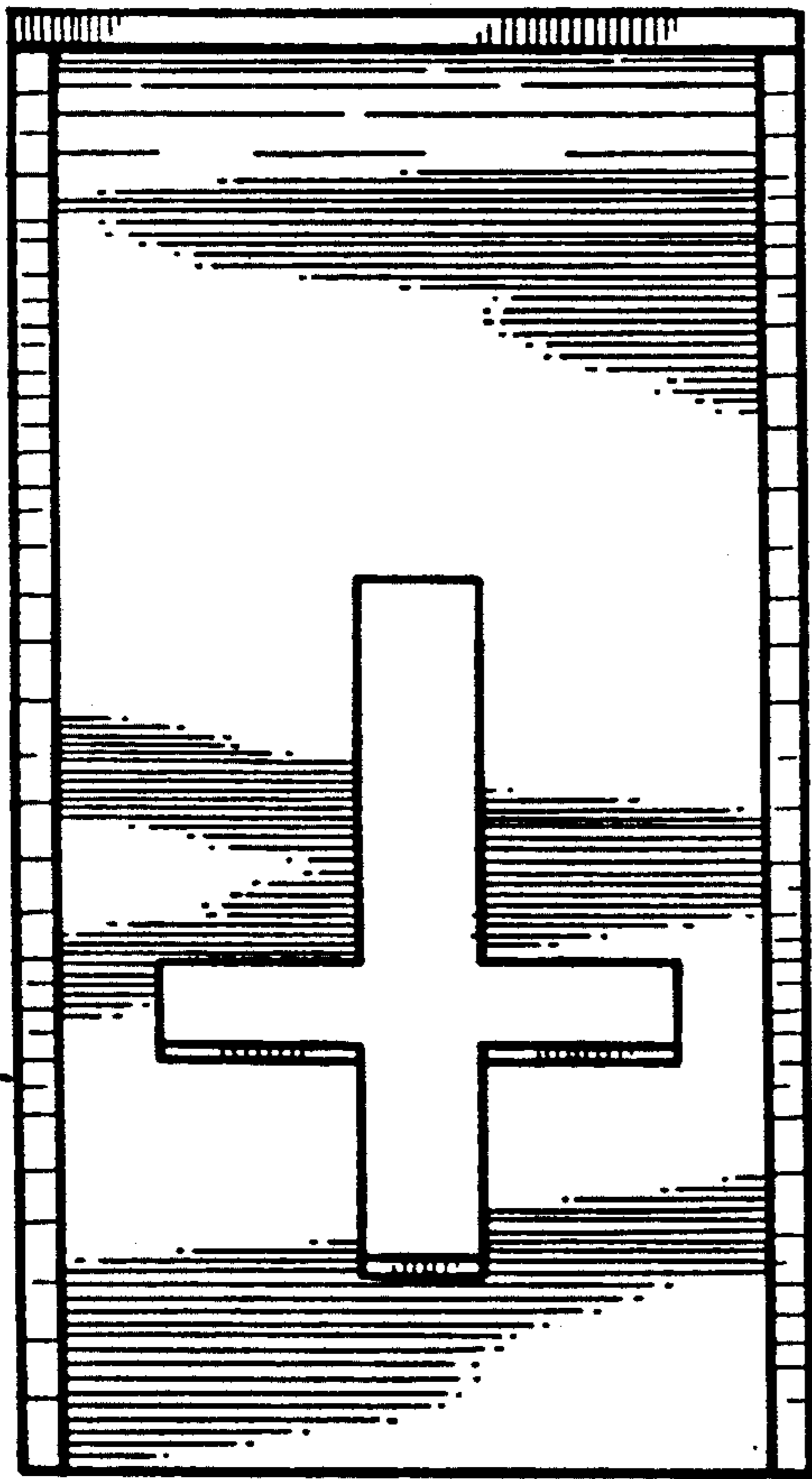

FIG. 5

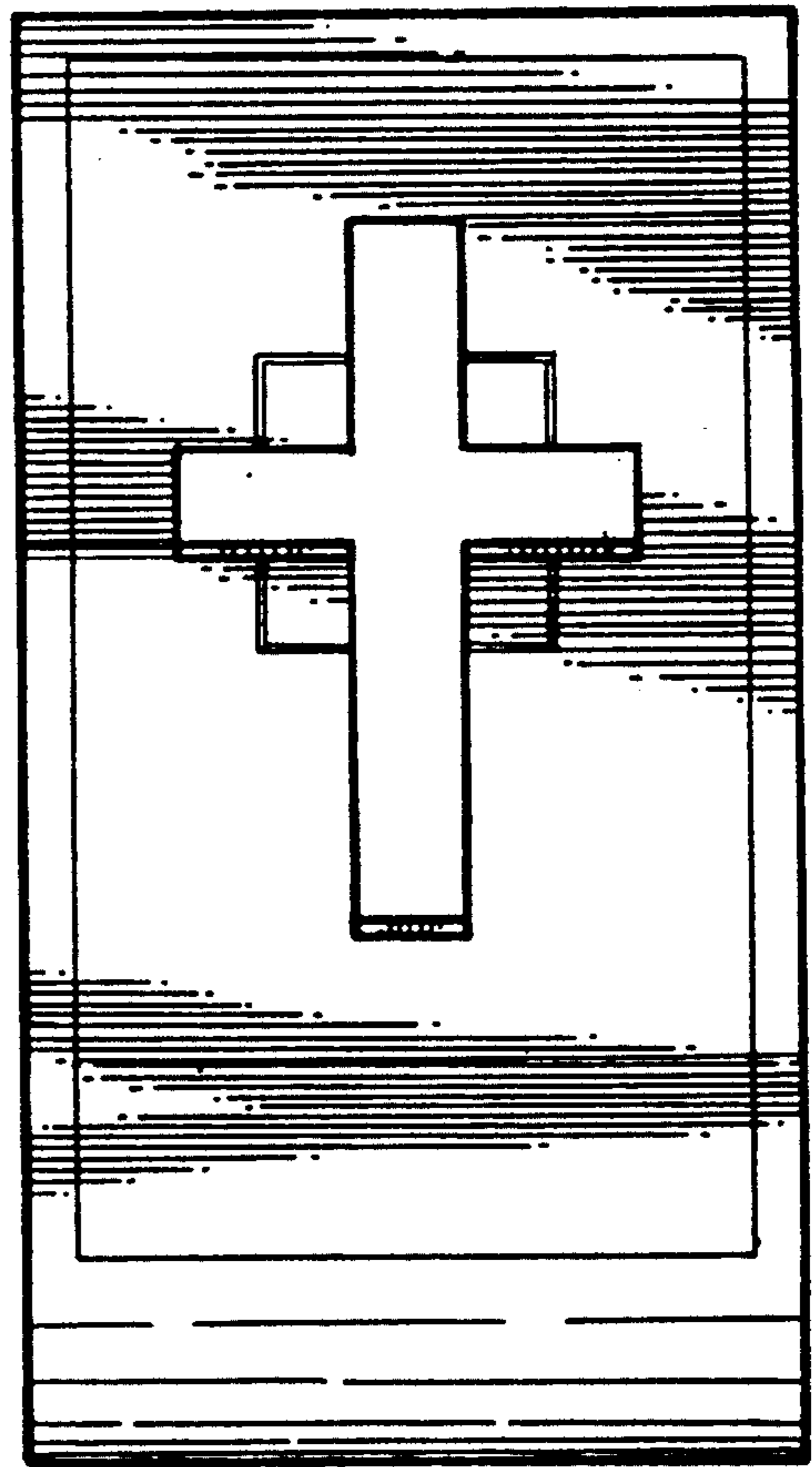

FIG. 6