



US00D337362S

# United States Patent [19]

[11] Patent Number: **Des. 337,362**

Goldstein et al.

[45] Date of Patent: **\*\* Jul. 13, 1993**

[54] **EXERCISE STEP**

[75] Inventors: **Eric Goldstein, Roswell; William J. Saunders, Lithonia; Edward Leftwich, Decatur, all of Ga.**

[73] Assignee: **The Step Company, Atlanta, Ga.**

[\*\*] Term: **14 Years**

[21] Appl. No.: **723,648**

[22] Filed: **Jul. 1, 1991**

[52] U.S. Cl. .... **D21/191**

[58] Field of Search ..... **D21/191; 482/52; D6/349, 367; 297/439; 108/144, 11, 12, 156**

[56] **References Cited**

**U.S. PATENT DOCUMENTS**

|            |         |                    |         |
|------------|---------|--------------------|---------|
| D. 267,969 | 2/1983  | Rodger .....       | D6/349  |
| D. 268,280 | 3/1983  | Rodger .....       | D6/349  |
| D. 280,052 | 8/1985  | Hyponen .....      | D6/349  |
| D. 298,266 | 10/1988 | Reyneke .....      | D21/191 |
| D. 313,521 | 1/1991  | Hassel et al. .... | D6/349  |
| D. 320,702 | 10/1991 | Dewing .....       | D6/349  |
| 4,984,785  | 1/1991  | Wilkinson .....    | 482/52  |
| 5,037,084  | 8/1991  | Flor .....         | 482/52  |
| 5,050,861  | 9/1991  | Thomas et al. .... | 482/52  |
| 5,069,444  | 12/1991 | Wilkinson .....    | 482/128 |

*Primary Examiner*—Bernard Ansher  
*Assistant Examiner*—P. Hyder

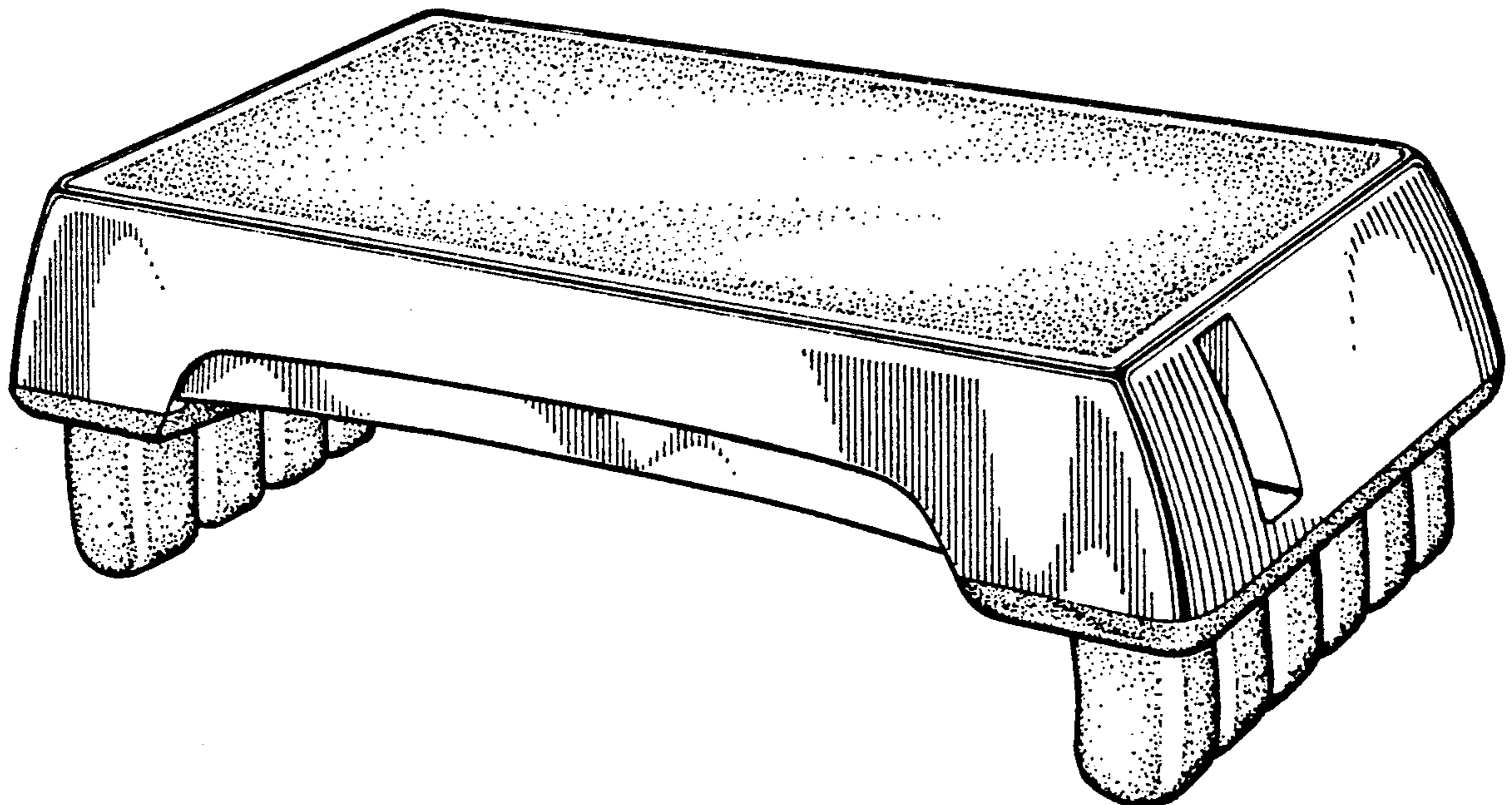
*Attorney, Agent, or Firm*—Needle & Rosenberg

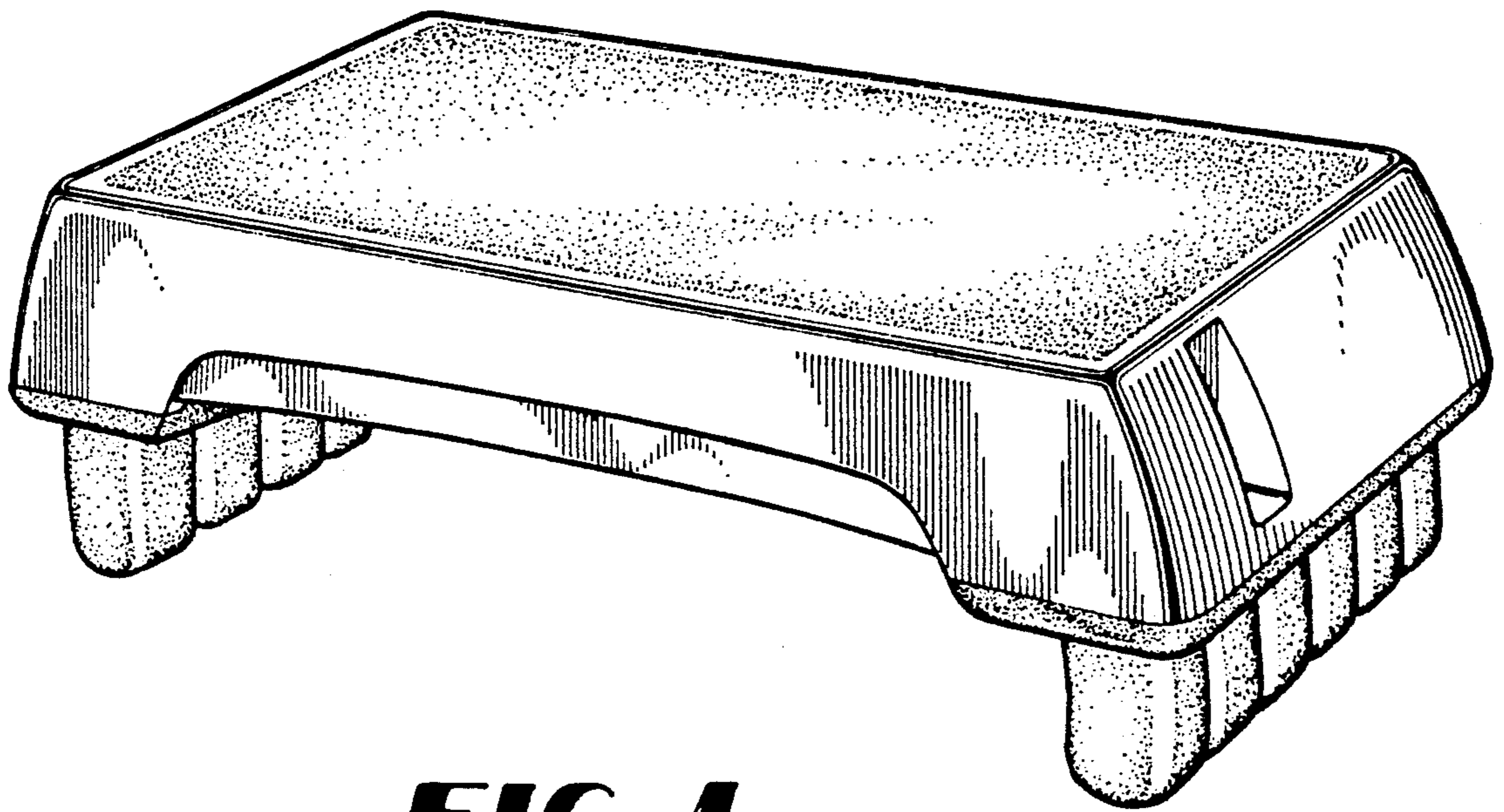
[57] **CLAIM**

The ornamental design for an exercise step, as shown.

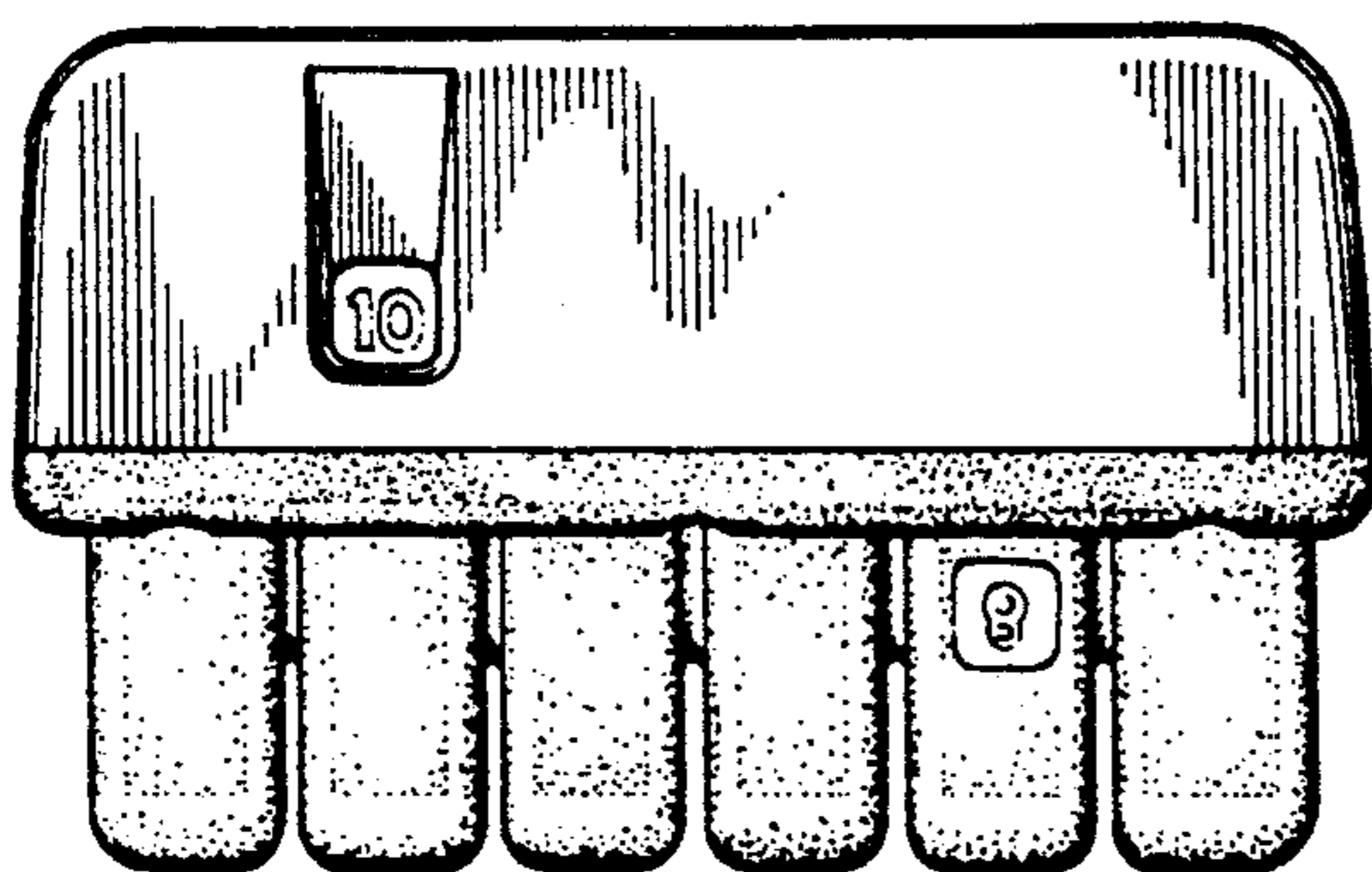
**DESCRIPTION**

FIG. 1 is a perspective view of an exercise step, showing my new design;  
 FIG. 2 is a right side elevational view thereof;  
 FIG. 3 is a left side elevation view thereof;  
 FIG. 4 is a front elevational view thereof;  
 FIG. 5 is a top plan view thereof;  
 FIG. 6 is a rear elevational view thereof;  
 FIG. 7 is a bottom plan view thereof;  
 FIG. 8 is a perspective view of a second modified embodiment thereof;  
 FIG. 9 is a right side elevational view thereof;  
 FIG. 10 is a left side elevational view thereof;  
 FIG. 11 is a front elevational view thereof;  
 FIG. 12 is a top plan view thereof;  
 FIG. 13 is a rear elevational view thereof;  
 FIG. 14 is a bottom plan view thereof;  
 FIG. 15 is a perspective view of a third modified embodiment thereof;  
 FIG. 16 is a right side elevational view thereof;  
 FIG. 17 is a left side elevational view thereof;  
 FIG. 18 is a front elevational view thereof;  
 FIG. 19 is a top plan view thereof;  
 FIG. 20 is a rear elevational view thereof; and,  
 FIG. 21 is a bottom plan view thereof.

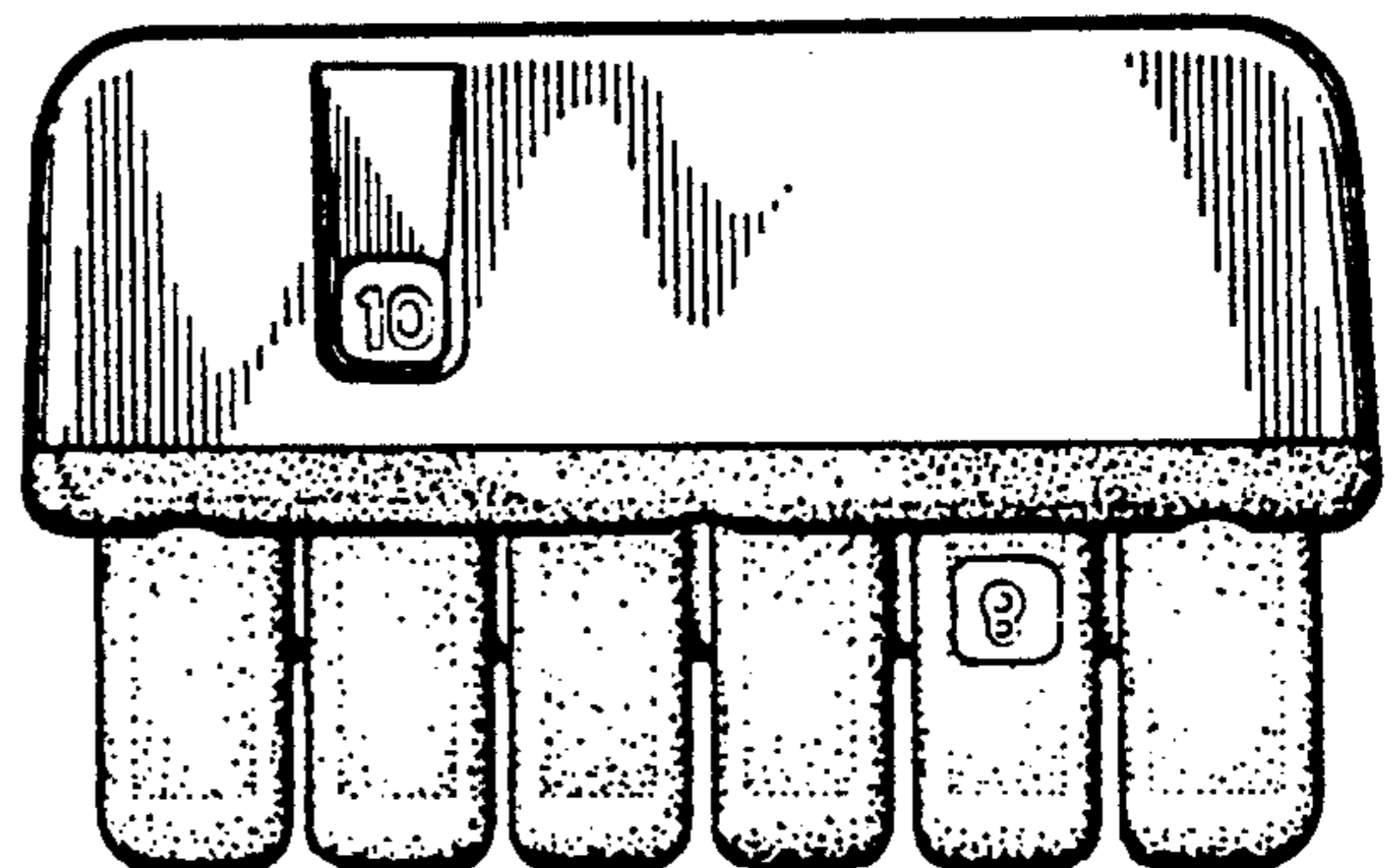




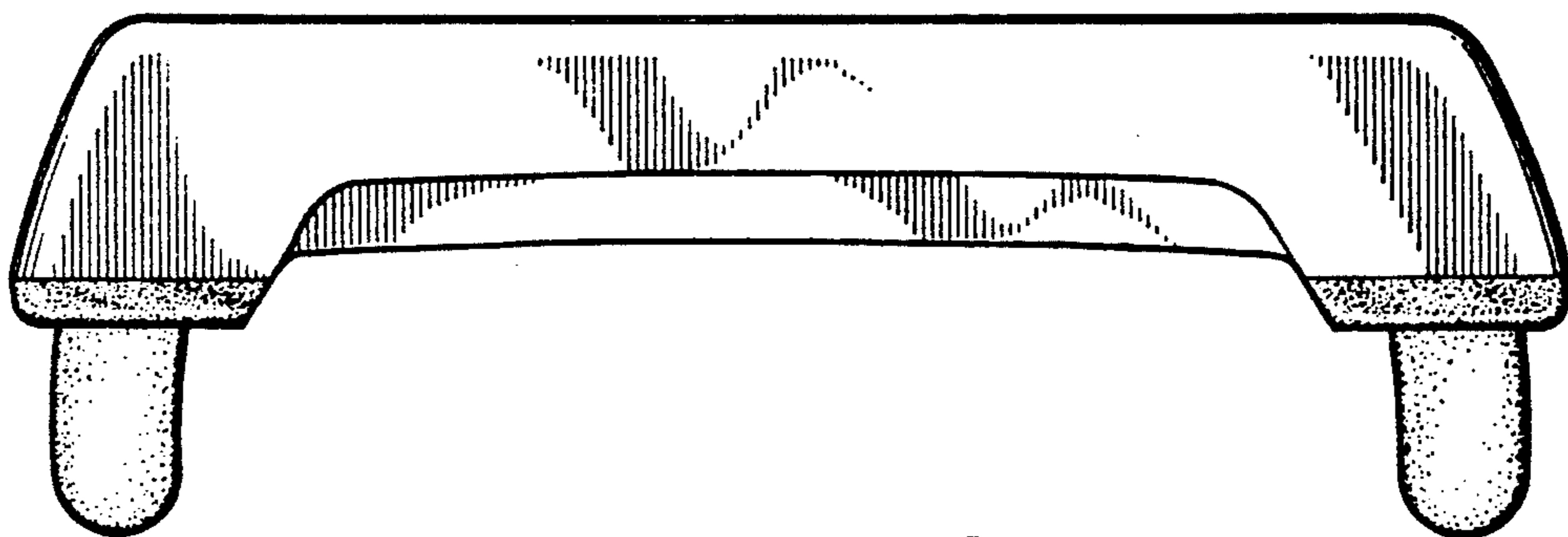
**FIG 1**



**FIG 2**



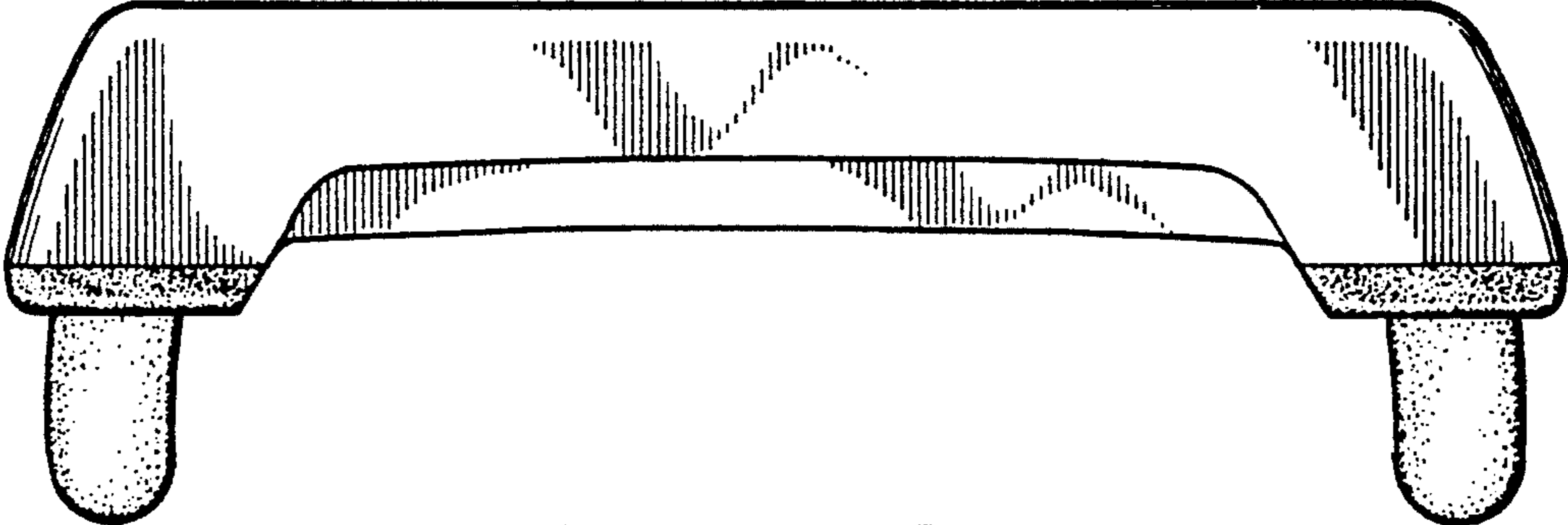
**FIG 3**



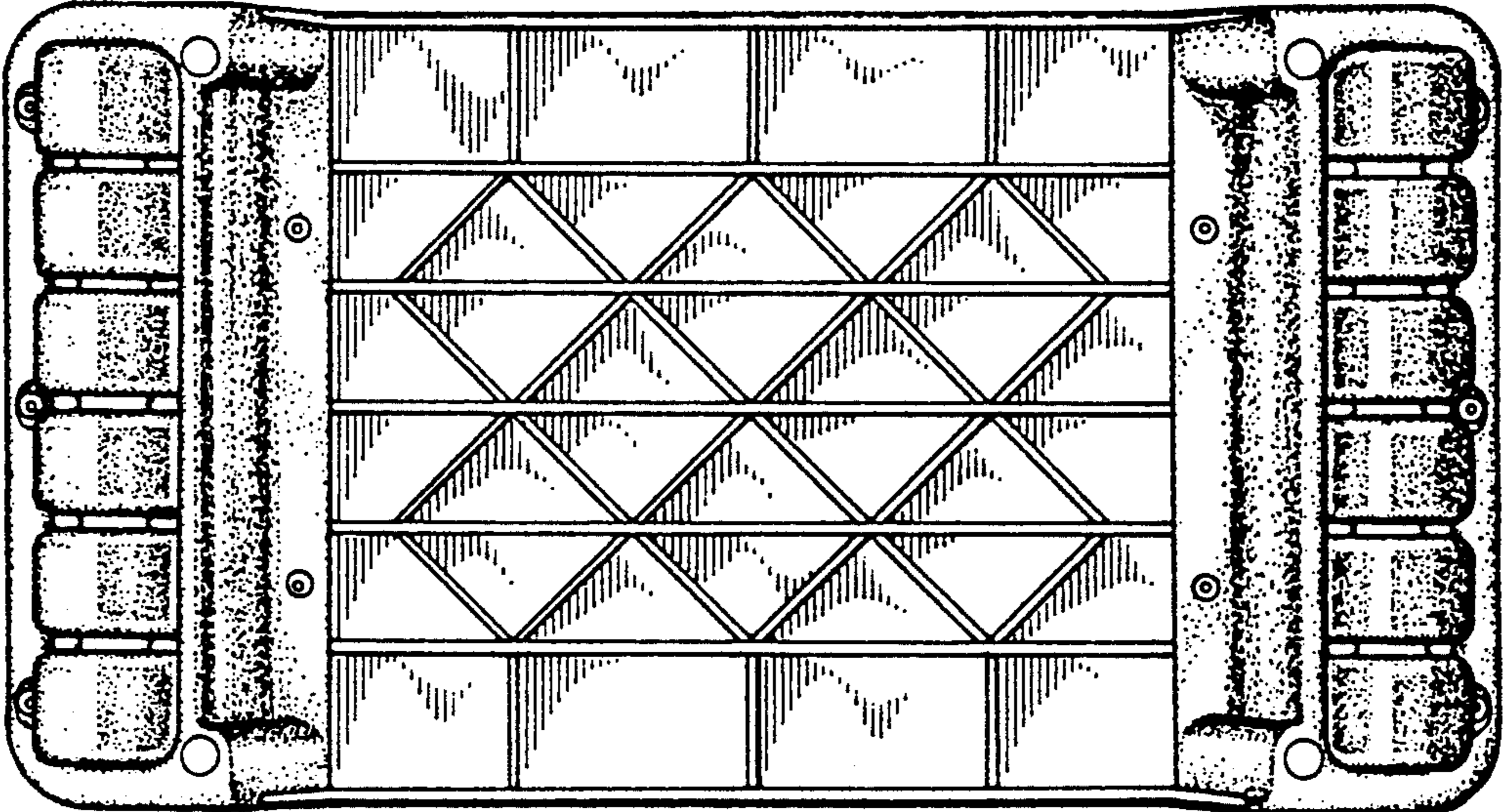
**FIG 4**



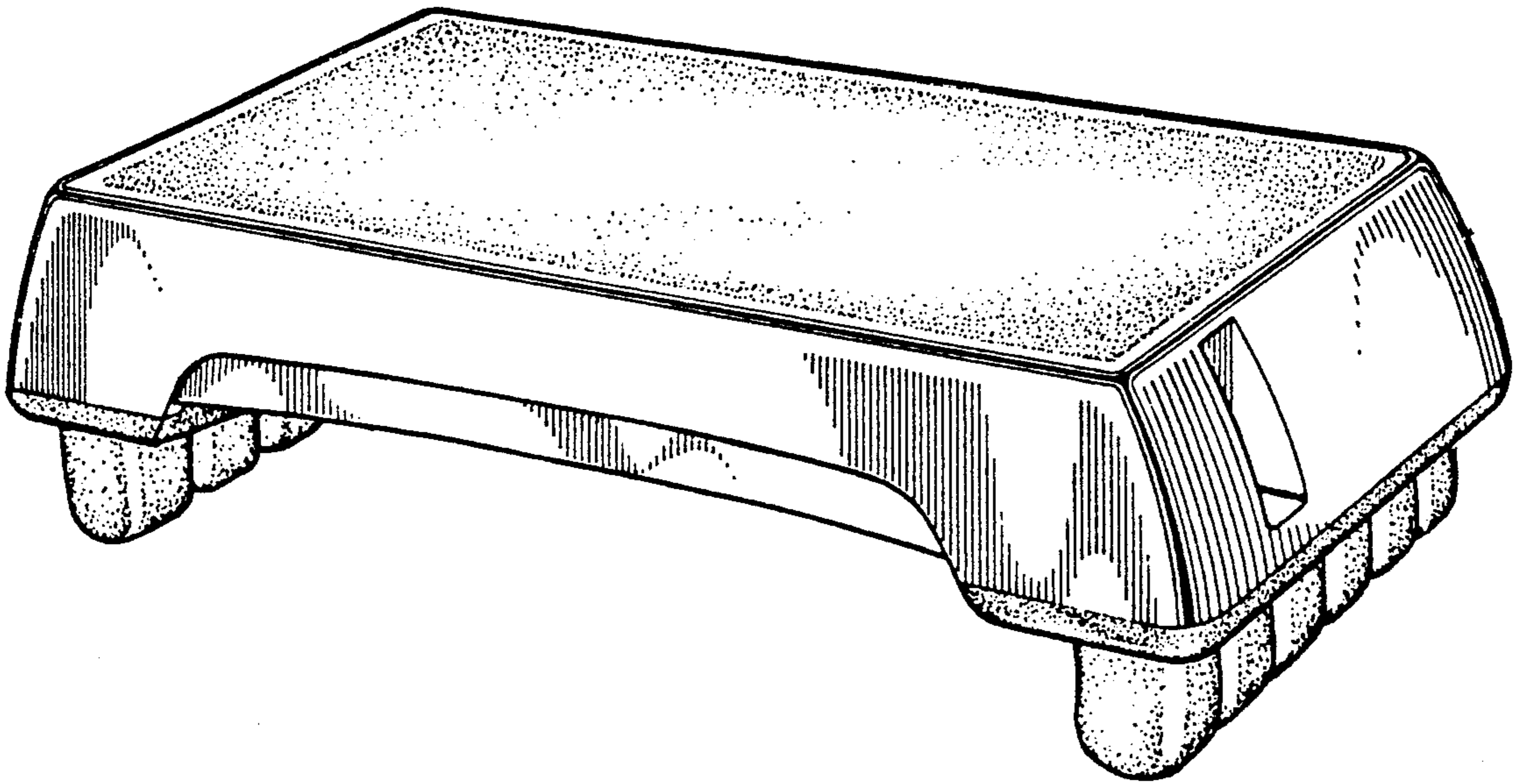
**FIG 5**



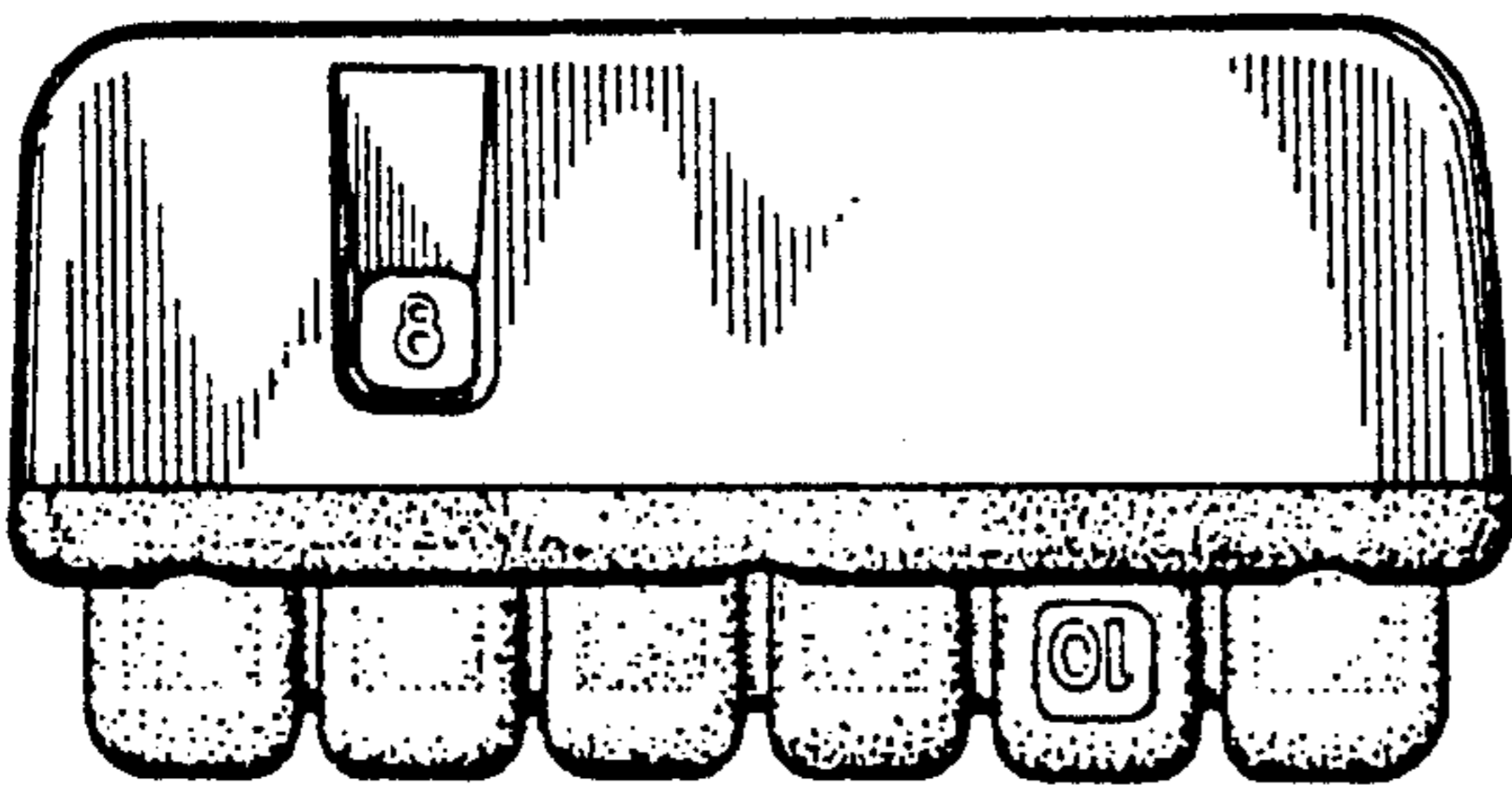
**FIG 6**



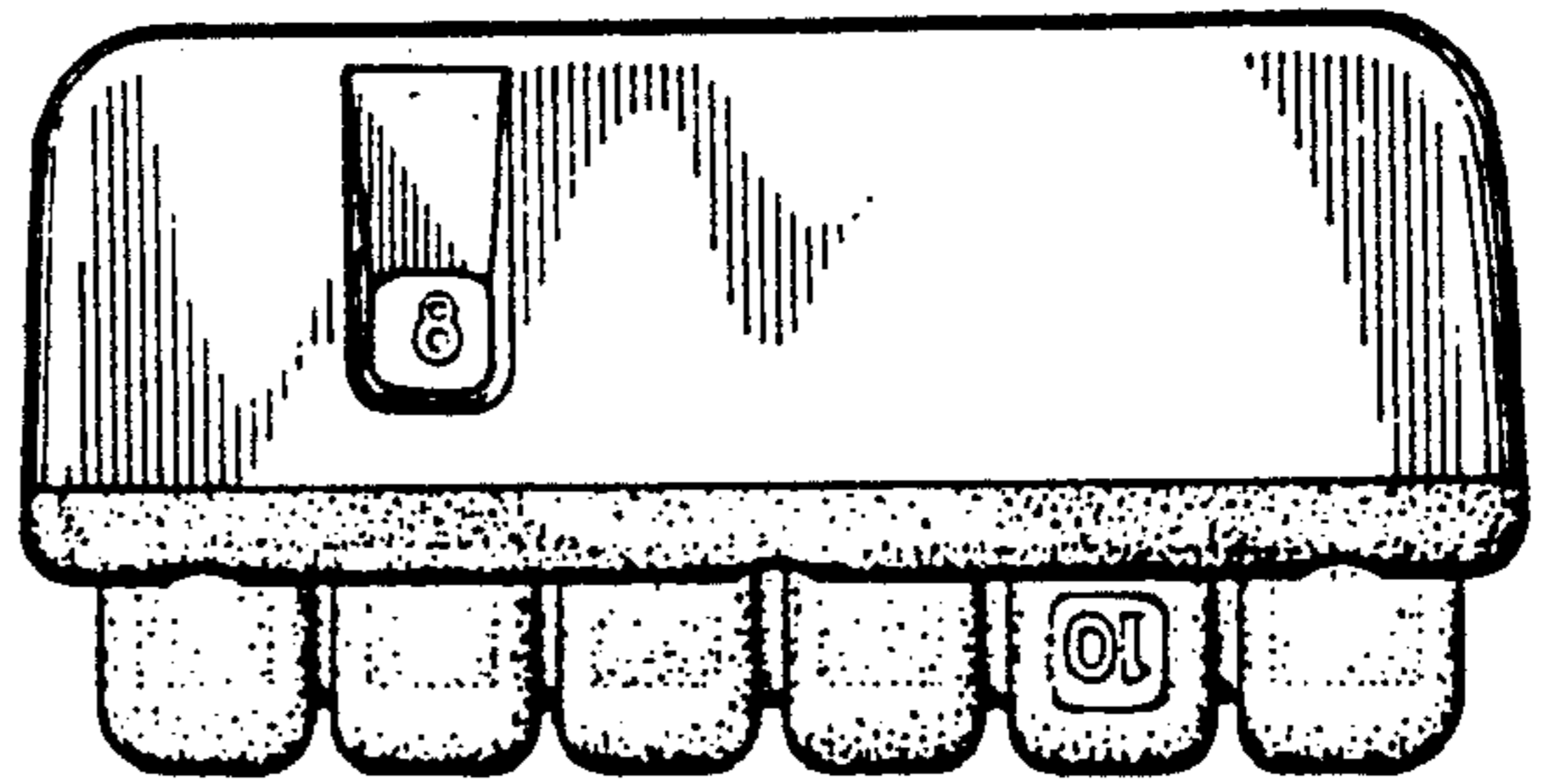
**FIG 7**



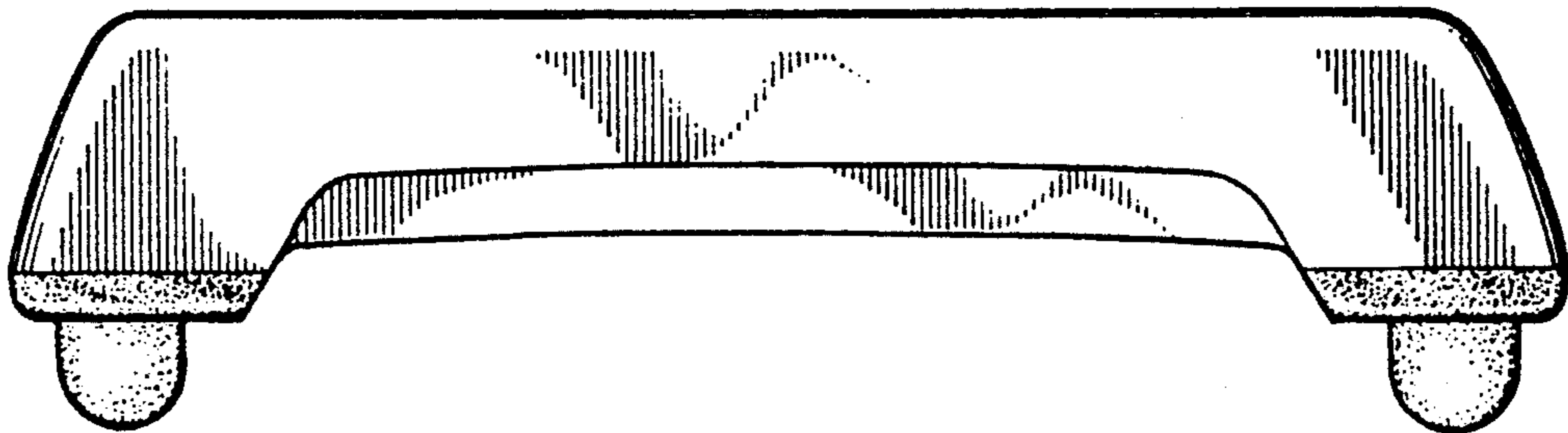
**FIG 8**



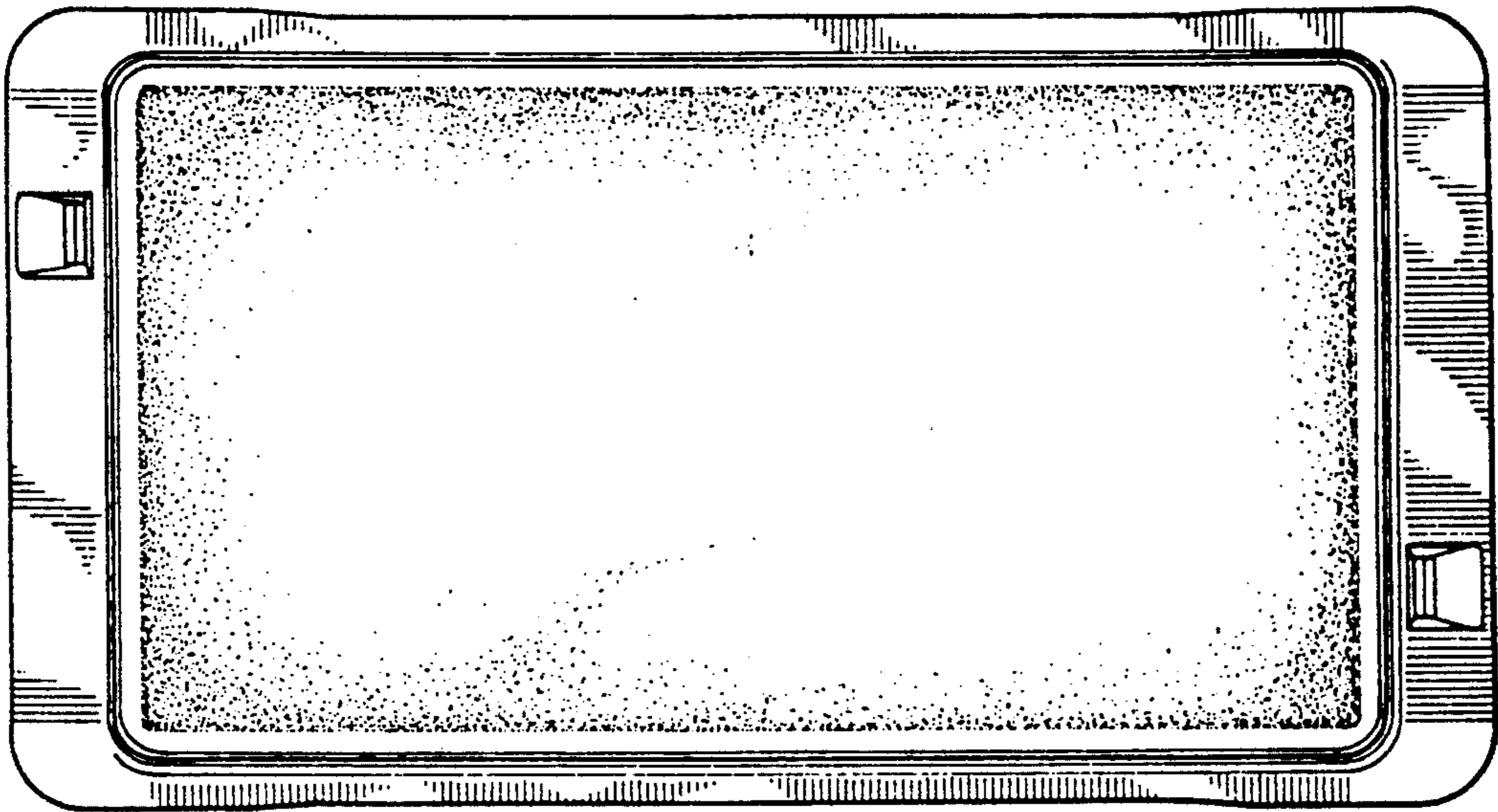
**FIG 9**



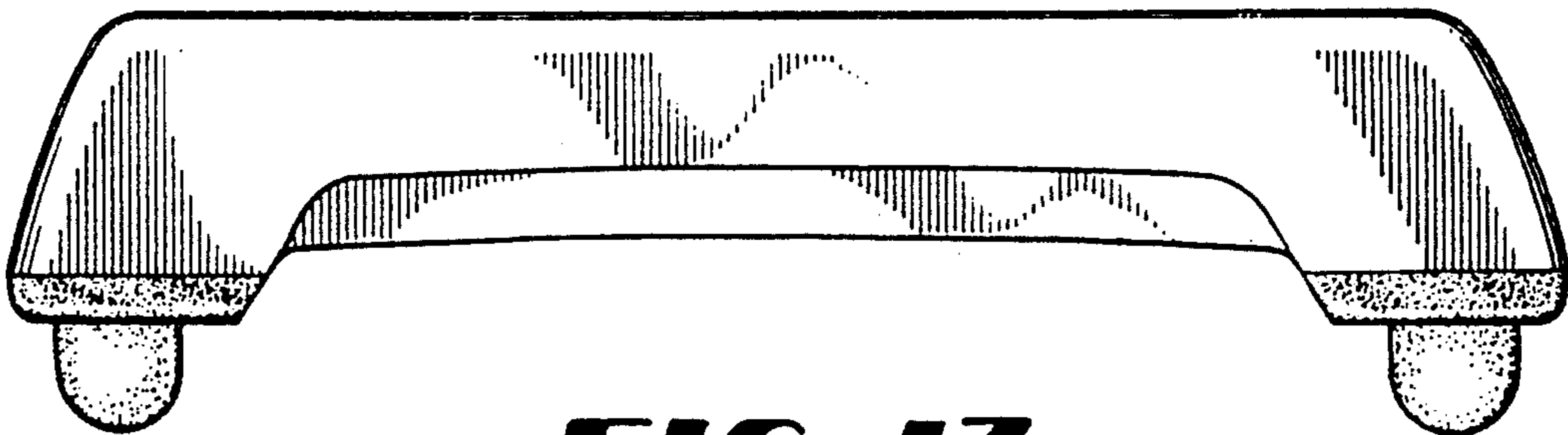
**FIG 10**



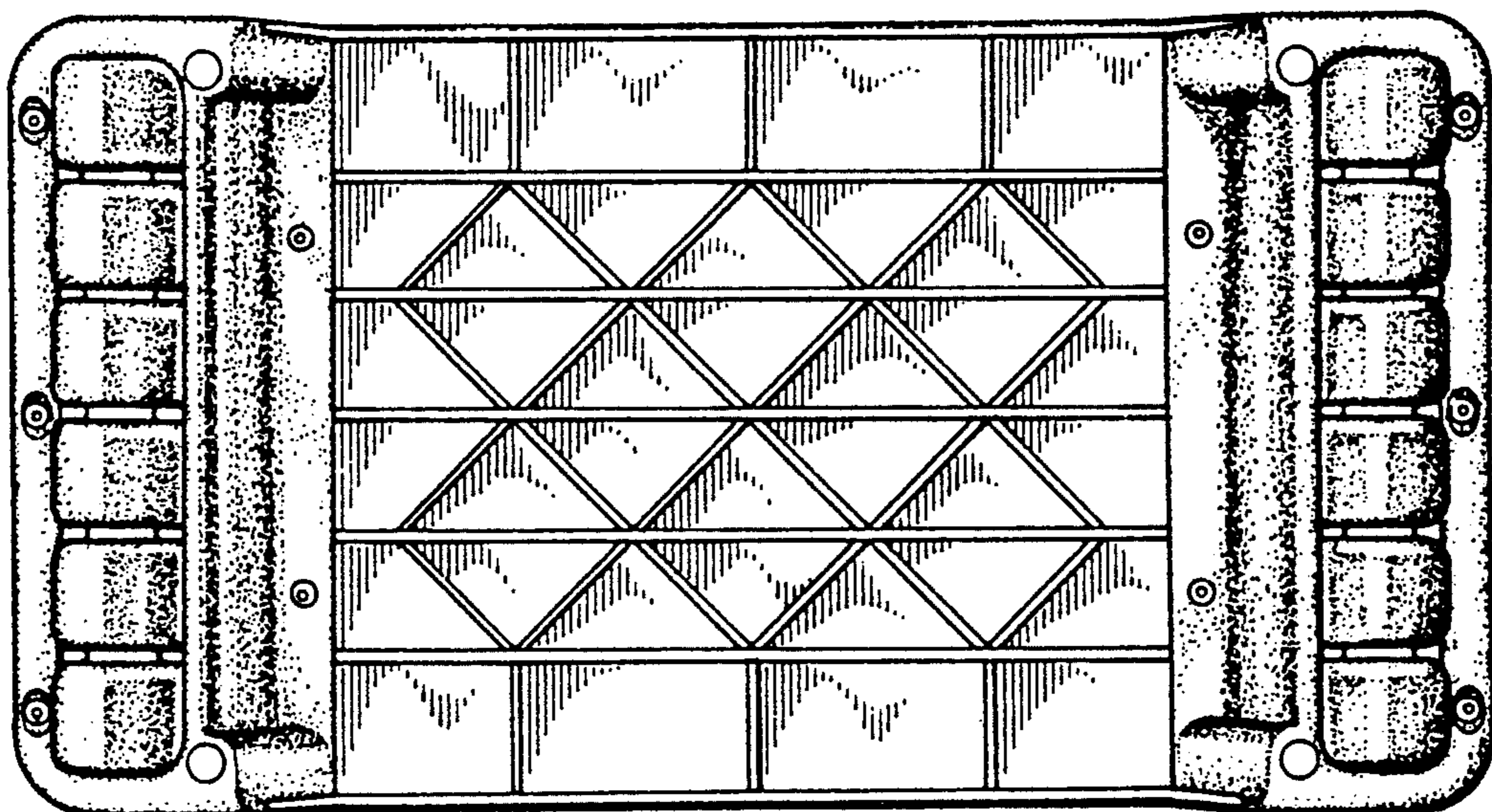
**FIG 11**



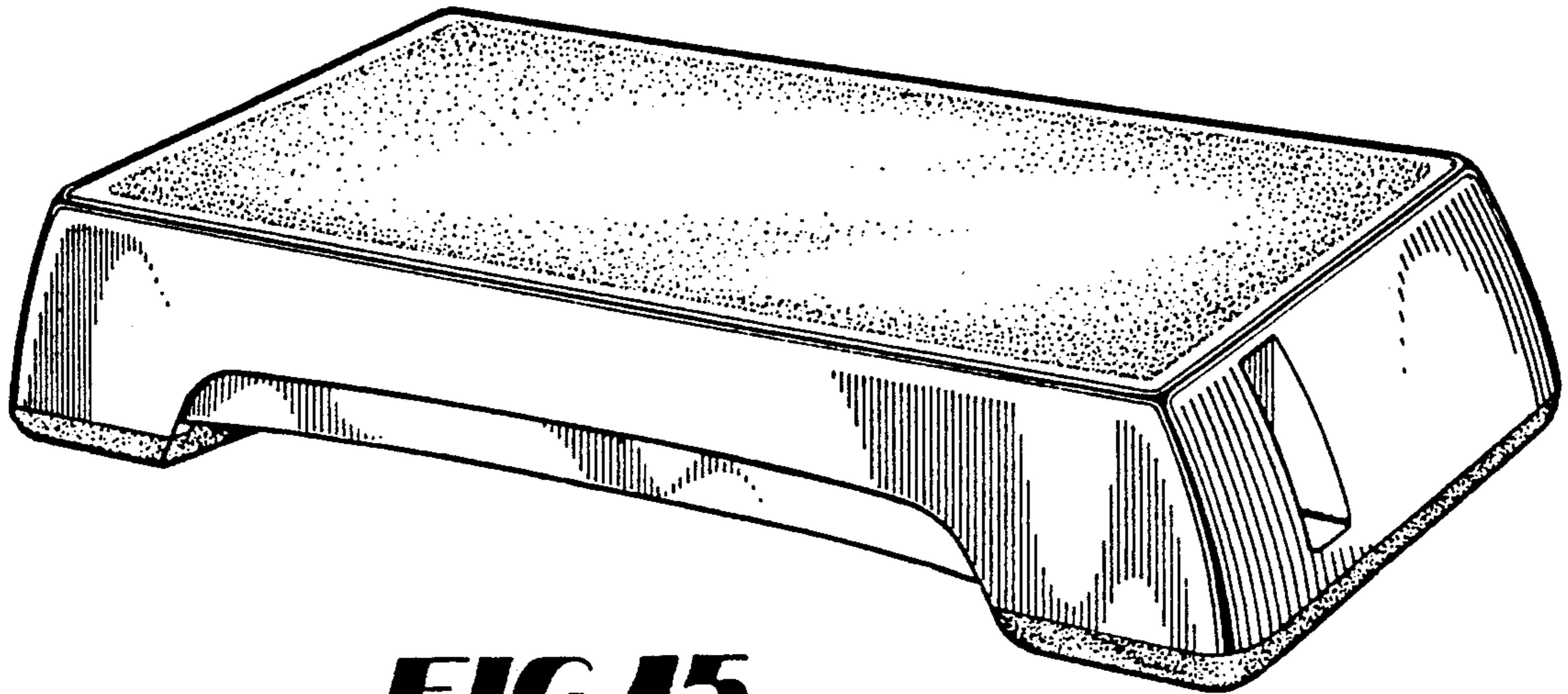
**FIG 12**



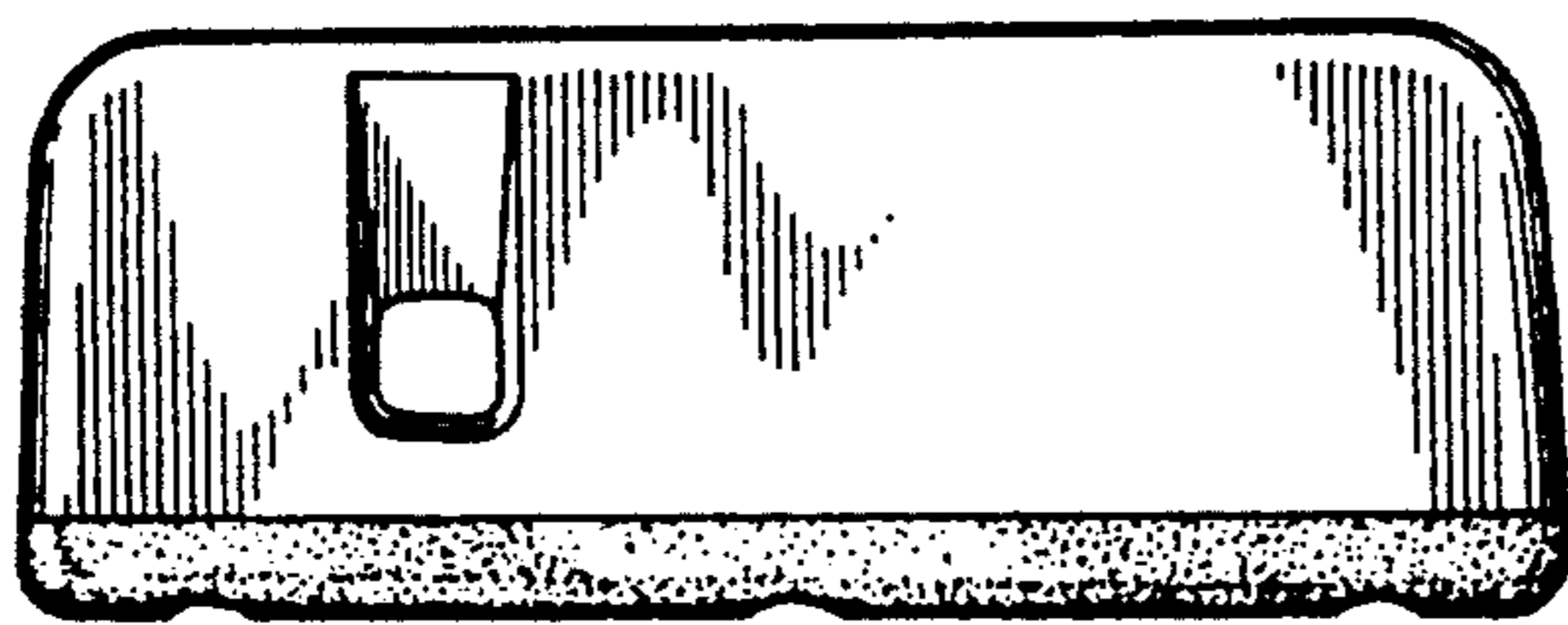
**FIG 13**



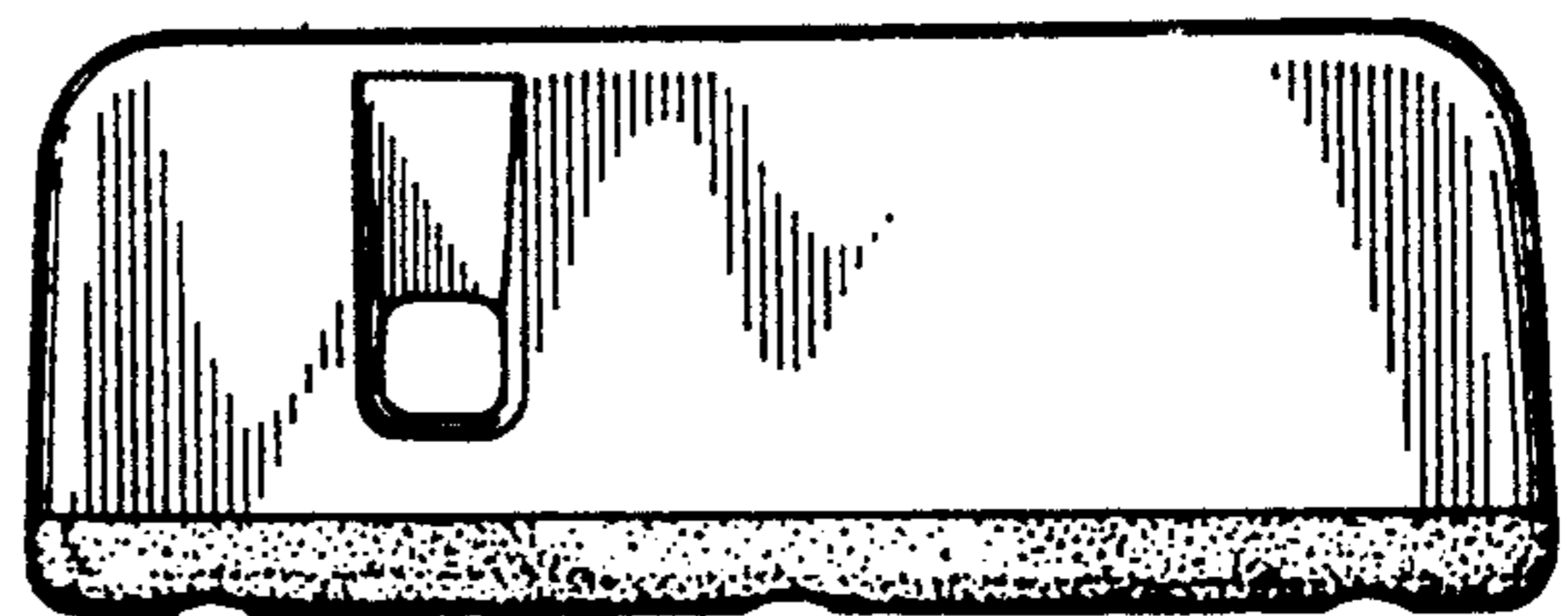
**FIG 14**



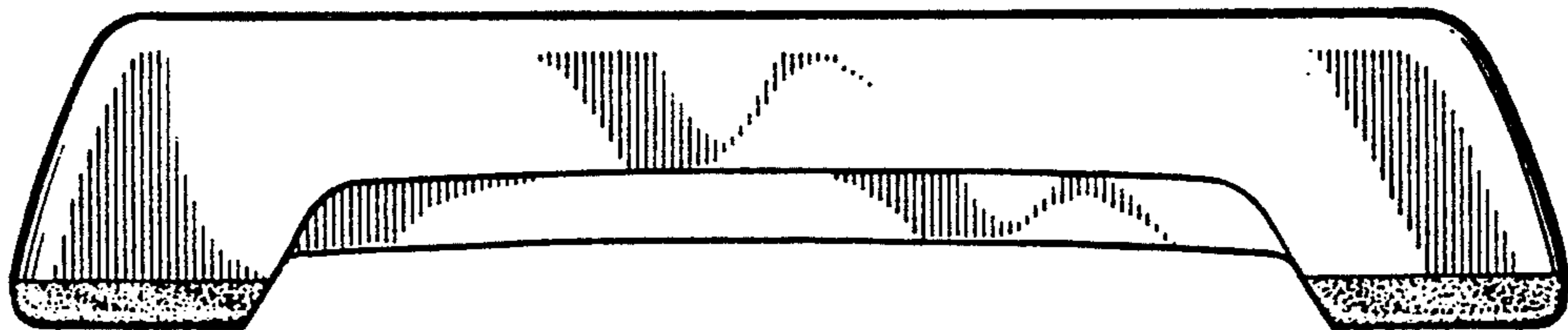
**FIG. 15**



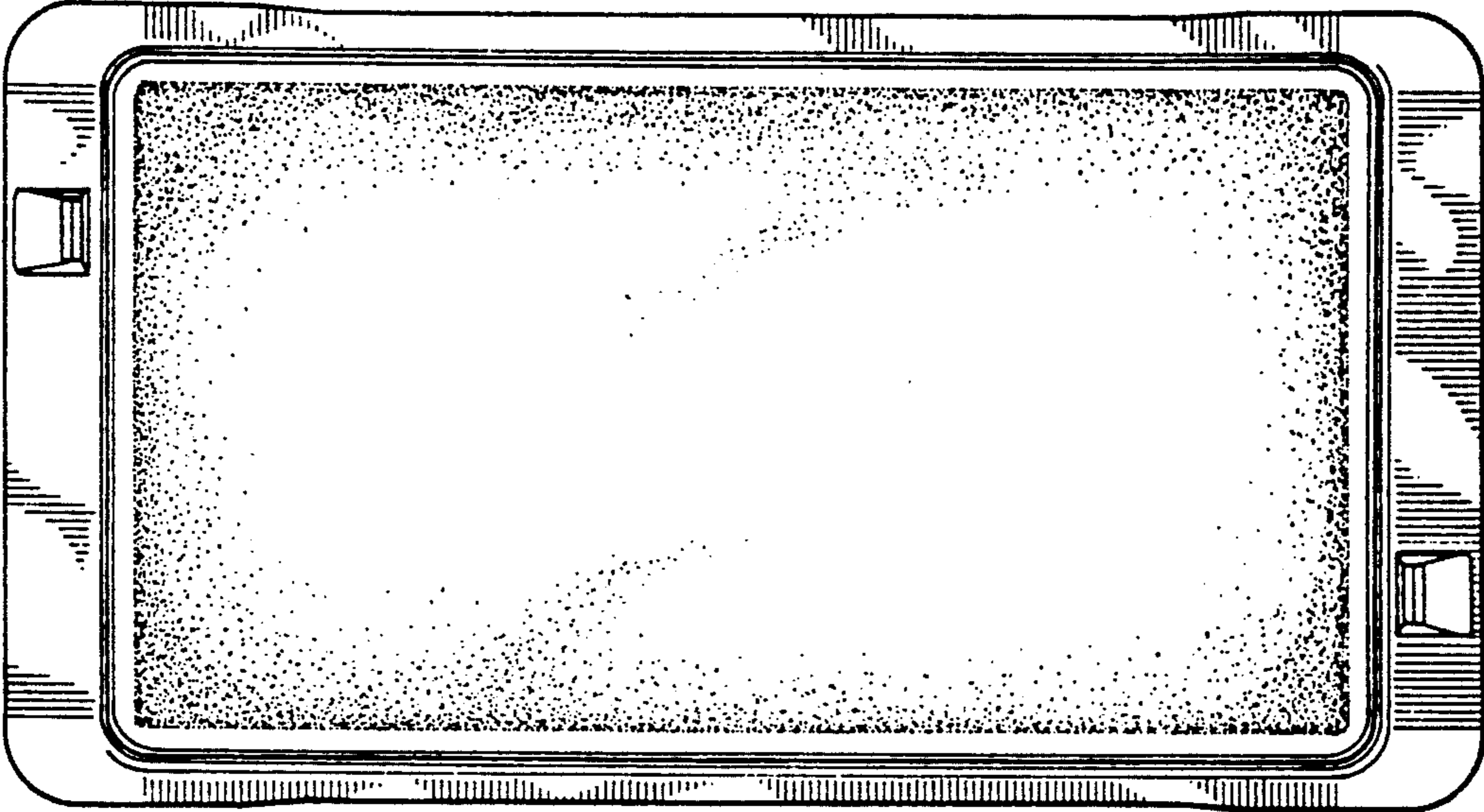
**FIG. 16**



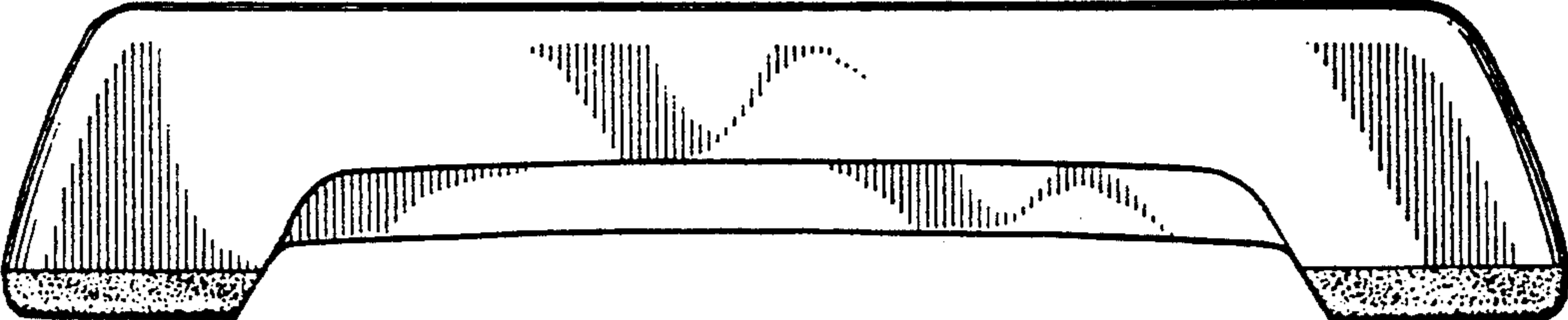
**FIG. 17**



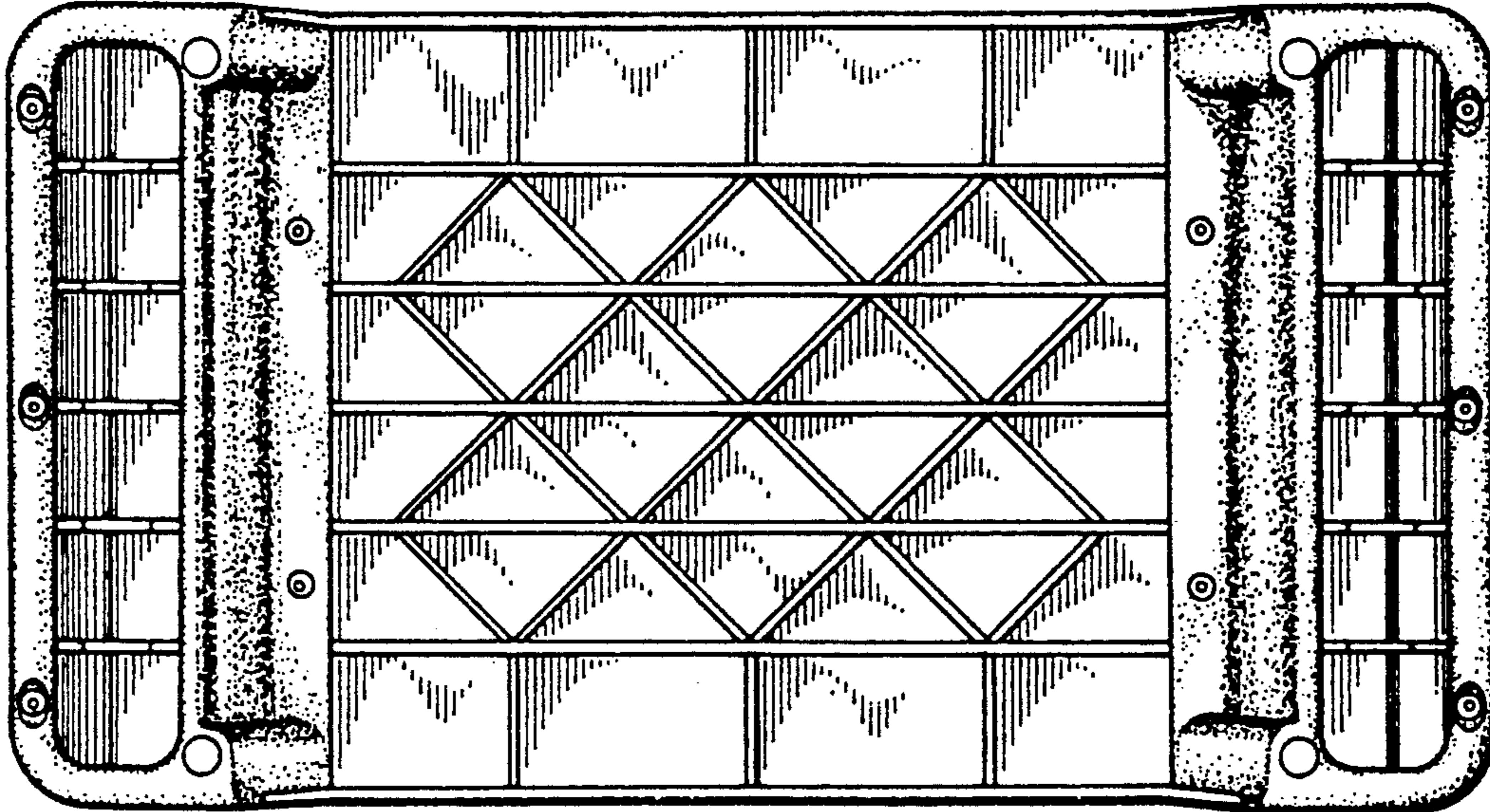
**FIG. 18**



**FIG 19**



**FIG 20**



**FIG 21**