



US00D337221S

**United States Patent** [19]  
**Stegeman**

[11] **Patent Number: Des. 337,221**

[45] **Date of Patent: \*\* Jul. 13, 1993**

[54] **WRITING DESK**

[75] **Inventor: Berend J. Stegeman, Breda, Netherlands**

[73] **Assignee: Assenburg B.V., Tilburg, Netherlands**

[\*\*] **Term: 14 Years**

[21] **Appl. No.: 680,287**

[22] **Filed: Apr. 4, 1991**

[30] **Foreign Application Priority Data**

Oct. 4, 1990 [WO] World Int. Prop.  
O. .... DMA/001355

[52] **U.S. Cl. .... D6/484; D6/429**

[58] **Field of Search .... D6/480, 482-489, D6/495, 496, 498, 499, 423, 429; 108/144, 145; 312/195, 198**

[56] **References Cited**

**U.S. PATENT DOCUMENTS**

D. 284,532 7/1986 Vogt ..... D6/429 X  
D. 288,750 3/1987 Friedman ..... D6/429  
D. 312,928 12/1990 Scheffers ..... D6/429  
D. 320,709 10/1991 Lotsch et al. .... D6/423

**OTHER PUBLICATIONS**

Krueger GSA/Furniture, p. 5 Data Bord 920 brochure.

*Primary Examiner*—Nelson C. Holtje

*Assistant Examiner*—J. E. Seeger

*Attorney, Agent, or Firm*—Ladas & Parry

[57] **CLAIM**

The ornamental design for a writing desk, as shown.

**DESCRIPTION**

FIG. 1 is a perspective view of the design;  
FIG. 2 is a rear view of the design;  
FIG. 3 is a right side view of the design;  
FIG. 4 is a left side view of the design;  
FIG. 5 is a front view of the design;  
FIG. 6 is a plan view of the design; and,  
FIG. 7 is a bottom view of the design.

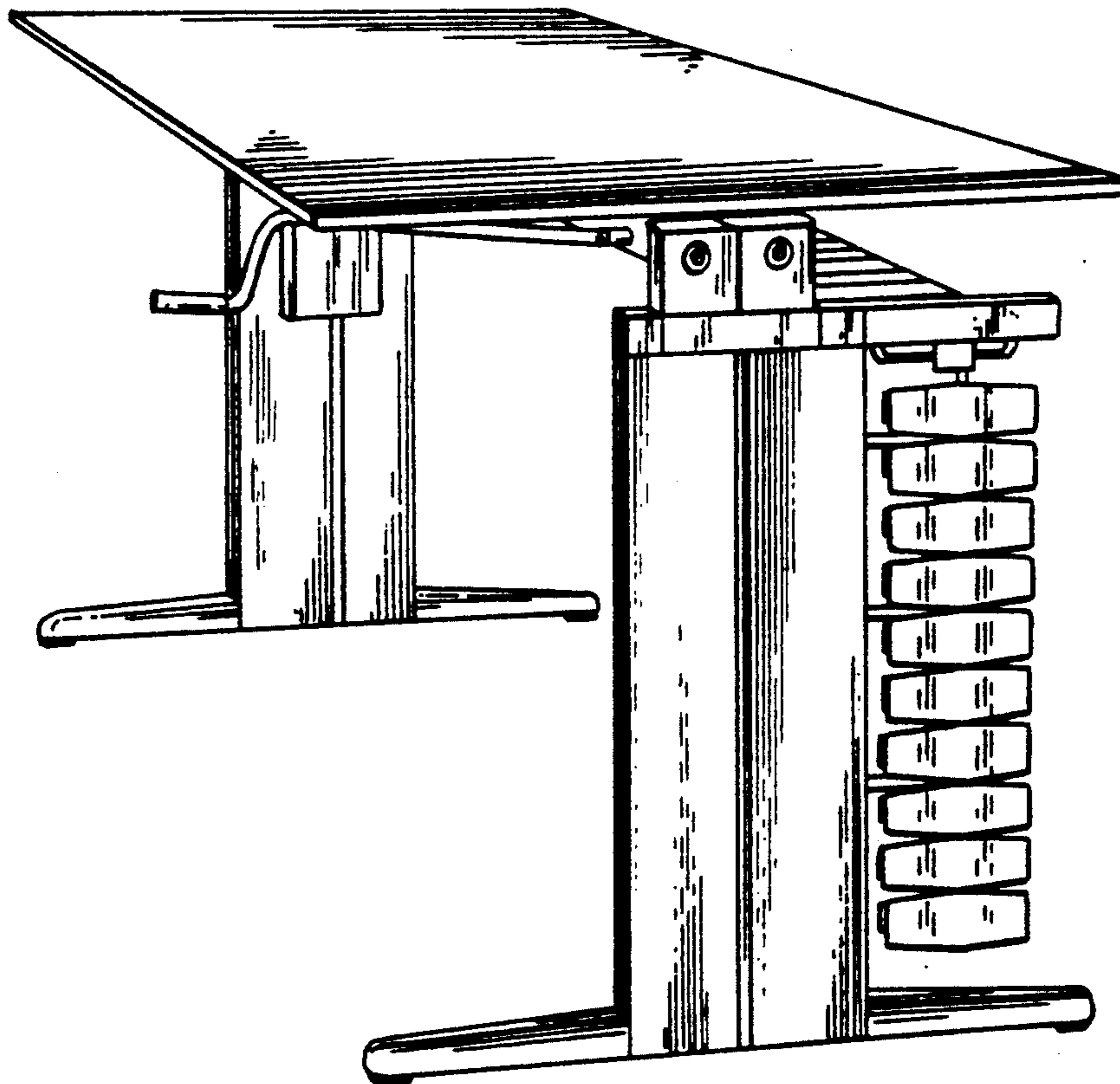

FIG. 1

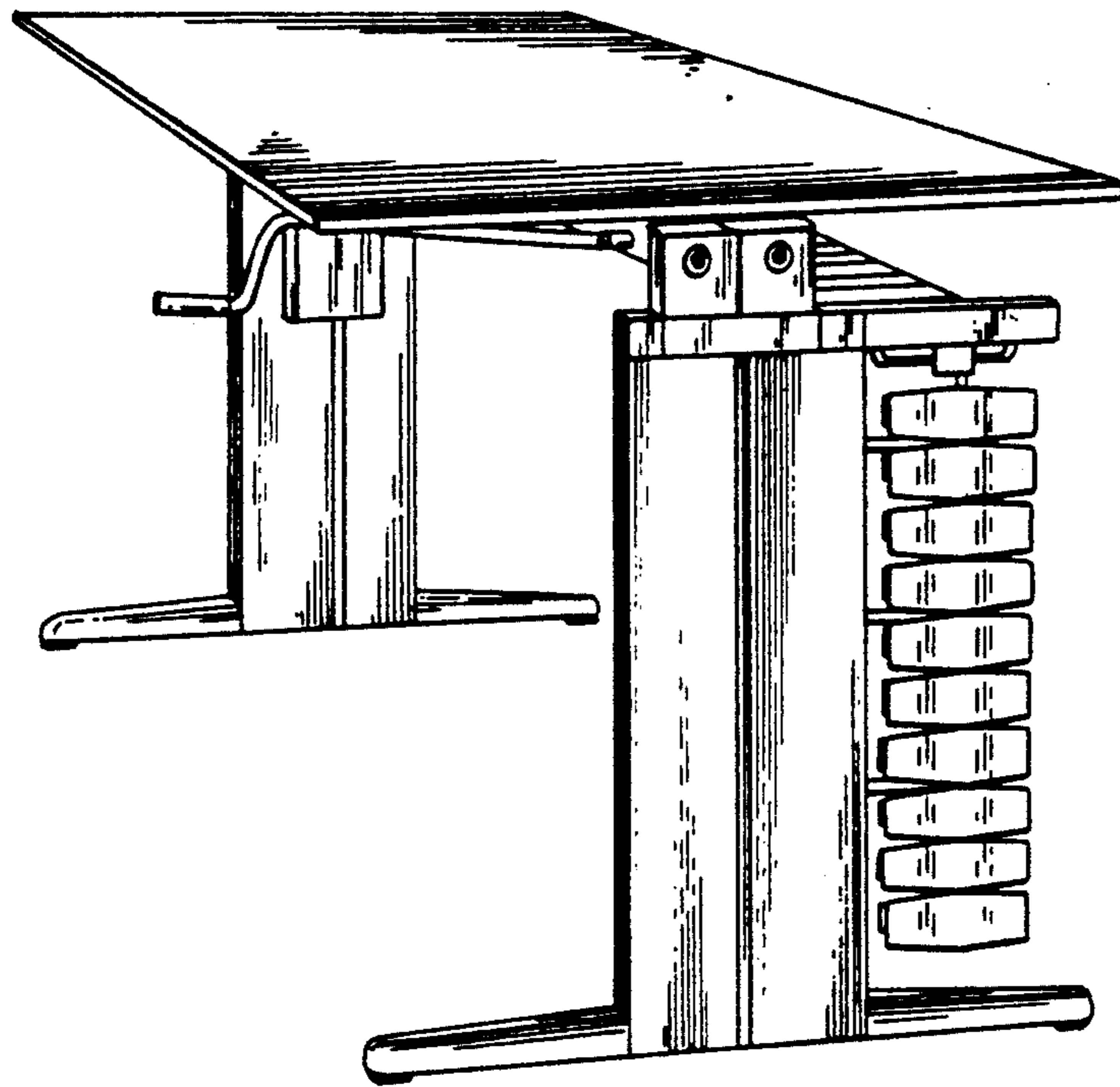

FIG. 2

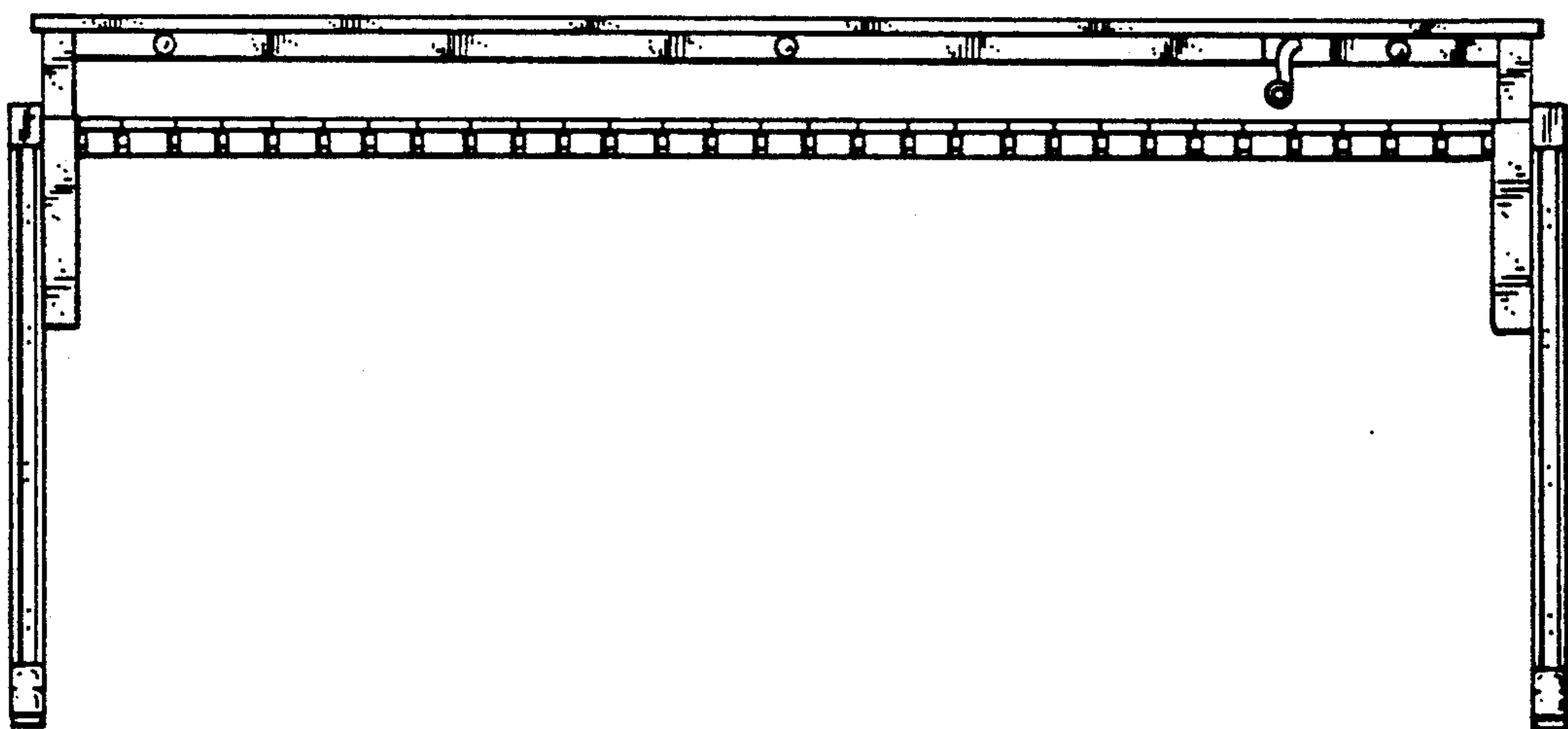

FIG. 3

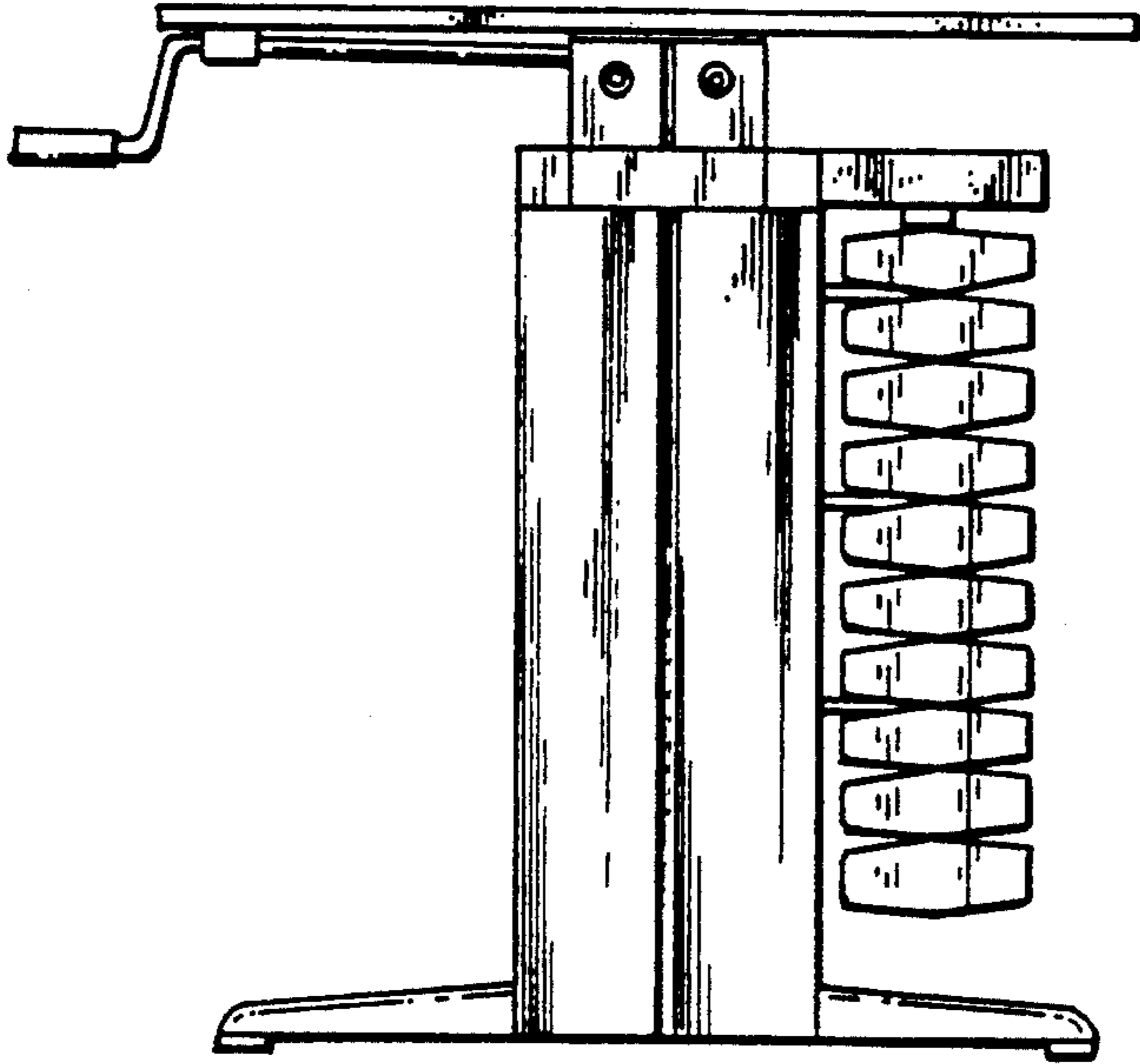

FIG. 4

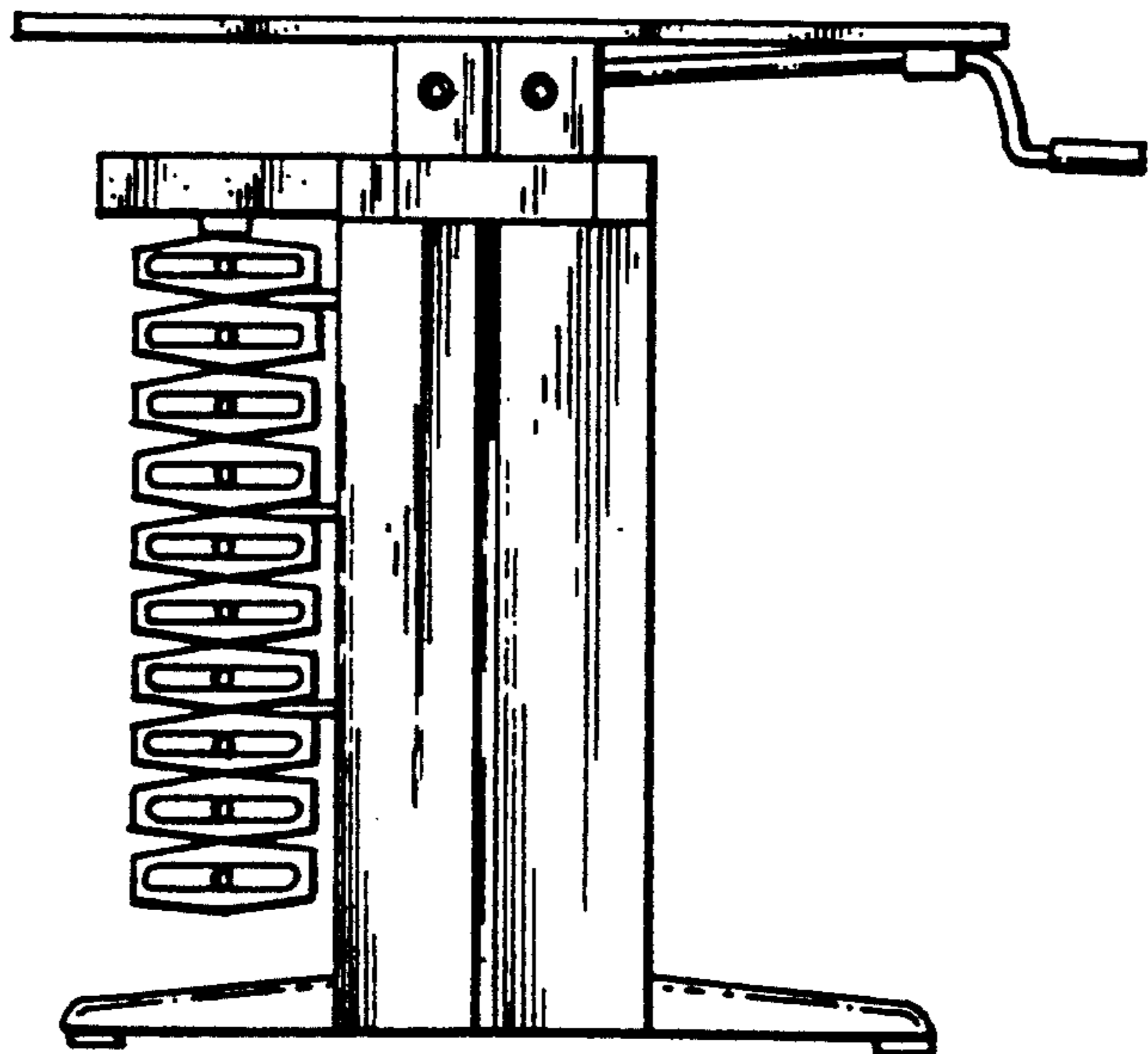

FIG. 5

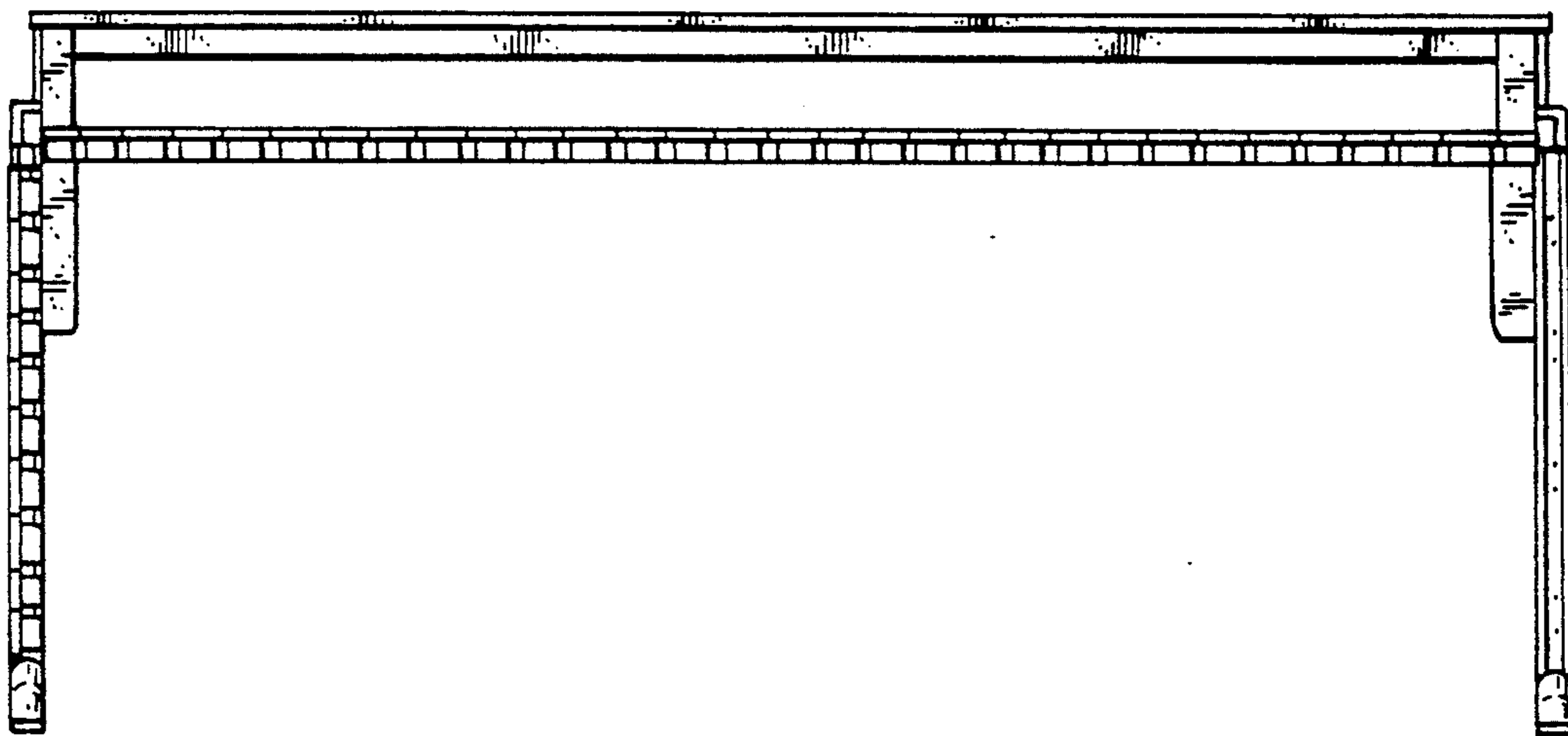
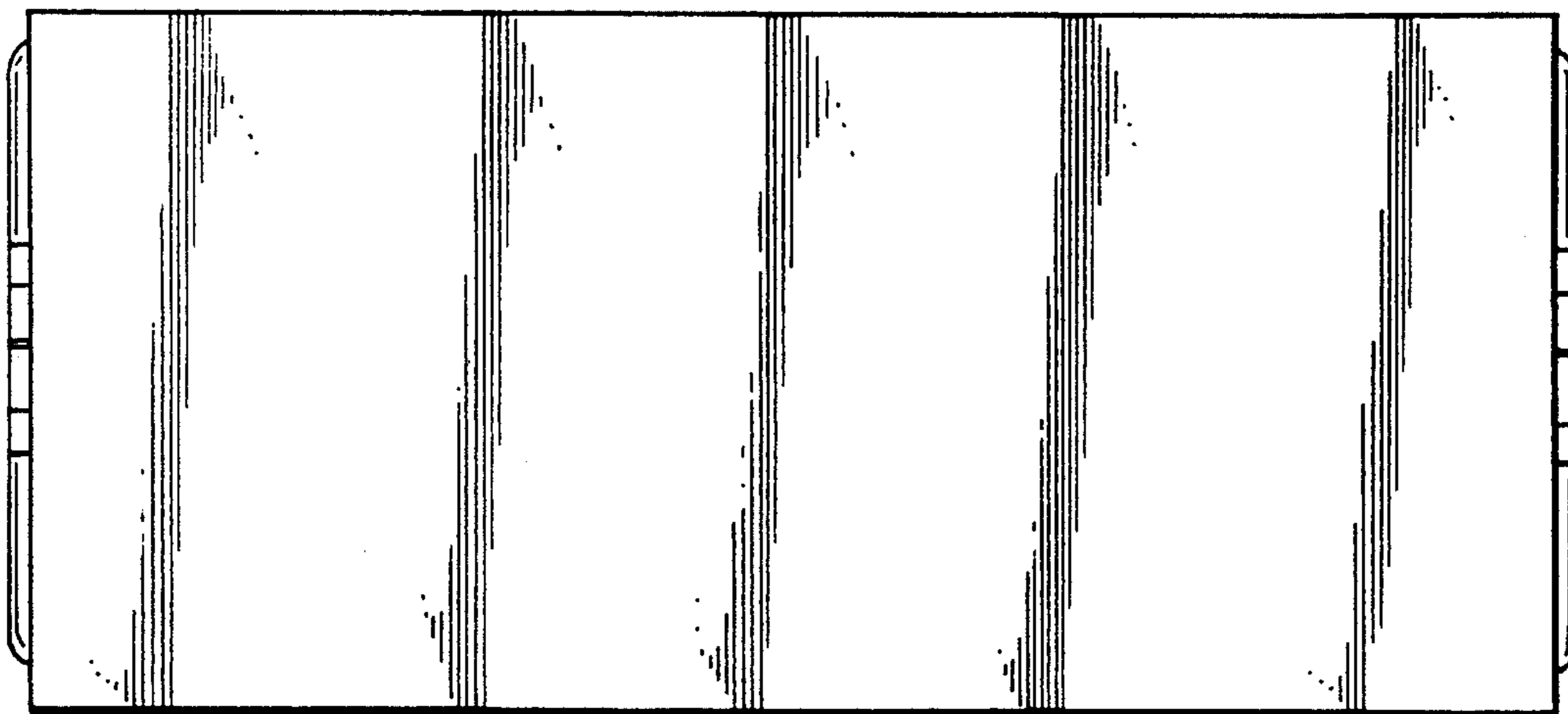

FIG. 6



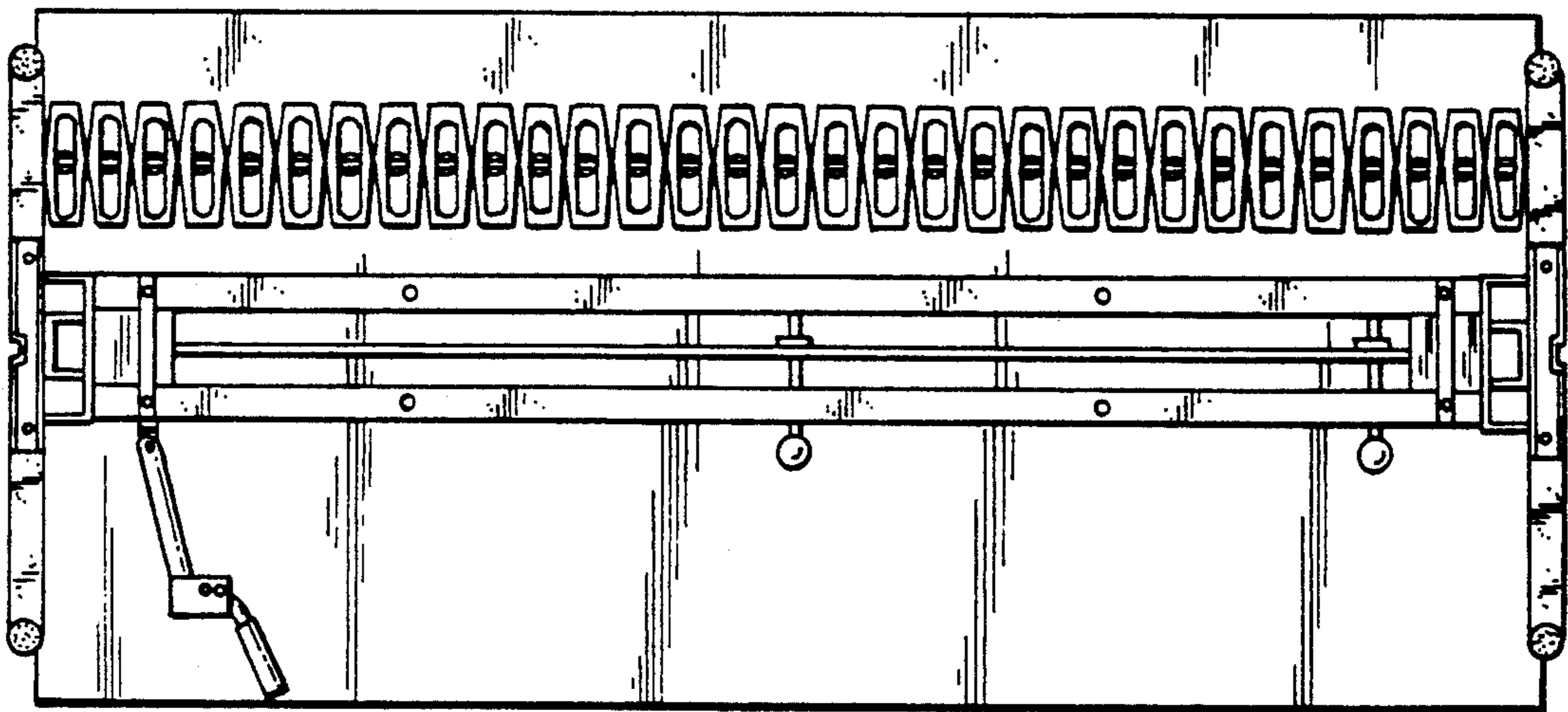

FIG. 7