



US00D337210S

United States Patent [19]

[11] Patent Number: **Des. 337,210**

Silverman

[45] Date of Patent: **** Jul. 13, 1993**

- [54] **CHILD'S BOOSTER SEAT**
- [75] Inventor: **Matthew H. Silverman**, Concord, Mass.
- [73] Assignee: **Downunder Design Inc.**, Concord, Mass.
- [**] Term: **14 Years**
- [21] Appl. No.: **518,644**
- [22] Filed: **May 2, 1990**
- [52] U.S. Cl. **D6/333**
- [58] Field of Search **D6/333, 334, 335; 297/181, 250**

- 4,770,468 9/1988 Shubin D6/333
- 4,915,446 4/1990 Darling et al. 297/250

FOREIGN PATENT DOCUMENTS

- 197910 10/1986 European Pat. Off. 297/250
- 2154131 9/1985 United Kingdom 297/250

Primary Examiner—Nelson C. Holtje
Assistant Examiner—Monica A. Hannon
Attorney, Agent, or Firm—Salzman & Levy

[57] CLAIM

The ornamental design for a child's booster seat, as shown and described.

DESCRIPTION

FIG. 1 is a front perspective view of a child's booster seat showing the new design;
 FIG. 2 is a bottom perspective view thereof;
 FIG. 3 is a front elevational view thereof;
 FIG. 4 is a top plan view thereof;
 FIG. 5 is a rear elevational view thereof; and,
 FIG. 6 is a right side elevational view, the left side being a mirror image thereof.
 FIGS. 2 through 6 have been drawn on an enlarged scale with respect to FIG. 1.

[56] **References Cited**
U.S. PATENT DOCUMENTS

- D. 151,417 10/1948 Syerdlik D6/335
- D. 264,788 6/1972 Blanchard D6/333
- D. 266,044 9/1982 Blanchard D6/333 X
- D. 286,586 11/1986 Radford D6/334
- D. 297,684 9/1988 Taylor, Sr. D6/335
- D. 301,188 5/1989 Casale D6/335
- 4,092,049 5/1978 Schoblom D6/334 X
- 4,440,331 4/1984 Schimmels 297/250 X
- 4,711,490 12/1987 Brand 297/250

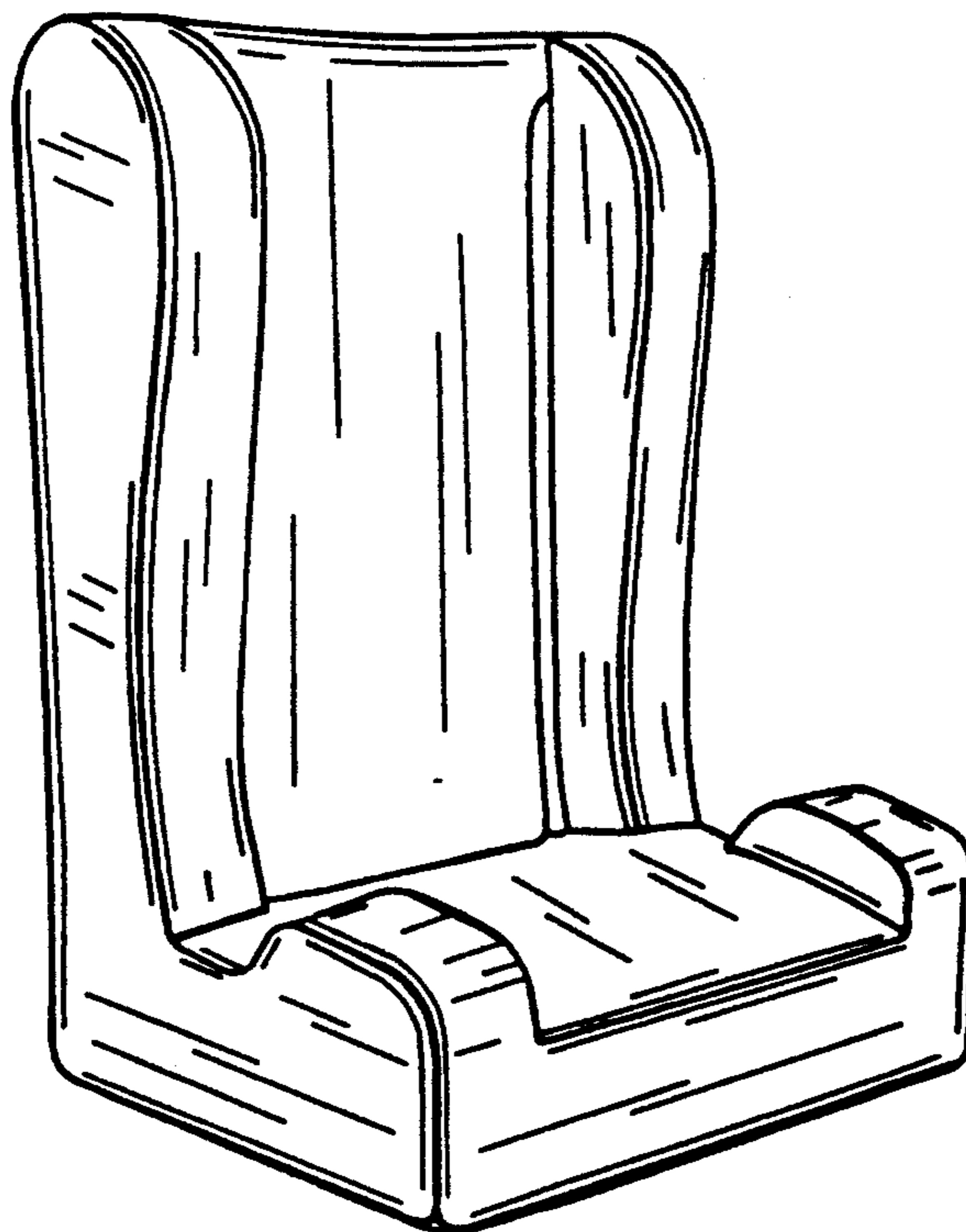

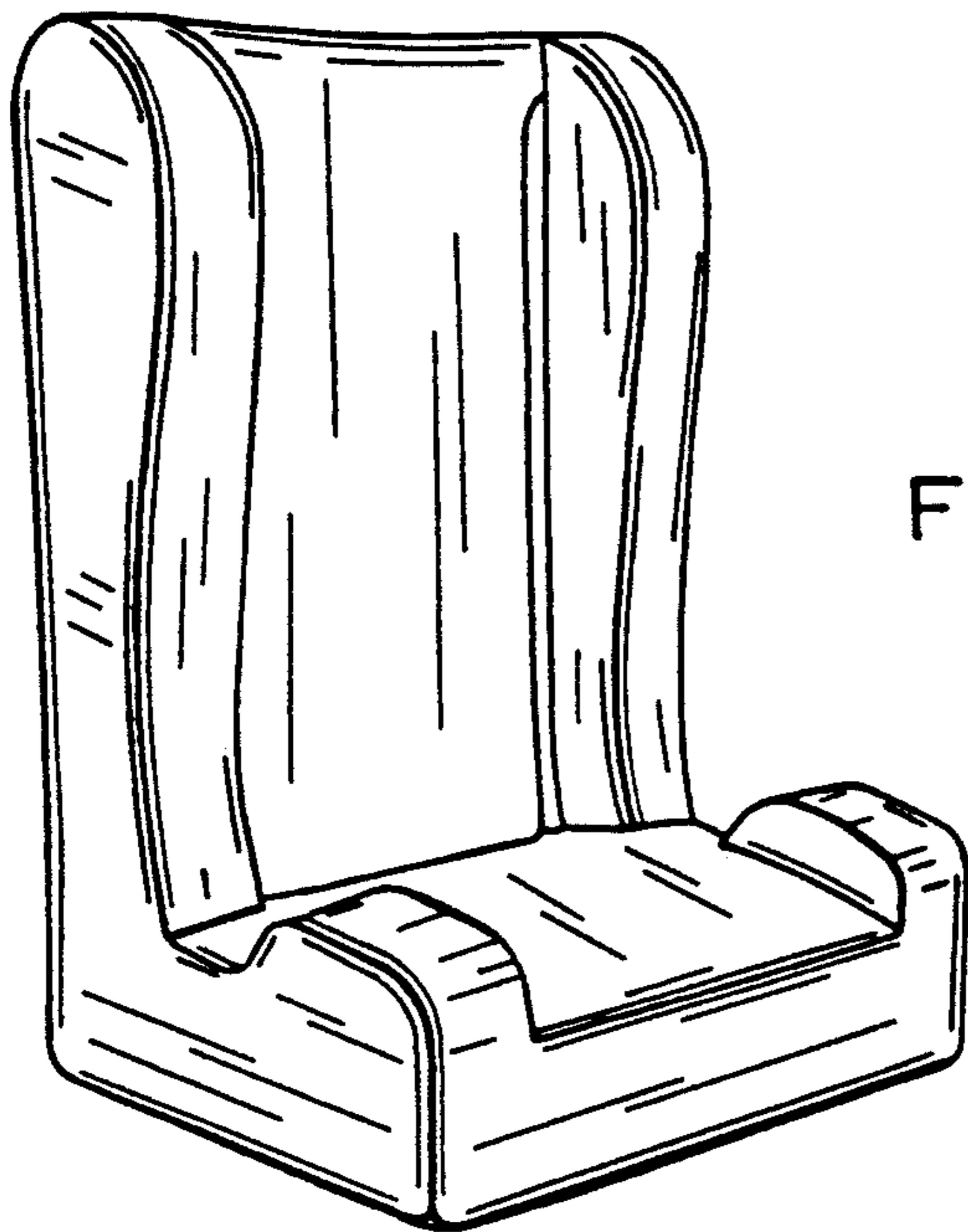

FIG. 1

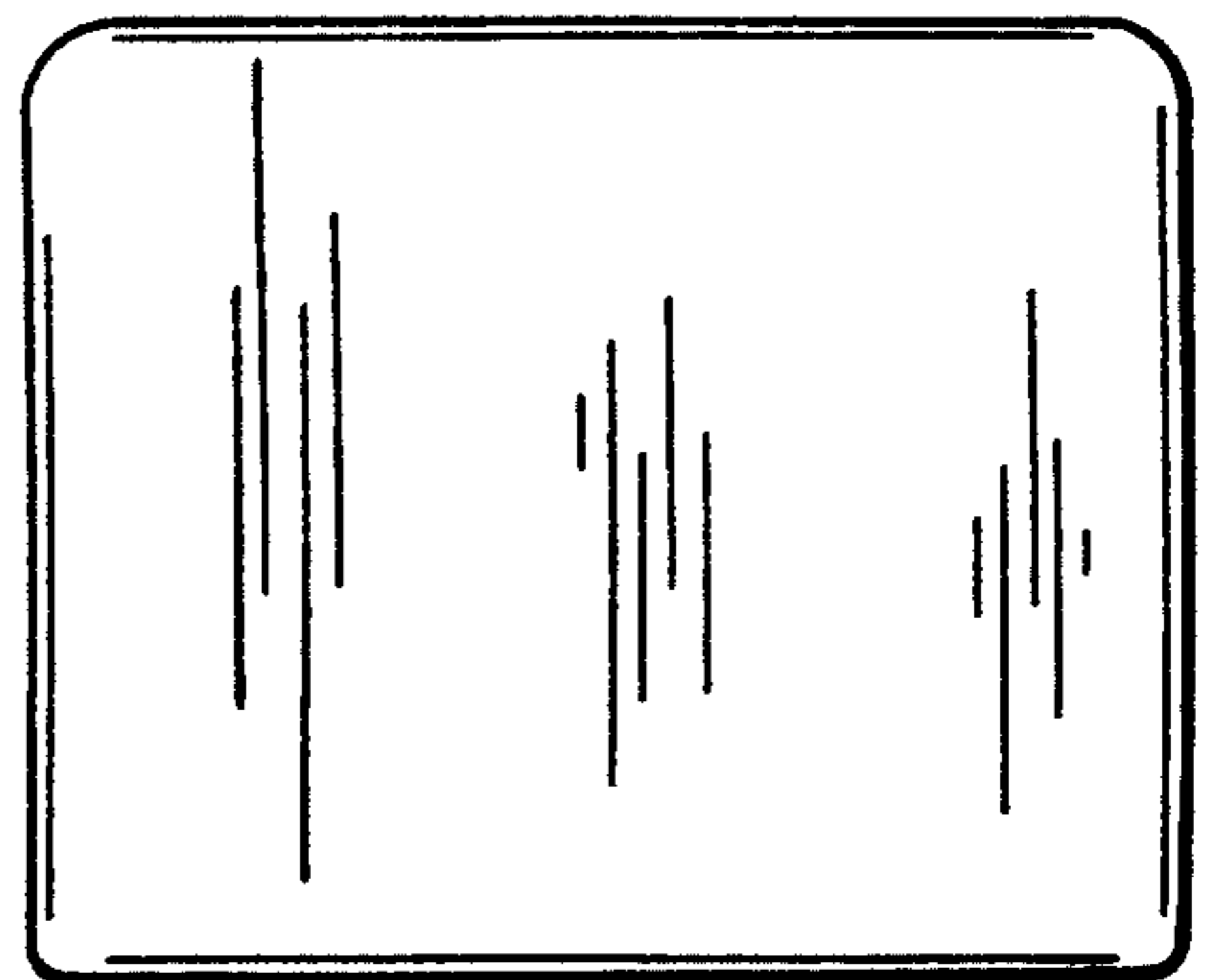

FIG. 2

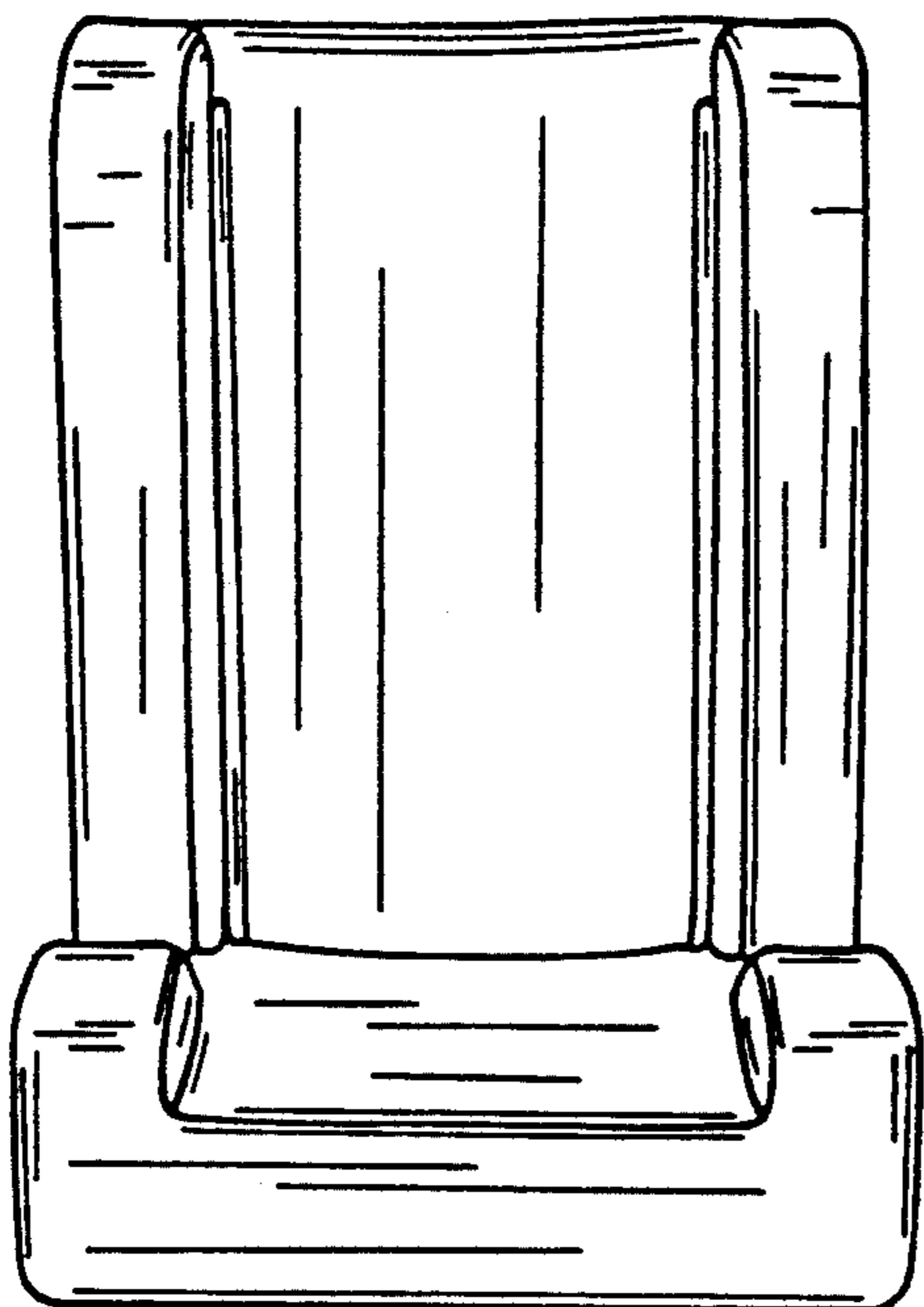

FIG. 3

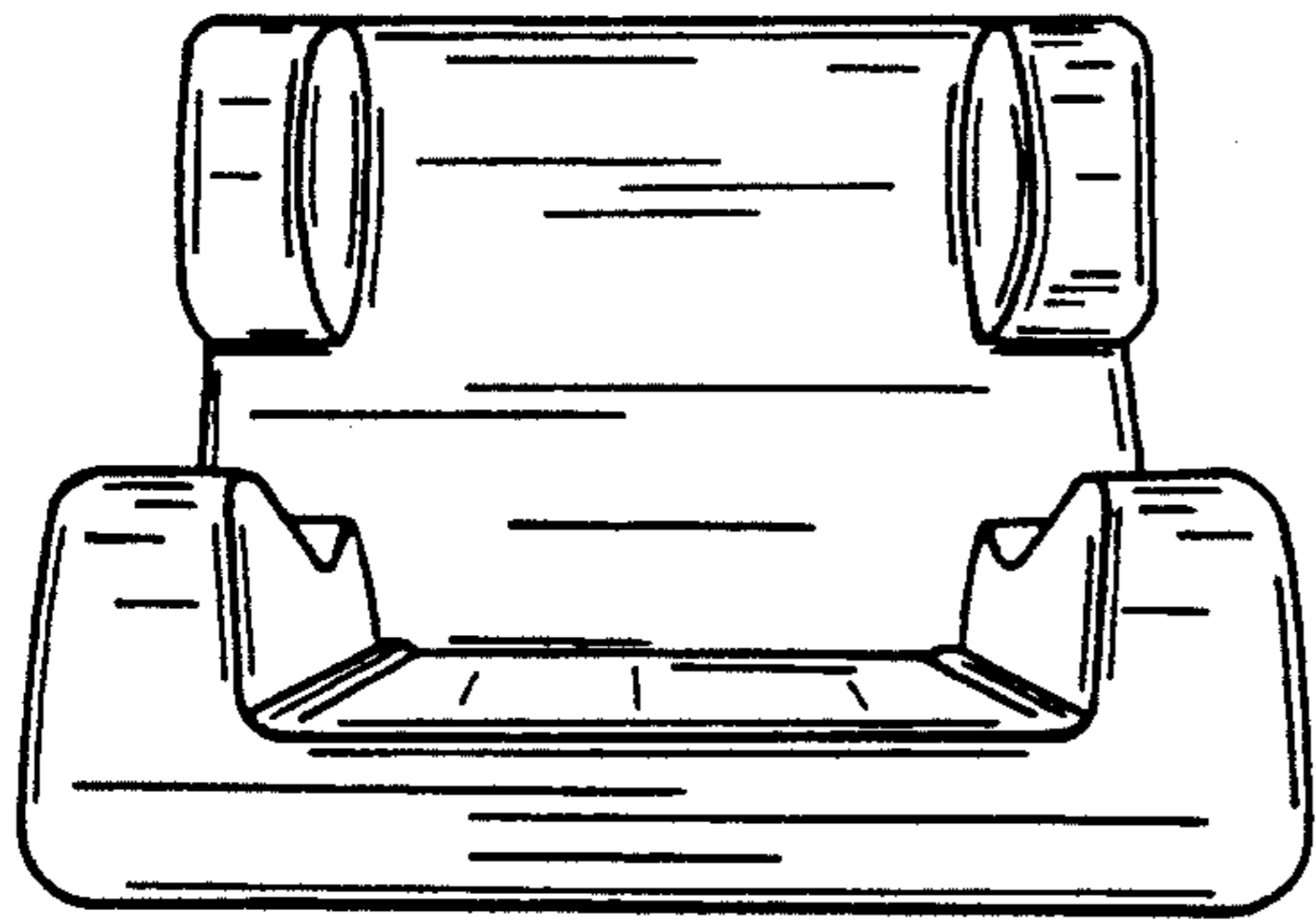

FIG. 4

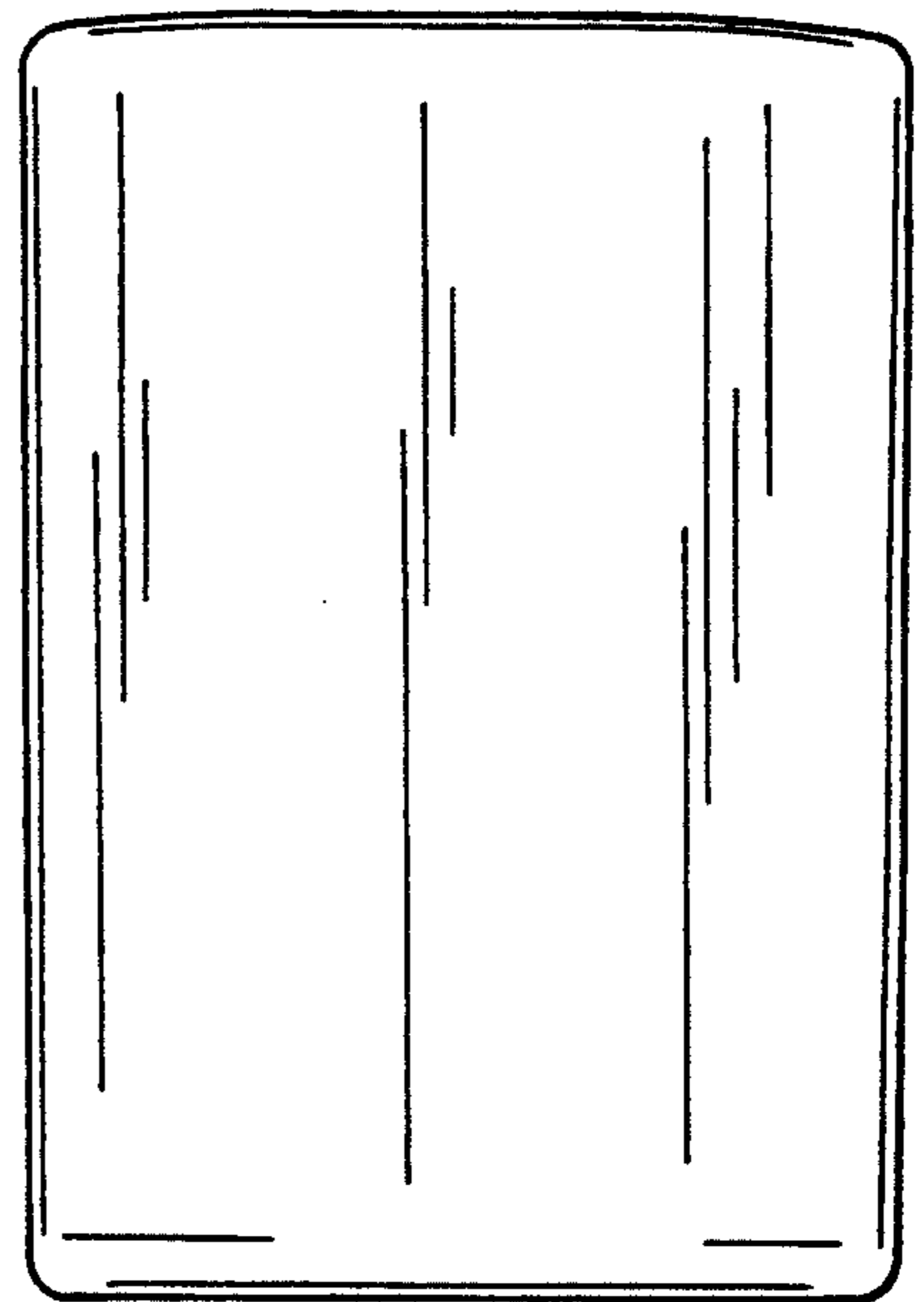

FIG. 5

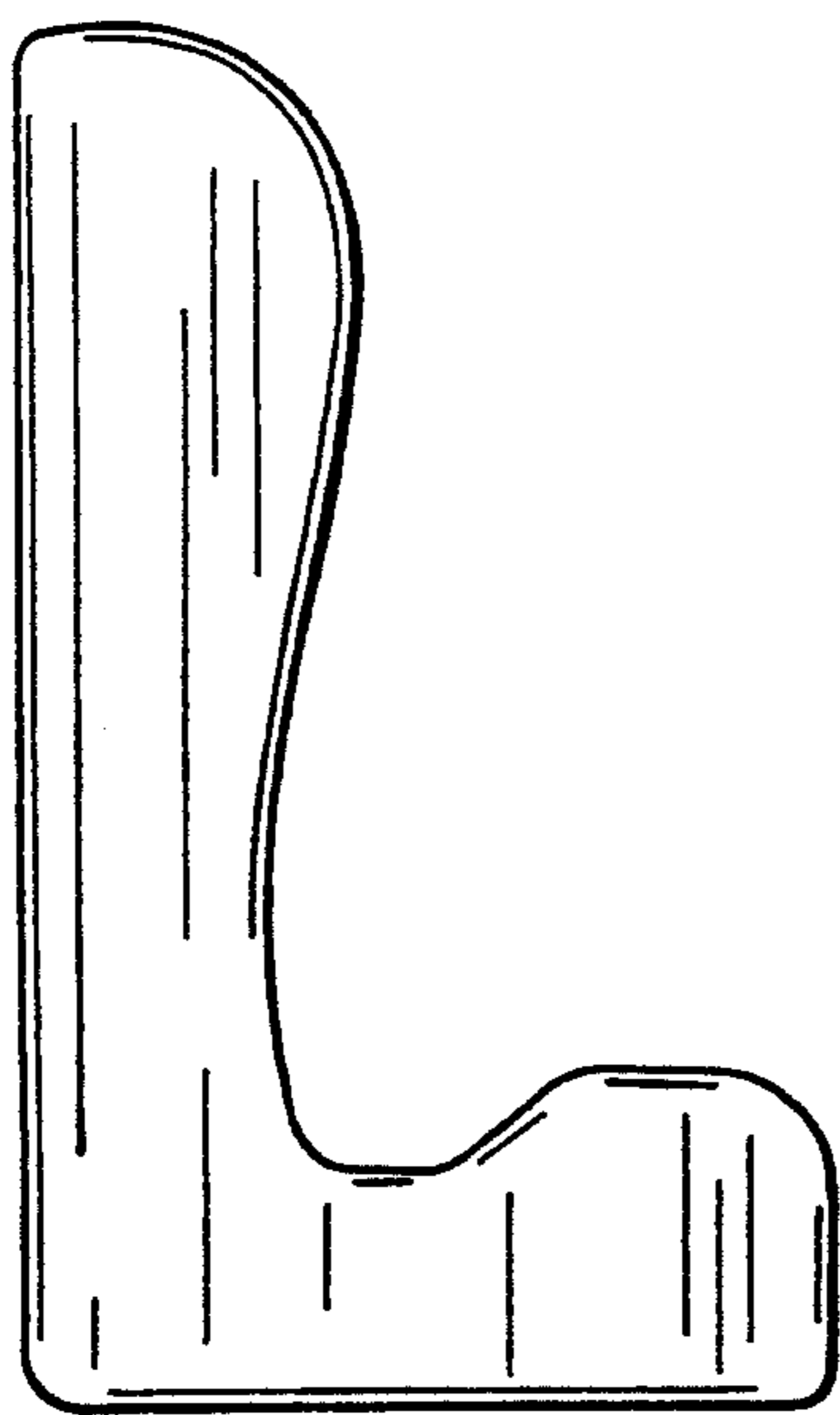

FIG. 6