



US00D337155S

United States Patent [19] O'Connell

[11] Patent Number: **Des. 337,155**
[45] Date of Patent: **** Jul. 6, 1993**

- [54] SINK
- [75] Inventor: **David J. O'Connell**, Sturgeon Bay, Wis.
- [73] Assignee: **Kohler Co.**, Kohler, Wis.
- [**] Term: **14 Years**
- [21] Appl. No.: **639,955**
- [22] Filed: **Jan. 11, 1991**
- [52] U.S. Cl. **D23/284**
- [58] Field of Search **D23/271-275, D23/284-294; 4/580, 619, 630-636, 639, 640, 642, 650-660, DIG. 18**

[56] **References Cited**

U.S. PATENT DOCUMENTS

D. 113,232	2/1939	Love	D23/294
D. 198,305	6/1964	Graning, Jr.	D23/290
D. 218,606	9/1970	Lien	D23/287
D. 226,378	2/1973	Doman	D23/290
D. 234,199	1/1975	Stairs, Jr.	D23/294
D. 234,427	3/1975	Stairs, Jr.	D23/294
D. 326,902	6/1992	Bonnell	D23/284
434,402	8/1890	Putnam	4/651
440,211	11/1890	Weeden	4/651
580,136	4/1897	Lloyd	4/651
4,336,620	6/1982	Gresh	4/619.8 R

OTHER PUBLICATIONS

Jacob Delafon Drawing and Ad Showing the Keyhole Shaped Basins, undated, admitted prior art.
An ad showing the "Laredo" tub, undated, admitted prior art.
A drawing of a Sterling Sink, undated, admitted prior art.

Primary Examiner—James R. Largen

Attorney, Agent, or Firm—Quarles & Brady

[57] CLAIM

The ornamental design for a sink, as shown and described.

DESCRIPTION

FIG. 1 is a perspective view taken from the top, front and right side of a sink showing my new design;
FIG. 2 is a top plan view thereof;
FIG. 3 is a cross-sectional view taken on line 3—3 of FIG. 2;
FIG. 4 is a cross-sectional view taken on line 4—4 of FIG. 2;
FIG. 5 is a cross-sectional view taken on line 5—5 of FIG. 2;
FIG. 6 is a cross-sectional view taken on line 6—6 of FIG. 2;
FIG. 7 is a perspective view taken from the top, front and right side of a second embodiment thereof;
FIG. 8 is a top plan view thereof;
FIG. 9 is a cross-sectional view taken on line 9—9 of FIG. 8;
FIG. 10 is a cross-sectional view taken on line 10—10 of FIG. 8;
FIG. 11 is a cross-sectional view taken on line 11—11 of FIG. 8;
FIG. 12 is a cross sectional view taken on line 12—12 of FIG. 8;
FIG. 13 is a top plan view of a third embodiment thereof; and,
FIG. 14 is a top plan view of a forth embodiment thereof.

The fragmentary broken line representation of counter tops in FIGS. 1, 6, 7 and 12 the broken line representations of fitting mounting holes in FIGS. 13 and 14 are for purposes of illustration only and form no part of the claimed design.

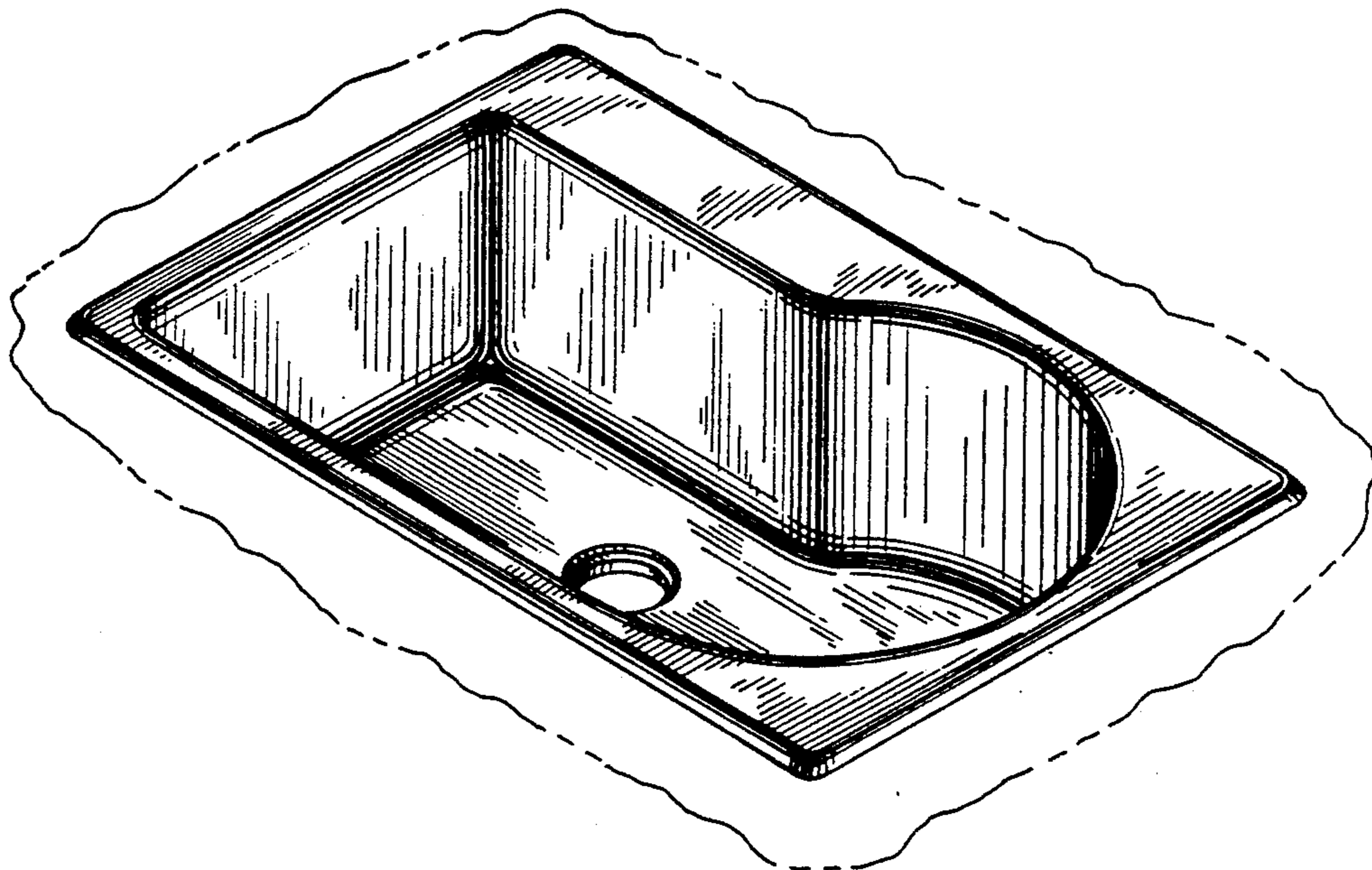

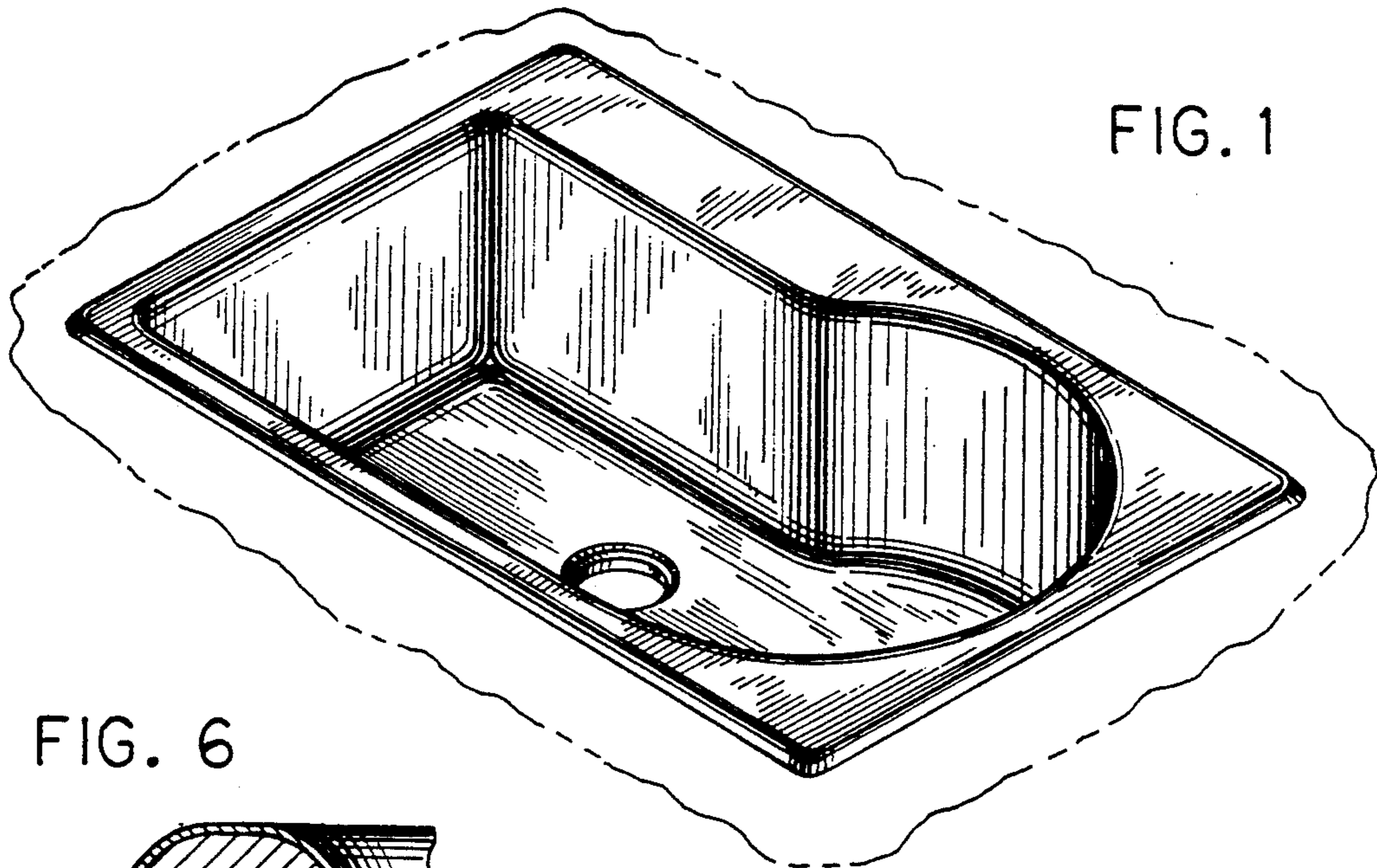

FIG. 6

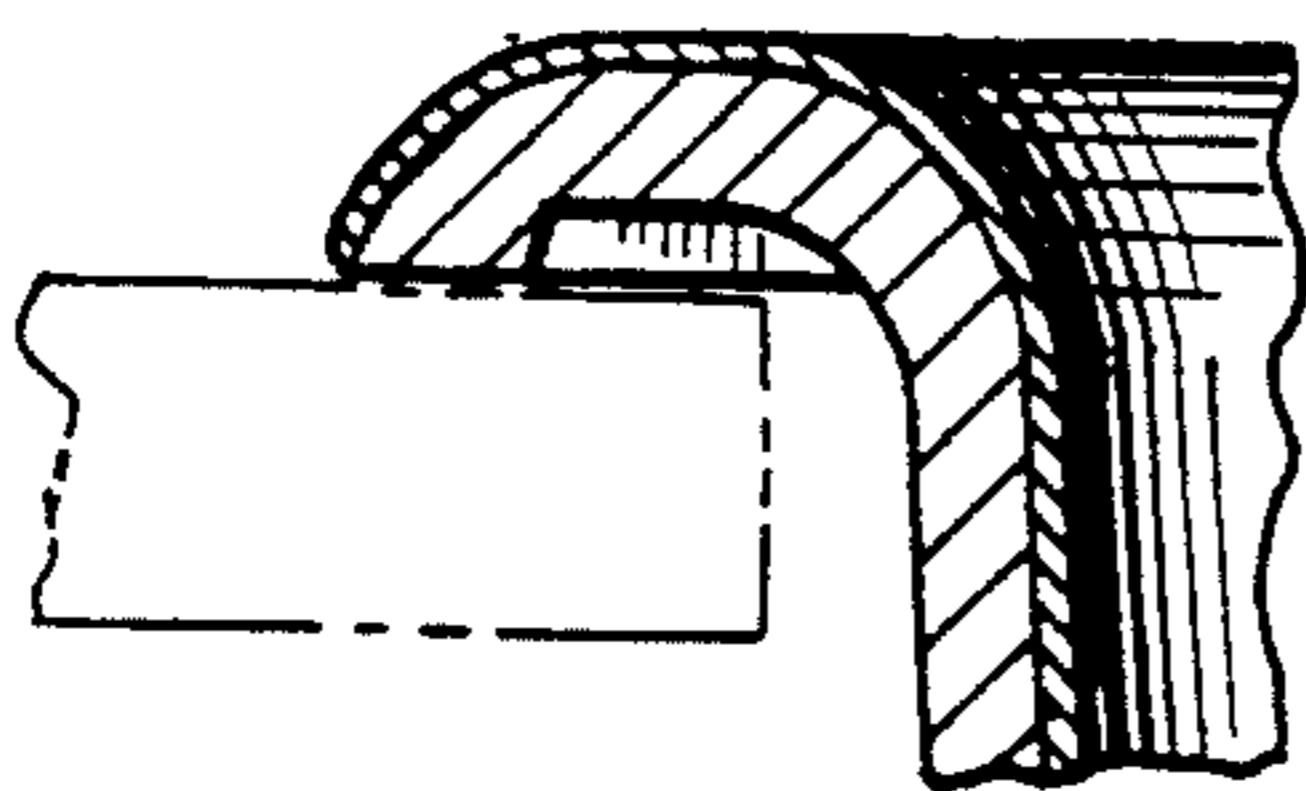

FIG. 2

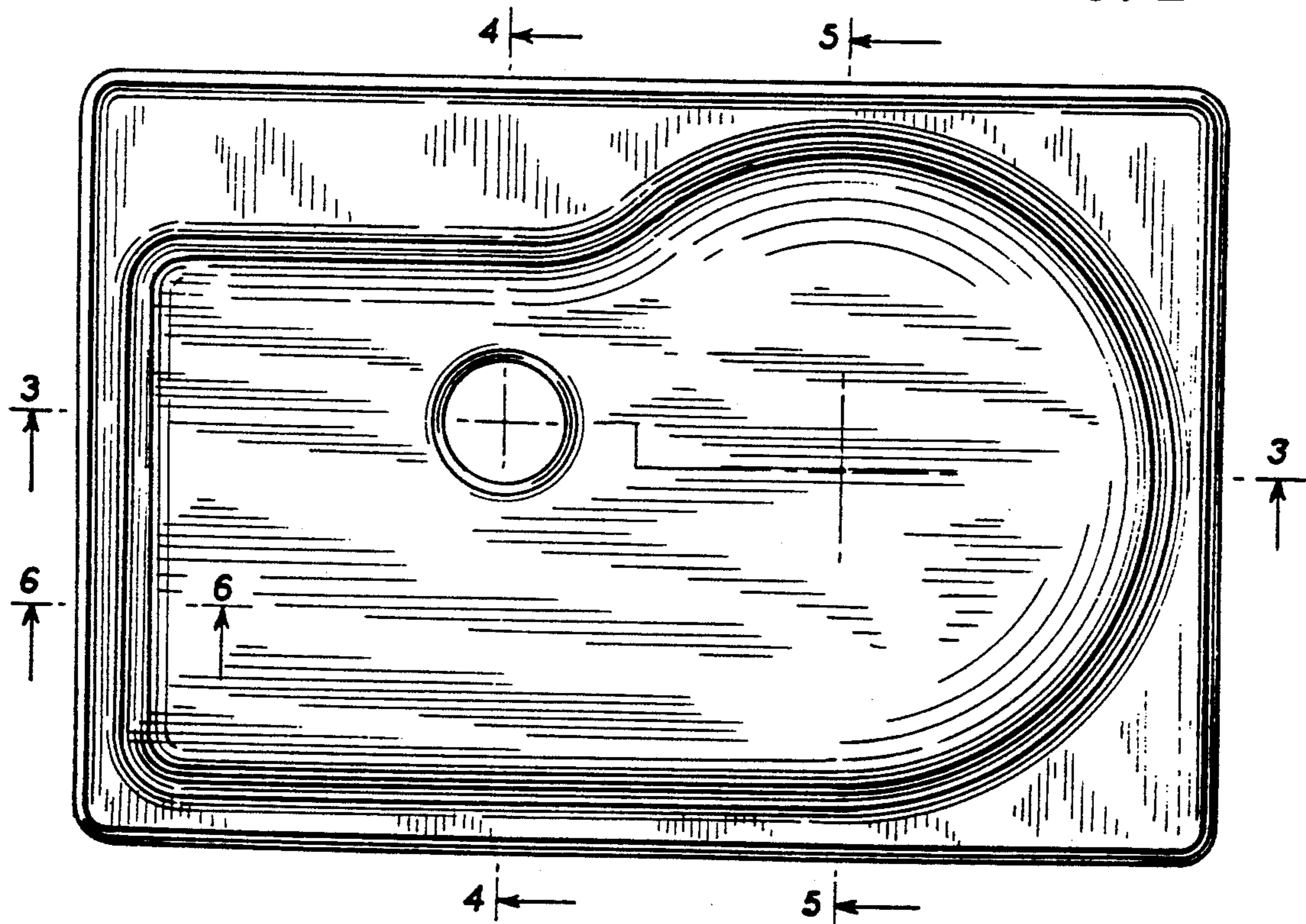

FIG. 3

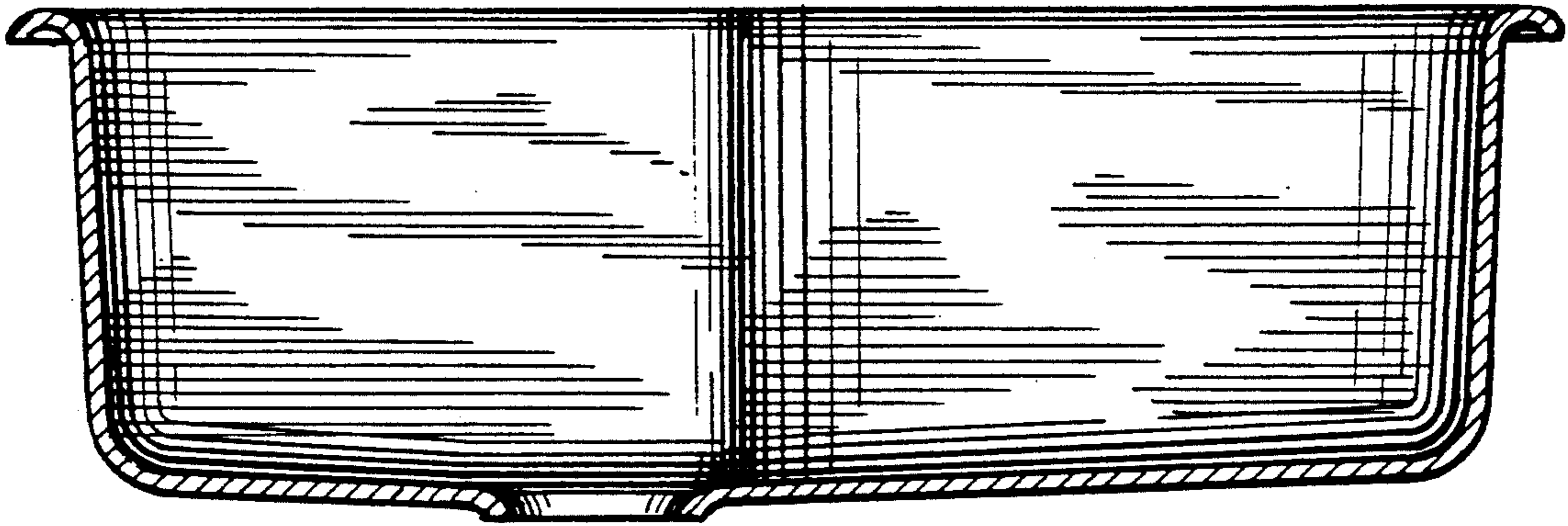

FIG. 4

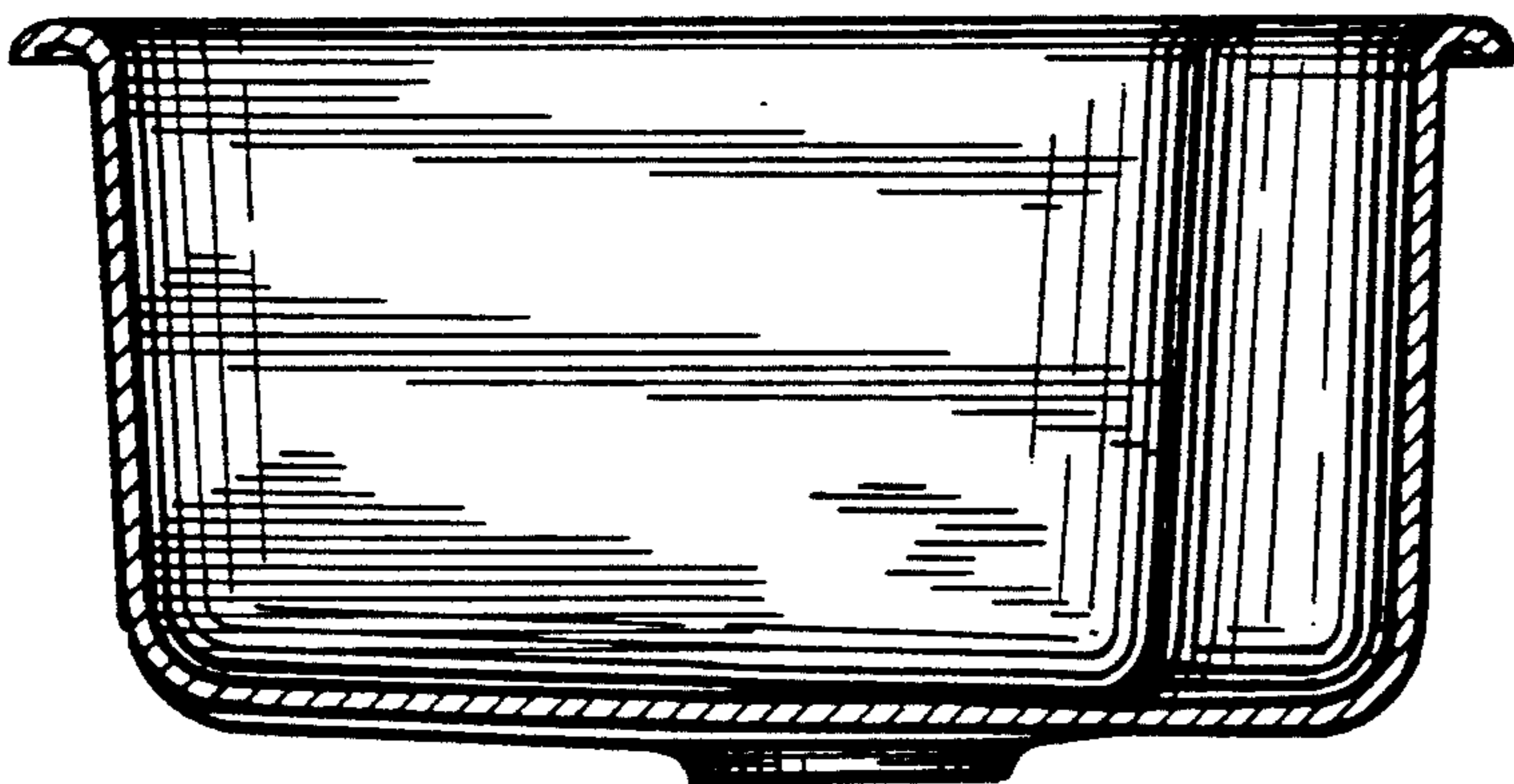
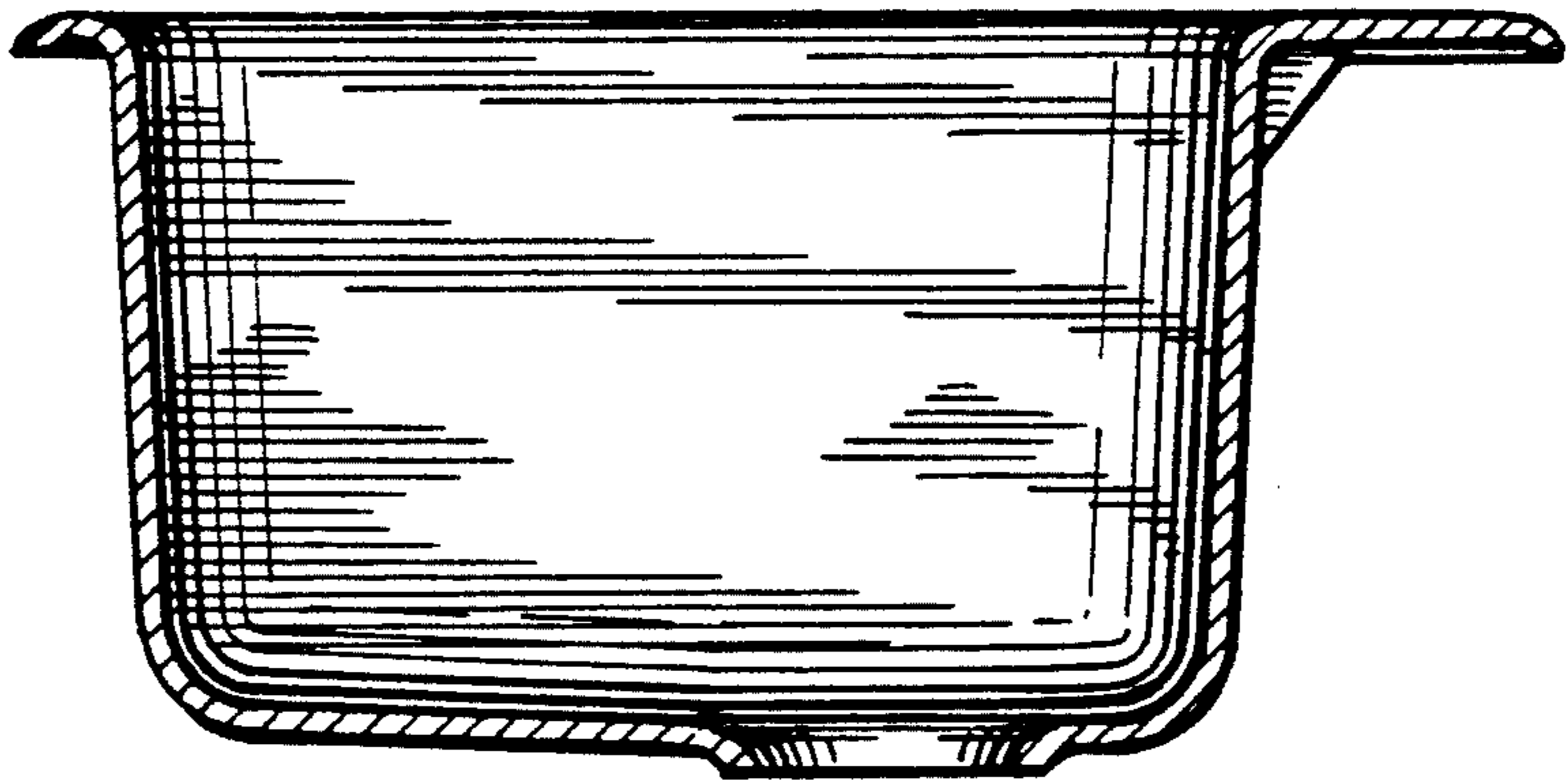

FIG. 5

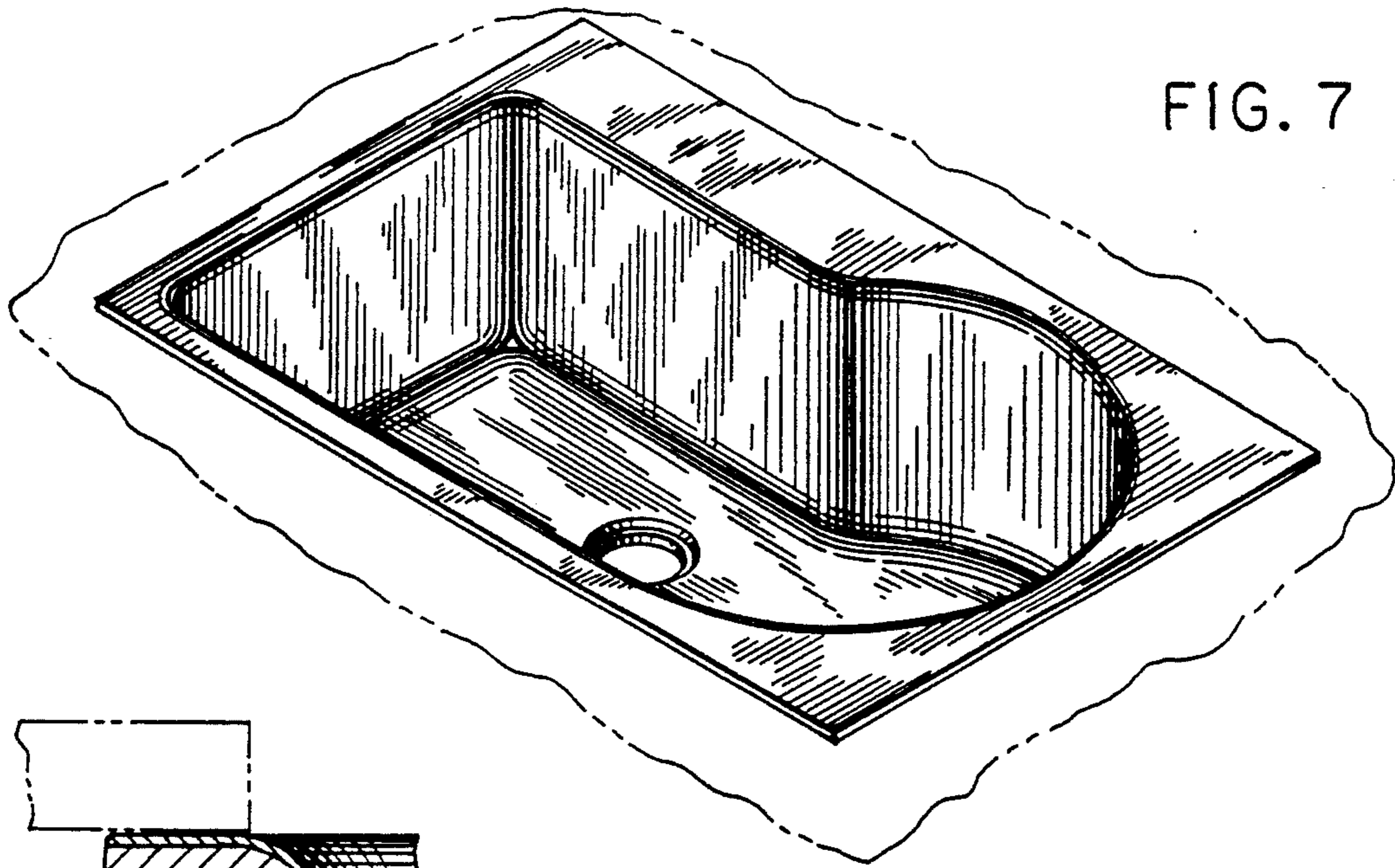

FIG. 7

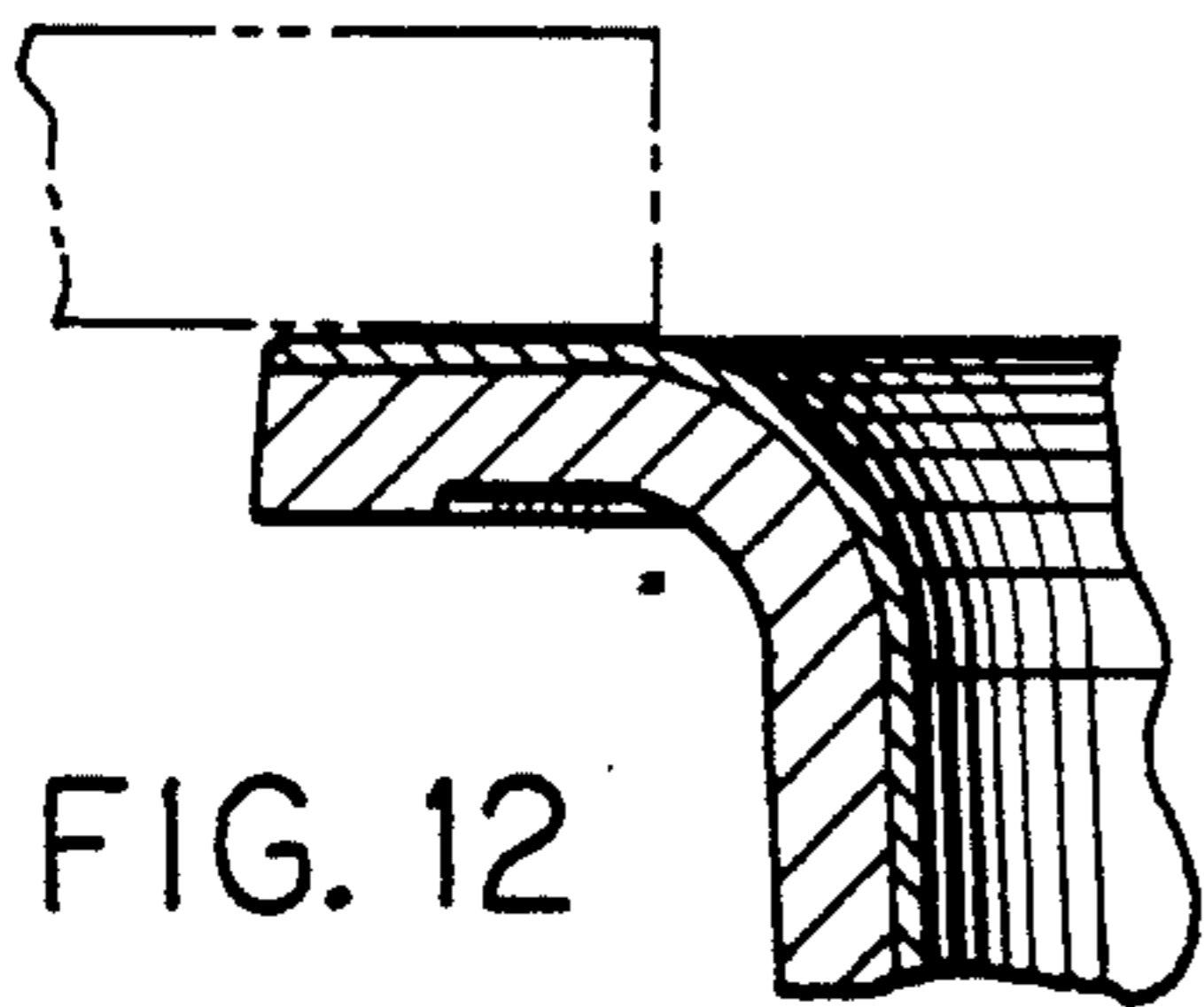

FIG. 12

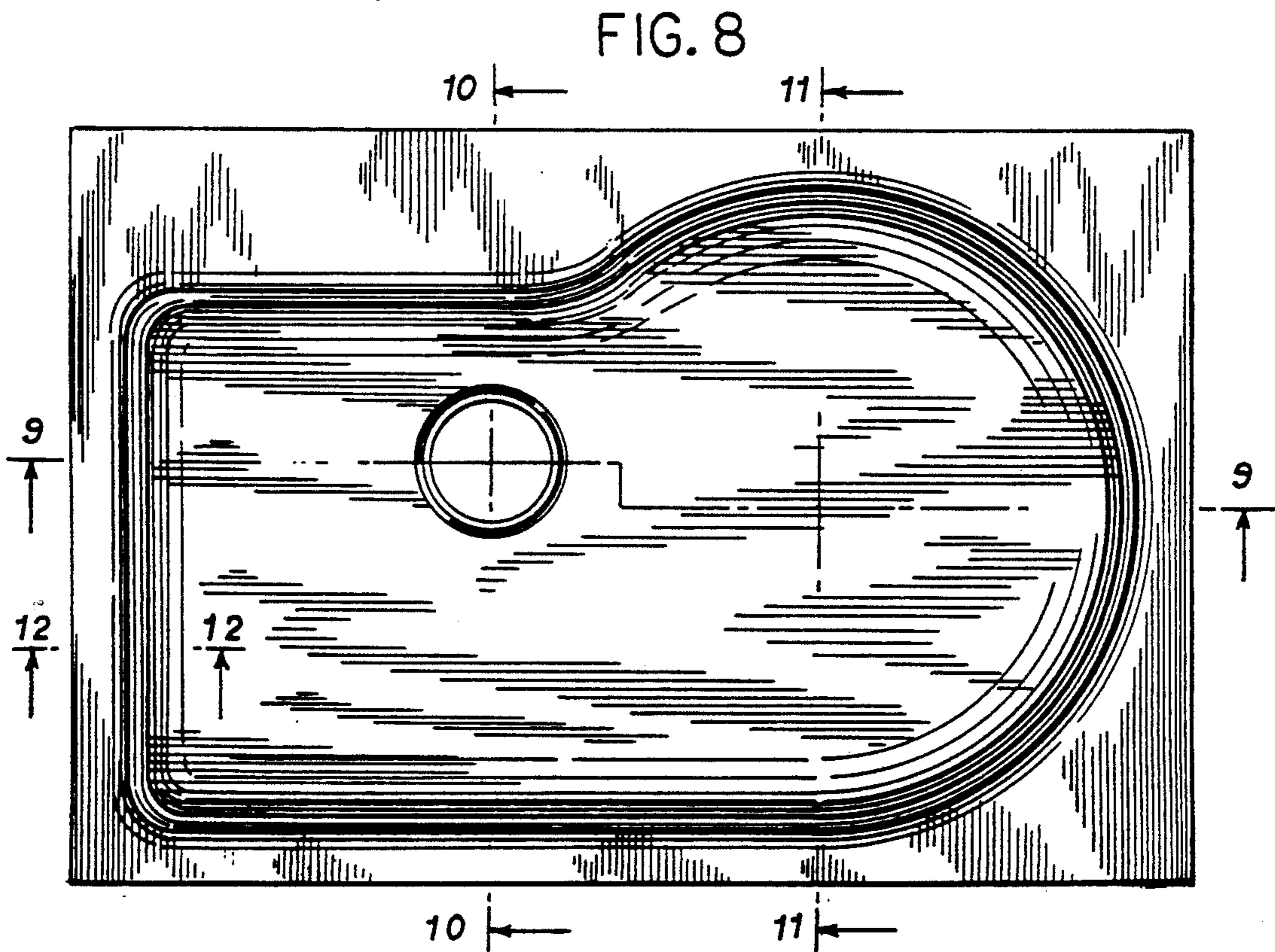

FIG. 8

FIG. 9

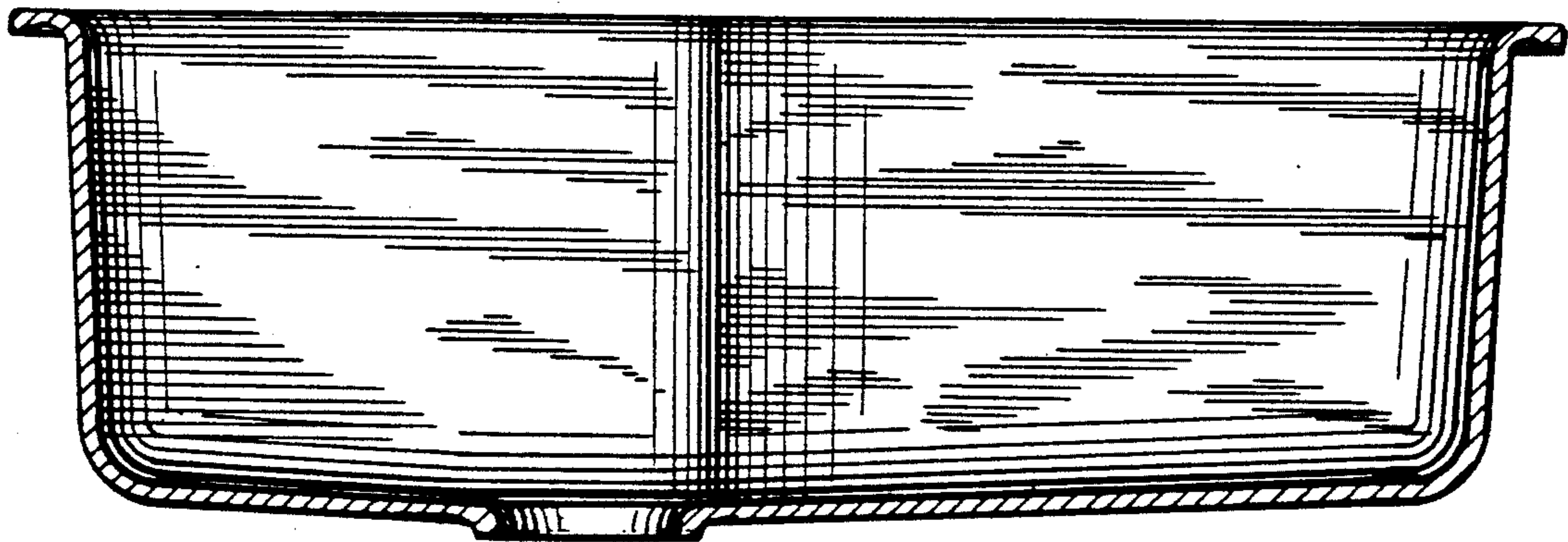

FIG. 10

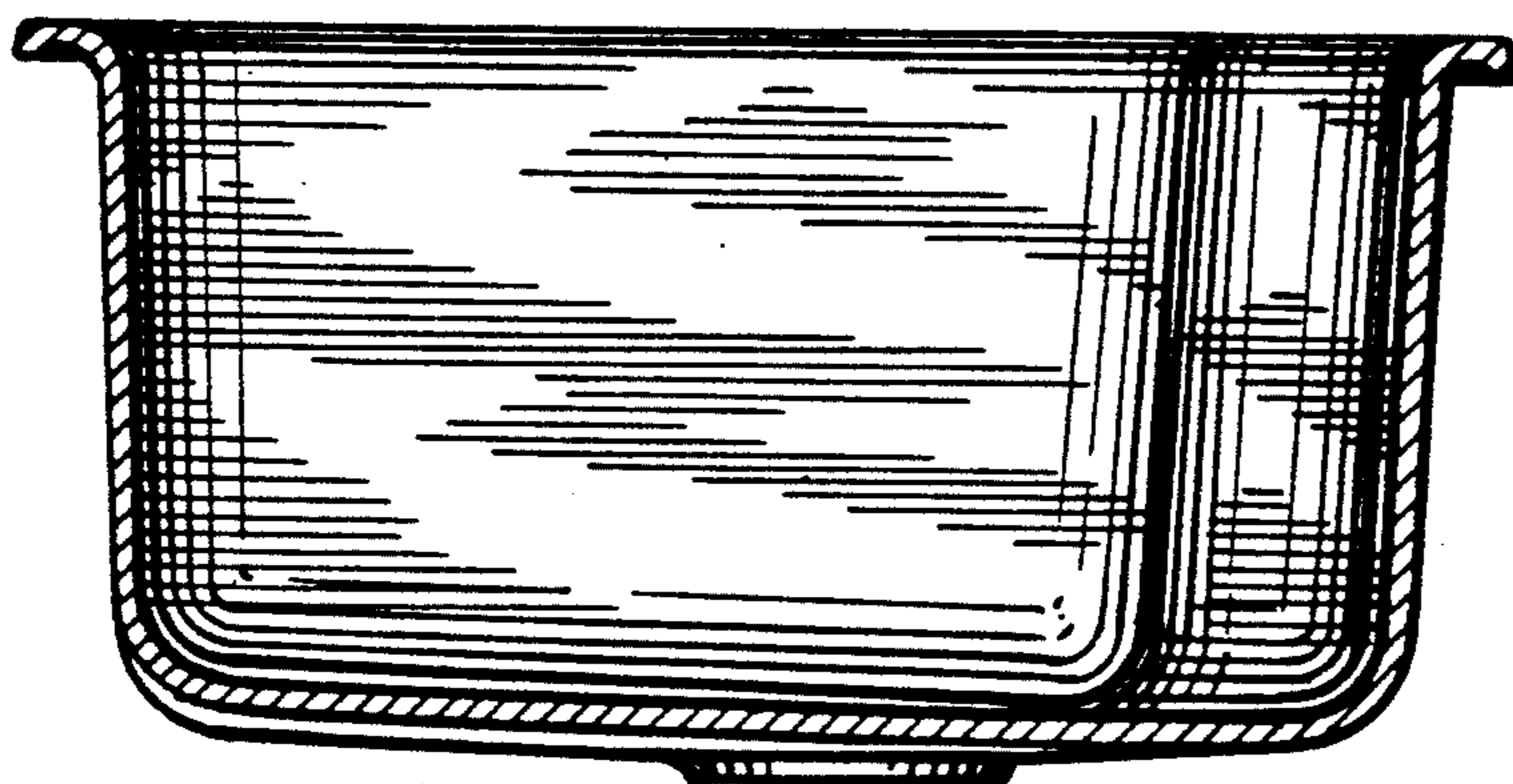
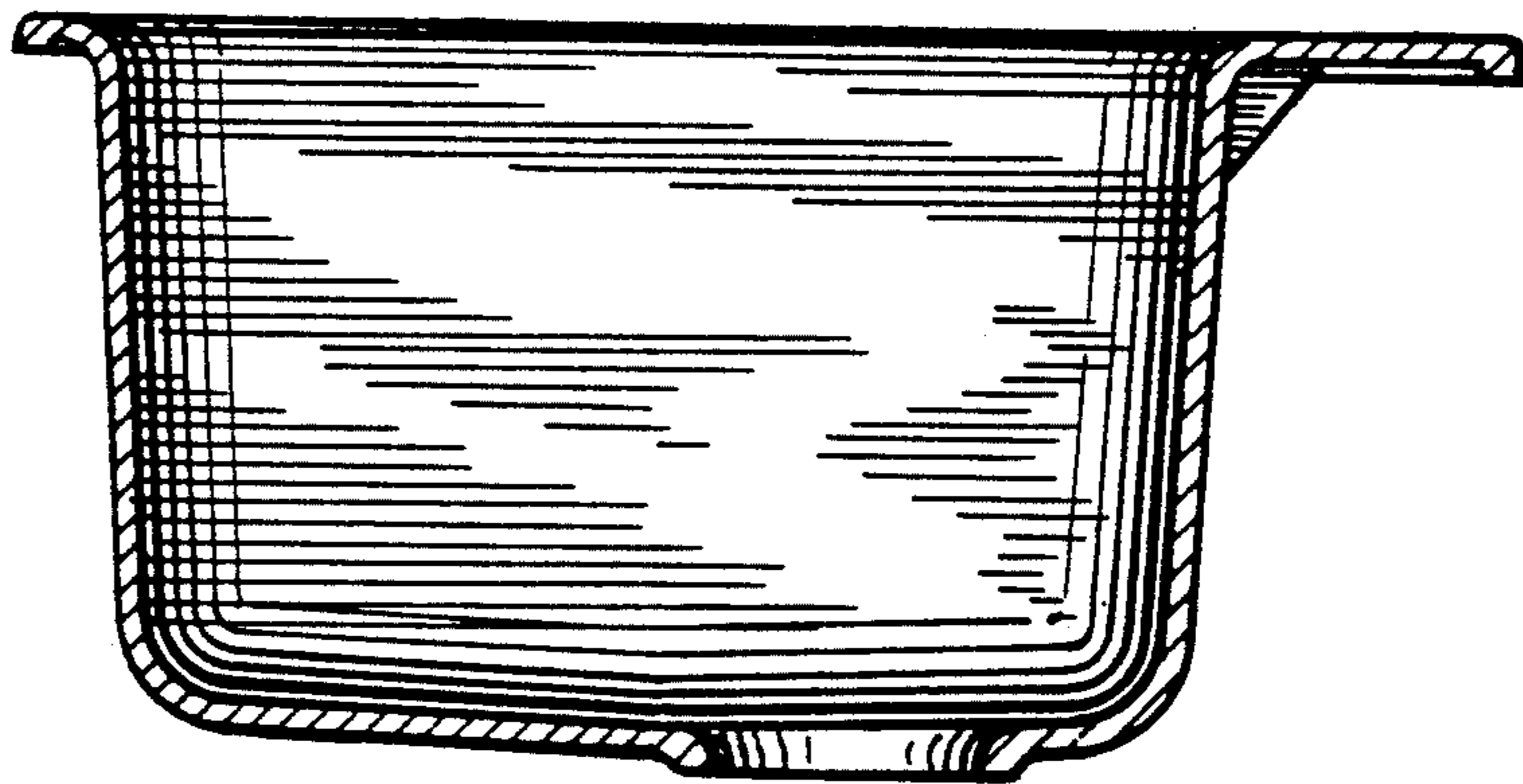

FIG. 11

FIG. 13

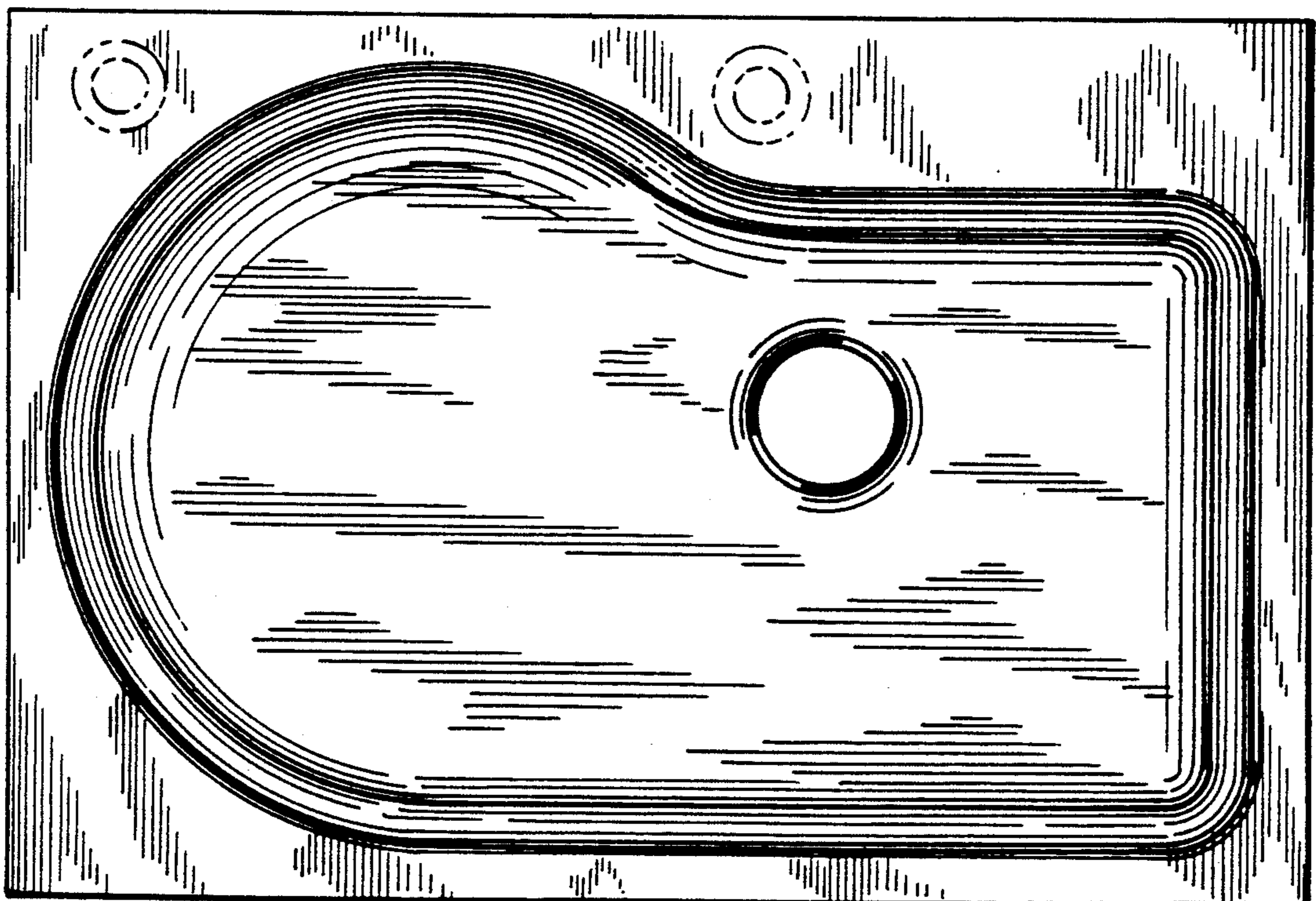
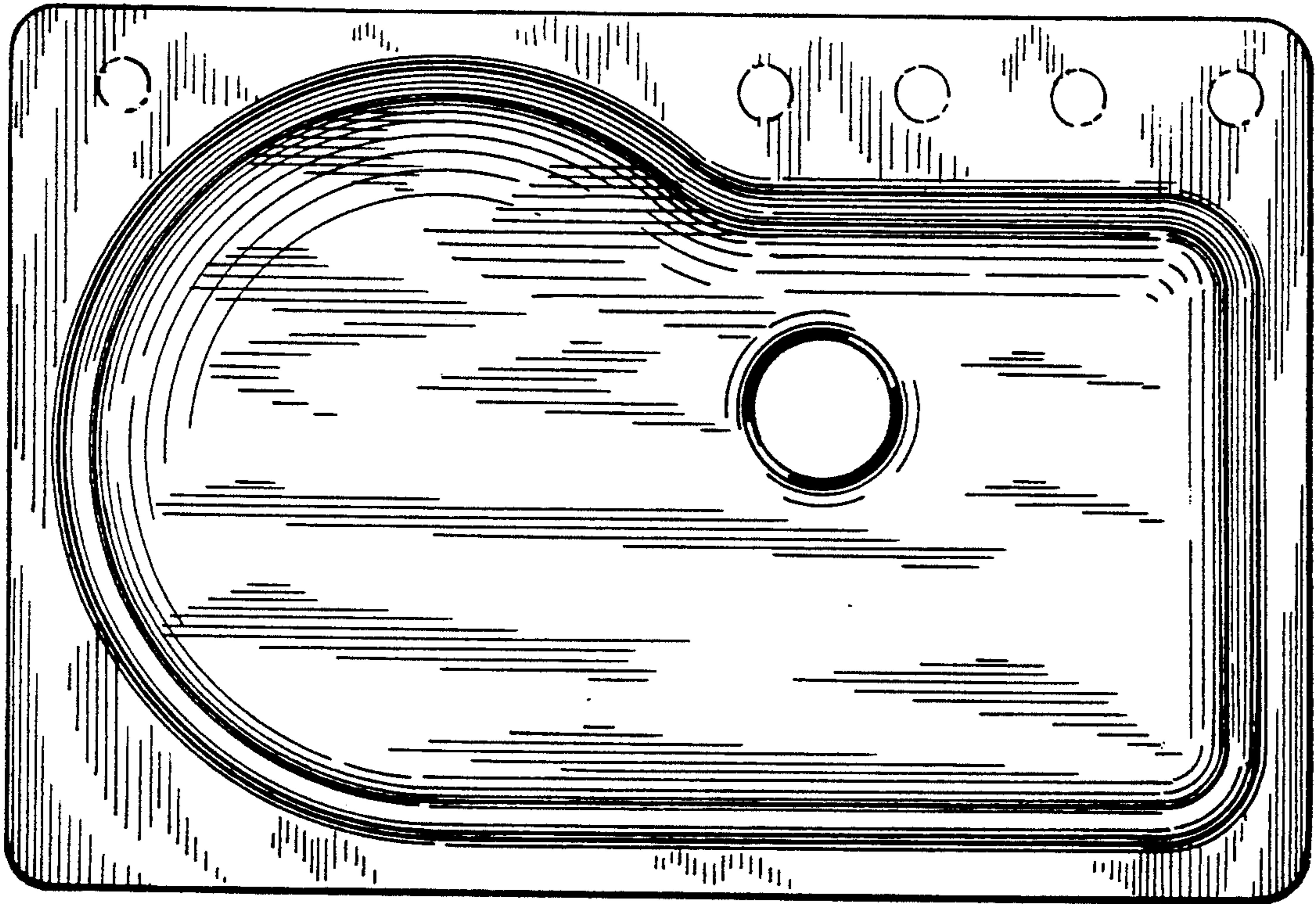

FIG. 14