



US00D337110S

# United States Patent [19]

[11] Patent Number: **Des. 337,110**

**Nakaizumi**

[45] Date of Patent: **\*\* Jul. 6, 1993**

[54] **MAGNETIC TAPE CASSETTE FOR VIDEO**

D. 304,583 11/1989 Nakaizumi ..... D14/121  
D. 330,374 10/1992 Itakura et al. .... D14/121

[75] Inventor: **Hiroshi Nakaizumi, Tokyo, Japan**

*Primary Examiner*—Theodore M. Shooman  
*Attorney, Agent, or Firm*—Lewis H. Eslinger; Jay H. Maioli

[73] Assignee: **Sony Corporation, Tokyo, Japan**

[\*\*] Term: **14 Years**

### [57] CLAIM

[21] Appl. No.: **657,315**

The ornamental design for a magnetic tape cassette for video, as shown.

[22] Filed: **Feb. 15, 1991**

### [30] Foreign Application Priority Data

### DESCRIPTION

Aug. 15, 1990 [JP] Japan ..... 2-27615

FIG. 1 is a top, front and right-side perspective view of a magnetic tape cassette for video showing my new design;

[52] U.S. Cl. .... **D14/121**

FIG. 2 is a bottom, front, and left-side perspective view thereof;

[58] Field of Search ..... D14/114, 120-122,  
D14/299; 242/55.19 A, 197-200; 273/DIG. 28,  
85 G

FIG. 3 is a front elevational view thereof;

### [56] References Cited

#### U.S. PATENT DOCUMENTS

D. 271,392 11/1983 Sumisha et al. .... D14/121  
D. 304,582 11/1989 Nakaizumi ..... D14/121

FIG. 4 is a rear elevational view thereof;

FIG. 5 is a left-side elevational view thereof;

FIG. 6 is a right-side elevational view thereof;

FIG. 7 is a top plan view thereof; and,

FIG. 8 is a bottom plan view thereof.

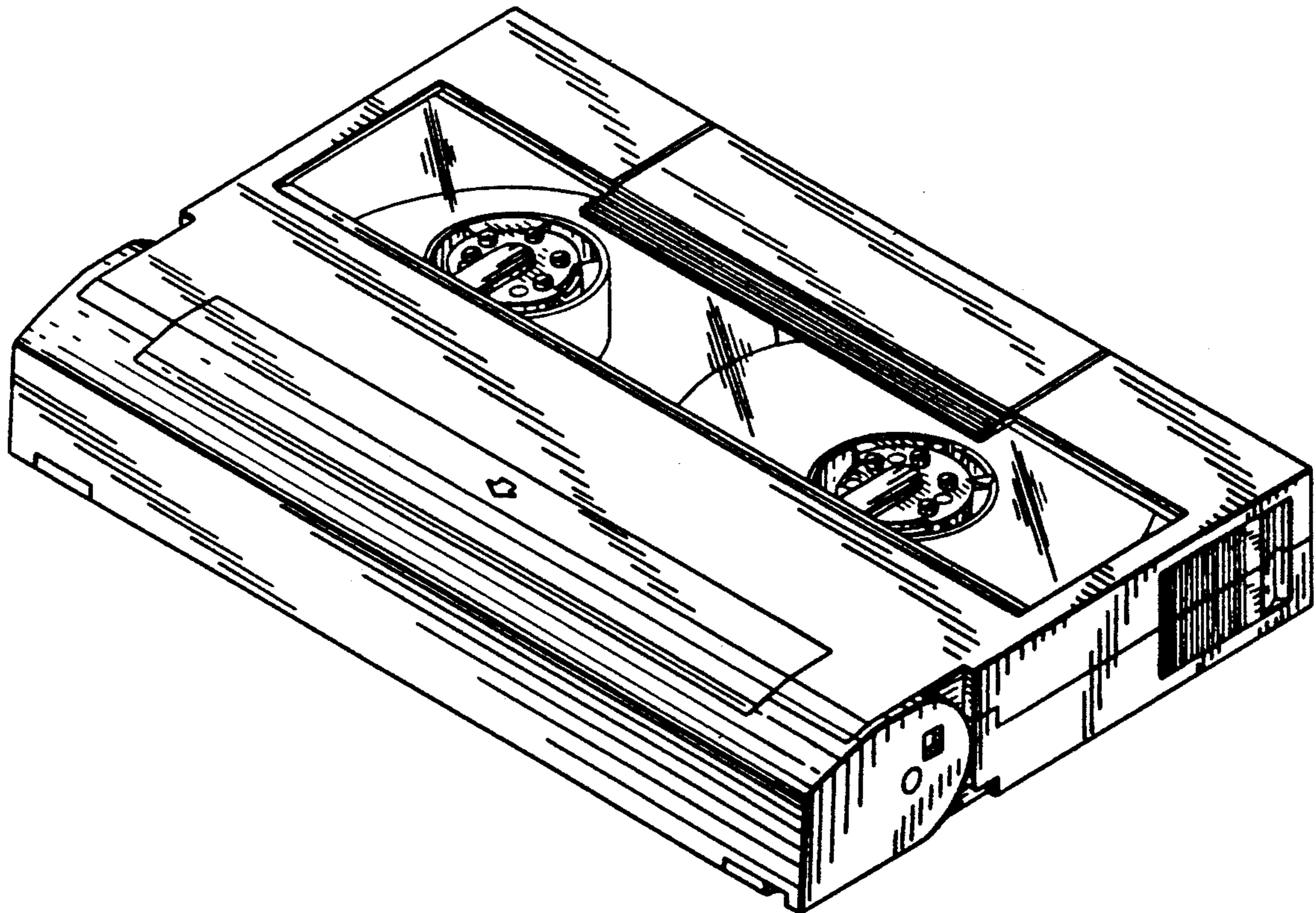

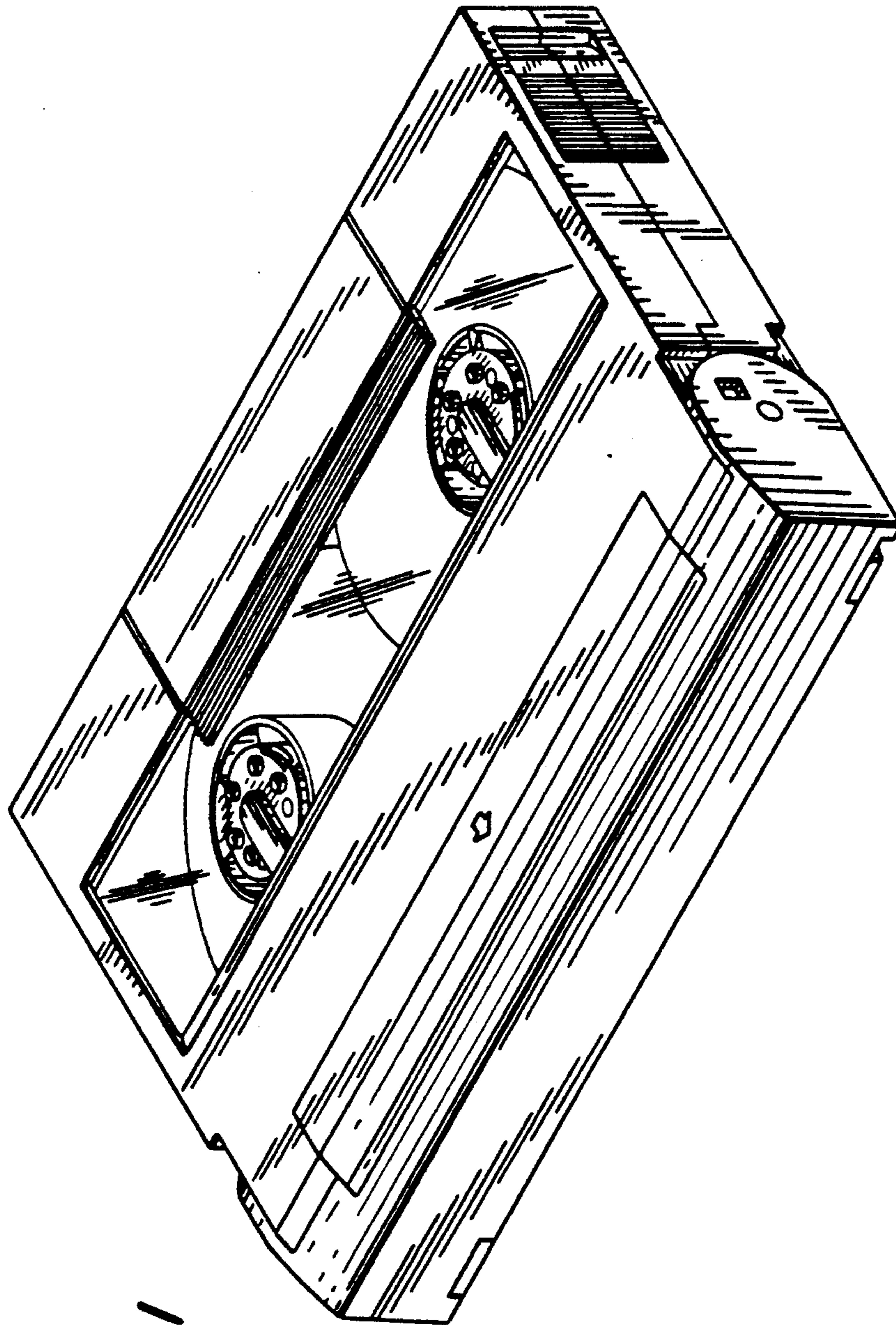

FIG. 1

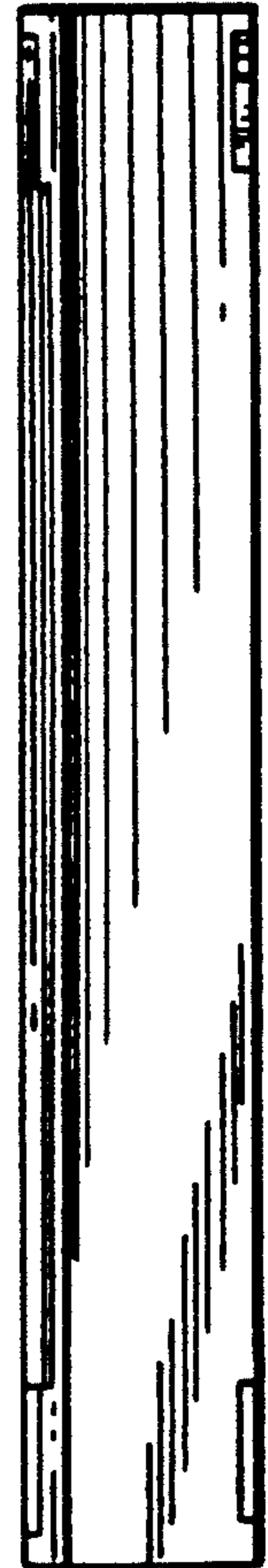

FIG. 3

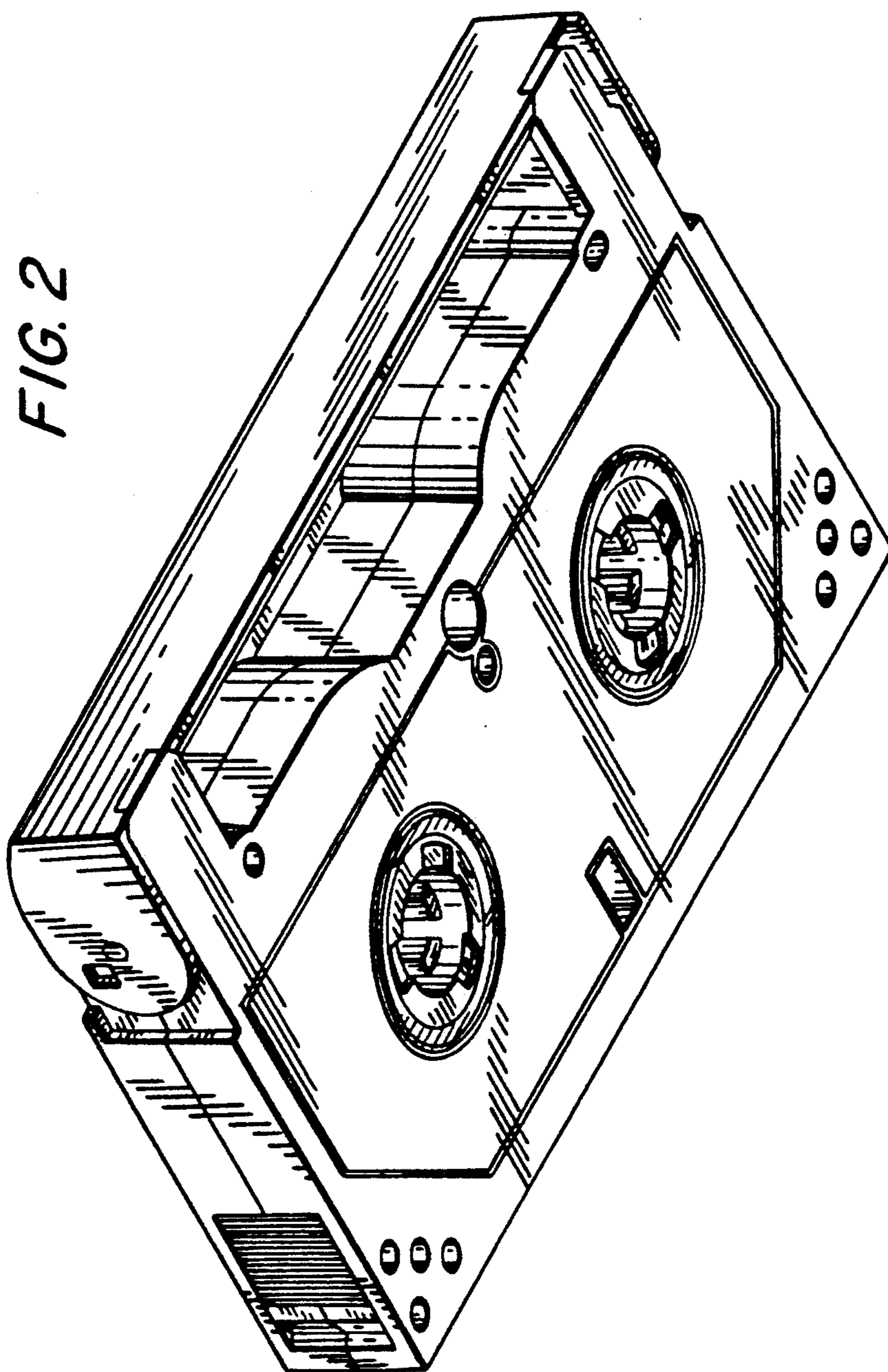

FIG. 5

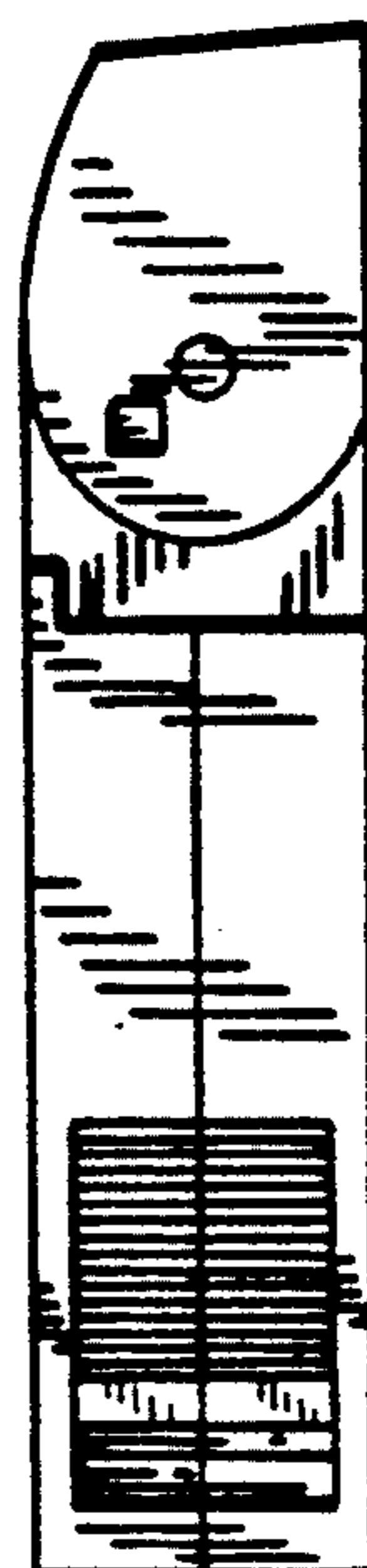

FIG. 4

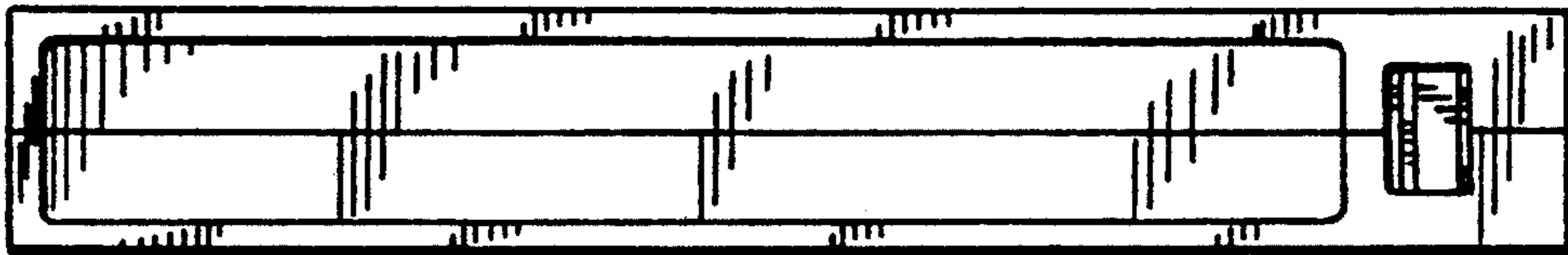
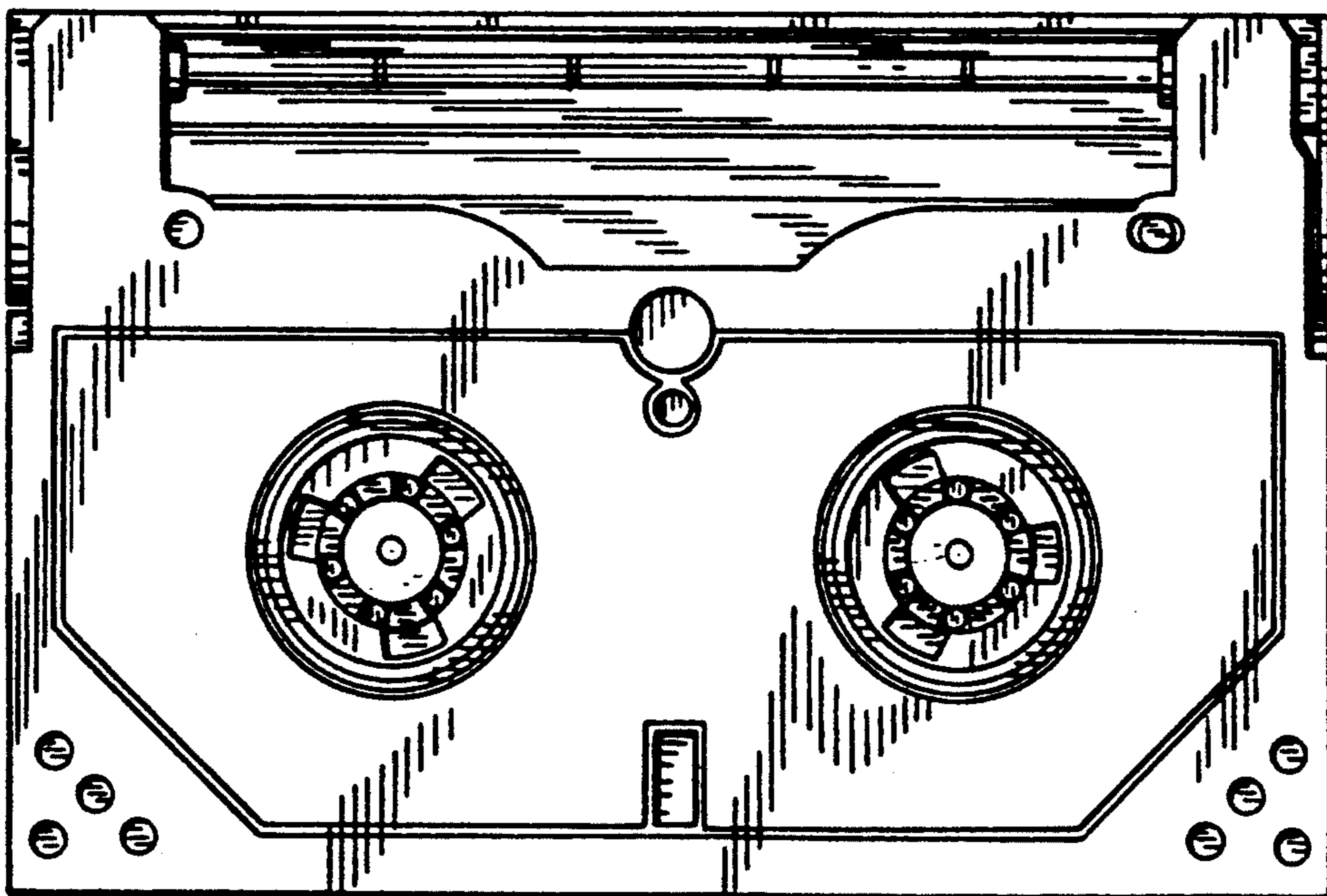
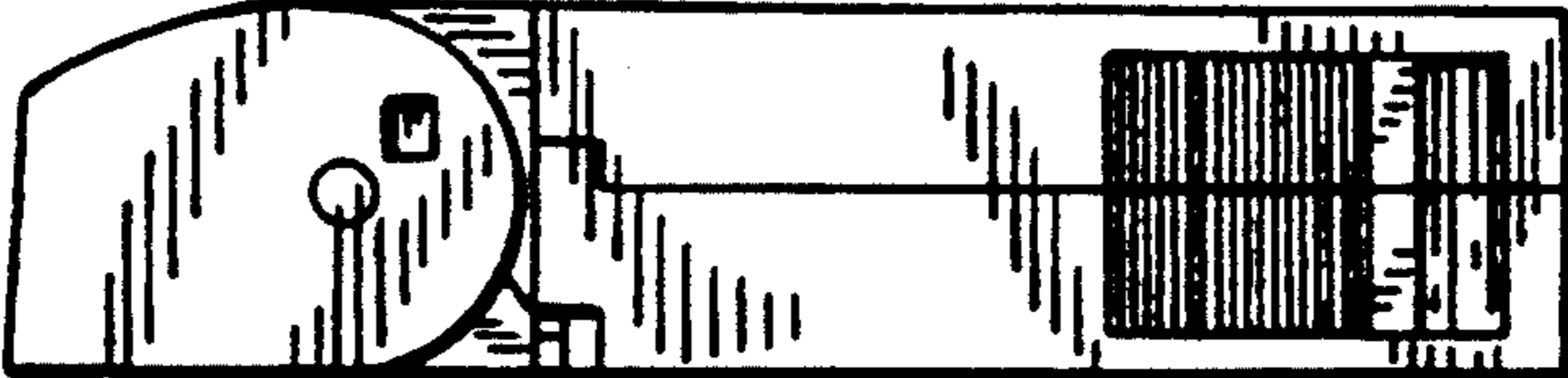

FIG. 8



*FIG. 6*



*FIG. 7*

